

# Sprinklers, Valves and Accessories

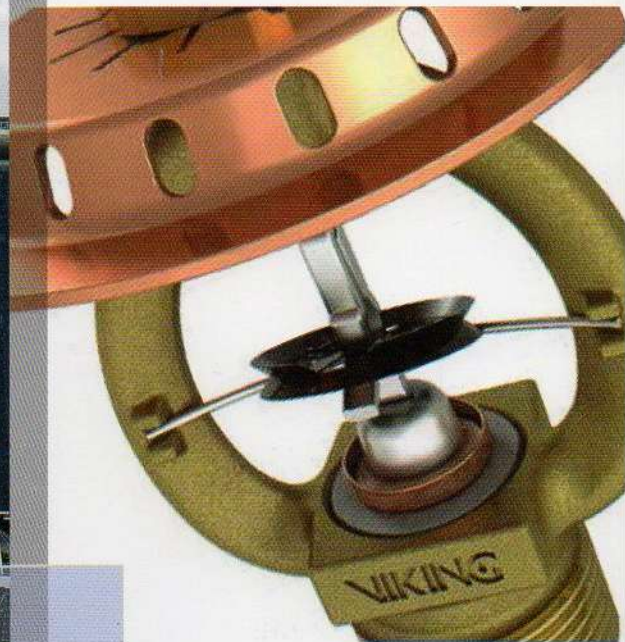

# Standard coverage sprinkler

## Quick Reference Guide

This guide is intended for general reference only. Prior to the design, layout, and/or installation of any sprinkler system, please refer to Viking's technical documentation and always consult with the AHJ. Viking makes no representation or warranty as to whether following this guide will satisfy any rule or requirement. Please visit [www.vikinggroupinc.com](http://www.vikinggroupinc.com) for the most current technical data and product specifications. All products must be installed in accordance with the manufacturer's current installation instructions. Viking reserves the right to change product specifications at any time without notice and without incurring obligation.



## Light, Ordinary, and Extra Hazard

### Standard Response

	Recessed Pendant	Concealed Pendant	Upright	Conventional	Stainless Steel Upright	Stainless Steel Recessed Pendant
5.6 K	VK102 Temp Range 135-500°F  GB ★	VK492 Temp Range 155-200°F  GB	VK100 Temp Range 135-500°F  GB ★	VK118 Temp Range 155-360°F  GB	VK130 Temp Range 155-500°F  GB	VK132 Temp Range 155-500°F  GB
8.0 K	VK202 Temp Range 155-500°F  GB ★	VK202-D (Domed) Temp Range 155-200°F  GB	VK200 Temp Range 155-500°F  GB ★	VK120 Temp Range 155-360°F  GB		
11.2 K	VK536 Temp Range 155-286°F  GB		VK530 Temp Range 155-286°F  GB			

GB - Glass Bulb  
FL - Fusible Link  
★ - Also available in fusible link version.















(NOTE) The above photos are for illustrative purposes only and might not exactly match the sprinkler indicated. Always refer to the technical documentation on Viking's web site for product dimensions and physical characteristics.

- Viking sprinklers are available from the factory with three wraps of PTFE tape applied to the threads at an additional charge. To order, add a "T" to the end of the part number. See list price book for pricing details.
- Many Viking sprinklers are offered in a "Cocoon" option, which includes the sprinkler, protective cap or clip, and two-piece escutcheon. The escutcheon's adapter is threaded to the sprinkler and the entire unit is then protected by a plastic cap. Outer escutcheon rings are included in a separate box.
- Select 8.0 and 11.2 K factor sprinklers are available with ½ NPT thread size FOR REPLACEMENT ONLY.
- The maximum working pressure for high pressure sprinklers is 250 psi, unless otherwise indicated.
- Wax coatings are available on select standard response sprinklers up to and including 286°F. The standard finish is brass.
- Cover plates and escutcheons are sold separately. Sprinklers, escutcheons, and cover plates are available in custom colors at an additional charge. See pages F-8 and F-9 of Viking's list price book for details.
- Polyester and PTFE sprinklers are suitable for decorative applications and are UL Listed for corrosion resistance.
- For corrosion resistance, Viking also offers several sprinklers that are UL Listed with Electroless Nickel PTFE (ENT) coating.

**Mirage® is a registered trademark of The Viking Corporation**

## Light and Ordinary Hazard

### Quick Response

	Recessed Pendant	Domed Concealed Pendant	Concealed Pendant	Upright	Horizontal Sidewall	Flat Concealed Horizontal Sidewall
5.6 K	VK302 Temp Range 135-286°F  GB ★	VK302-D Temp Range 155-200°F  GB	VK462 Temp Range 155-200°F  GB	VK300 Temp Range 135-286°F  GB ★	VK305 Temp Range 155-286°F  GB ★	VK481 Temp Range 165-220°F  FL
8.0 K	VK352 Temp Range 155-286°F  GB ★	VK352-D Temp Range 155-200°F  GB ★	VK464 Temp Range 155-200°F  GB	VK350 Temp Range 155-286°F  GB ★	VK360 Temp Range 135-200°F  GB	
11.2 K	VK377 Temp Range 155-286°F  GB		VK469 Temp Range 165-205°F  FL	VK531 Temp Range 155-286°F  GB ★		

(NOTE) The above photos are for illustrative purposes only and might not exactly match the sprinkler indicated. Always refer to the technical documentation on Viking's web site for product dimensions and physical characteristics.

### Additional Sprinklers

	Conventional	Flush Style	Stainless Steel Upright/Pendant	Mirage® Concealed (non-ferrous)	Mirage® Concealed (high pressure)	Mirage® Concealed (adjustable)
5.6 K	VK310 GB ★ FL	VK402	VK338 VK339 GB	VK462-MRI GB	VK463 GB	VK462-ADJ GB
8.0 K	VK354 GB ★			VK464-MRI GB		

	High Pressure Recessed Pendant	High Pressure Upright	High Pressure Horizontal Sidewall
5.6 K	VK 317 GB ★	VK315 GB ★	VK319 GB ★

GB - Glass Bulb  
FL - Fusible Link  
★ - Also available in fusible link version.

## Light and Ordinary Hazard

### Standard Response

	Flush Style <sup>1</sup>	High Pressure Recessed Pendant	High Pressure Upright	High Pressure Horizontal Sidewall
5.6 K	VK400 (p/n 06679B) FL	VK122 (p/n 09992) GB	VK124 (p/n 09993) GB	VK116 (p/n 09849) GB

\* Please refer to the "Light, Ordinary, and Extra Hazard" table on page 2 for additional sprinkler options.

## Light Hazard Only

### Quick Response

	Recessed Pendant	Flat Concealed Pendant	Mirage Adjustable Concealed	Upright	Horizontal Sidewall	Vertical Sidewall
2.8 K	VK329 Temp Range 155-286°F  GB ★	VK461 Temp Range 155-200°F  GB	VK461-ADJ Temp Range 155-200°F  GB	VK325 Temp Range 155-286°F  GB ★	VK333 Temp Range 155-286°F  GB ★	
4.2 K	VK331 Temp Range 155-286°F  GB ★	VK465 Temp Range 155-200°F  GB	VK465-ADJ Temp Range 155-200°F  GB	VK327 Temp Range 155-286°F  GB ★		
5.6 K	*	*	*	*	*	VK306 (p/n 12983) Temp Range 155-286°F  GB ★

\* Please refer to the "Quick Response" table on the preceding page for additional sprinkler options.

(NOTE) The above photos are for illustrative purposes only and might not exactly match the sprinkler indicated. Always refer to the technical documentation on Viking's web site for product dimensions and physical characteristics.

### Additional Sprinklers

	High Pressure Recessed Pendant	High Pressure Upright	High Pressure Horizontal Sidewall
2.8 K	GB VK342 (p/n 12290) ★	GB VK340 (p/n 12286) ★	GB VK344 (p/n 12287) ★

GB - Glass Bulb

FL - Fusible Link

★ - Also available in fusible link version.

#### Flat Cover Plate – Pendant

(VK461, VK462, VK463, VK464, VK465)

Standard diameter (2-3/4") – base part number 13504

Large diameter (3-1/4") – base part number 13642

Square cover plate – base part number 15394

#### Flat Cover Plate – Pendant (ELO)

(VK469, VK632 EC, VK538 EC)

Large diameter (3-1/4") – base part number 15765

#### Flat Cover Plate – Sidewall (VK481)

Base part number 16207

#### Domed Cover Plate

(VK102-D, VK202-D, VK302-D, VK352-D)

Base part number 12381

#### Escutcheons (recessed pendant sprinklers)

1/2" slip-on (2 piece) – base part number 06419

3/4" slip-on (2 piece) – base part number 06420

1/2" threaded (2 piece) – base part number 11038

3/4" threaded (2 piece) – base part number 11625







1/2" std flat escutcheon – base part number 02960

3/4" std flat escutcheon – base part number 05464

Ceiling rings for VK400/VK402 flush pendants sold separately. See Viking list price book for details.

\*See back panel for available temperature and finishes, and corresponding part number suffixes

### Select Sprinkler Wrenches









	Part #	10896W/B
	Use with all frame-style sprinklers and spray nozzles	
	Part #	16036W/B
	Use with recessed pendant sprinklers with protective caps	
	Part #	13577W/B
	Use with domed concealed pendant, wax coated, and recessed pendant sprinklers with protective shields	
	Part #	13655W/B
	Use with recessed HSW sprinklers with protective shields and domed concealed HSW sprinklers	
Heavy Duty	Part #	14047W/B
	Use with Mirage commercial concealed pendant sprinklers	
Light Duty	Part #	14031
	Use with Mirage commercial concealed pendant sprinklers	

Light Hazard Only Sprinklers continued from page 4

## Light Hazard Only

### Standard Response

Starting with the 1996 edition of NFPA 13, quick response type sprinklers are required to be used in all Light Hazard Occupancies, with exceptions for existing systems that have standard response sprinklers.

	Recessed Pendant	Upright	Horizontal Sidewall	High Pressure Recessed Pendant	High Pressure Upright	High Pressure Horizontal Sidewall
2.8 K	VK003 Temp Range 155-360°F  GB	VK001 Temp Range 155-360°F  GB		VK023 Temp Range 155-360°F  GB	VK021 Temp Range 155-360°F  GB	VK015 Temp Range 155-360°F  GB
4.2 K	VK004 Temp Range 155-360°F  GB	VK002 Temp Range 155-360°F  GB				
5.6 K	*	*	VK104 Temp Range 155-360°F  GB	*	*	*

\* Please refer to the "Quick Response" table on the preceding page for additional sprinkler options.



(NOTE) The above photos are for illustrative purposes only and might not exactly match the sprinkler indicated. Always refer to the technical documentation on Viking's web site for product dimensions and physical characteristics.

### Additional Sprinklers

	Vertical Sidewall
5.6 K GB	VK106

GB - Glass Bulb  
FL - Fusible Link  
★ - Also available in fusible link version.

To order, add desired finish (f) and temperature (t) suffix to end of base part number.

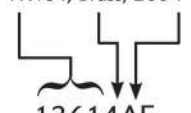
Example 1 [base(f)(t)]	Example 2 [base(f)(t)]	Example 3 [base(f)(t)]
VK530, Chrome, 155°F	VK360, White, 175°F	VK464, Brass, 200°F
 09679FB	 15591MD/W	 13614AE

Temp Suffixes (t)		Finish Suffixes (f)	
135°F	A	Brass	A
155°F	B	Chrome	F
165°F	C	White-Poly	M-/W
175°F	D	Black Poly	M-/B
200°F / 205°F	E	Wax Coated	C
280°F / 286°F	G	Poly w/Wax	V-/W
360°F	H	ENT*	JN
500°F	L		
Open	Z		

\*Electroless Nickel PTFE

# Commercial Extended Coverage Sprinkler

## Quick Reference Guide

This guide is intended for general reference only. Prior to the design, layout, and/or installation of any sprinkler system, please refer to Viking's technical documentation and always consult with the AHJ. Viking makes no representation or warranty as to whether following this guide will satisfy any rule or requirement. Please visit [www.vikinggroupinc.com](http://www.vikinggroupinc.com) for the most current technical data and product specifications. All products must be installed in accordance with the manufacturer's current installation instructions. Viking reserves the right to change product specifications at any time without notice and without incurring obligation.



The design data presented in this document is in accordance with each sprinkler's cULus listing. Design data for other approval agencies can be found on the product's technical datasheet.

### Pendent and Recessed Pendent Sprinklers

#### 5.6 (81) K-factor



**VK600, Part No. 06778B**  
 Technical datasheet Sprinkler 81a

- Listed to 175 psi (12 bar)
- 1/2" NPT (15mm)
- Light Hazard
- Standard Response - 155°F/68°C, 175°F/79°C
- Quick Response - 135°F/57°C, 155°F/68°C, 175°F/79°C
- Standard Wrench - 10896W/B, Recessed Wrench - 13577W/B

Coverage Area ft (m)	Flow gpm (lpm)	Pressure psi (bar)
-------------------------	-------------------	-----------------------

16 x 16 <sup>1</sup> (4.9x4.9)	26 (98.4)	21.6 (1.49)
18 x 18 <sup>1</sup> (5.5x5.5)	33 (124.9)	34.7 (2.39)
20 x 20 <sup>2,3</sup> (6.1x6.1)	40 (151.4)	51.0 (3.52)

<sup>1</sup> cULus listed for quick response only. FM approved for quick response.  
<sup>2</sup> cULus quick response listing available in 135°F/57°C only. FM quick response listing includes 135°F/57°C, 155°F/68°C, and 175°F/79°C.  
<sup>3</sup> Standard response listing also available in 175°F/79°C.  
 \* See technical datasheet for expanded FM approval criteria.

#### 5.6 (81) K-factor



**VK604, Part No. 10335**  
 Technical datasheet Sprinkler 90e

- Listed to 175 psi (12 bar)
- VK610 (p/n 12294) Listed for high pressure; 250 psi (17.2 bar)
- 1/2" NPT (15mm)
- Light Hazard
- Standard Response - 155°F/68°C
- Quick Response - 135°F/57°C, 155°F/68°C, 175°F/79°C
- Standard Wrench - 10896W/B, Recessed Wrench - 13577W/B

16 x 16 <sup>1</sup> (4.9x4.9)	26 (98.4)	21.6 (1.49)
18 x 18 (5.5x5.5)	33 (124.9)	34.7 (2.40)
20 x 20 <sup>2</sup> (6.1x6.1)	40 (151.4)	51.0 (3.52)

<sup>1</sup> Available only for quick response.  
<sup>2</sup> Standard response listing also available in 175°F/79°C.

#### 8.0 (115) K-factor



**VK602, Part No. 18262**  
 Technical datasheet Sprinkler 81a

- Listed to 175 psi (12 bar)
- 3/4" NPT (20mm)
- Light Hazard
- Standard Response - 155°F/68°C, 175°F/79°C
- Quick Response - 135°F/57°C, 155°F/68°C, 175°F/79°C
- Standard Wrench - 10896W/B, Recessed Wrench - 13577W/B

16 x 16 <sup>1</sup> (4.9x4.9)	26 (98.4)	10.6 (0.73)
18 x 18 <sup>1</sup> (5.5x5.5)	33 (124.9)	17.0 (1.17)
20 x 20 <sup>2</sup> (6.1x6.1)	40 (151.4)	25.0 (1.72)

<sup>1</sup> cULus listed for quick response only. FM approved for quick response.  
<sup>2</sup> cULus quick response listing available in 135°F/57°C only. FM quick response listing includes 135°F/57°C, 155°F/68°C, and 175°F/79°C.  
 \* See technical datasheet for expanded FM approval criteria.

#### 11.2 (161) K-factor



**VK608, Part No. 08339**  
 Technical datasheet Sprinkler 85a

- Listed to 175 psi (12 bar)
- 3/4" NPT (20mm)
- Light Hazard
- Standard Response - 155°F/68°C
- Quick Response - 135°F/57°C, 155°F/68°C, 175°F/79°C
- Standard Wrench - 05118CW/B, Recessed Wrench - 11663W/B
- Listed with concrete tees up to 30" (762mm) in depth

16 x 16 <sup>1</sup> (4.9x4.9)	30 (113.6)	7.2 (0.50)
18 x 18 <sup>1</sup> (5.5x5.5)	33 (124.9)	8.7 (0.60)
20 x 20 <sup>2</sup> (6.1x6.1)	40 (151.4)	12.8 (0.88)

<sup>1</sup> Available only for quick response.  
<sup>2</sup> cULus quick response listing in 135°F/57°C and 175°F/79°C only. FM quick response listing also includes 155°F/68°C.  
 \* See technical datasheet for expanded FM approval criteria.

Pendent and Recessed Pendent Sprinklers continued from page 6

**11.2 (161) K-factor**



**VK534, Part No. 08340**  
**Technical datasheet Sprinkler 83a**

- QR Listing for Light and Ordinary Hazard may allow for design area reduction.
- Listed to 175 psi (12 bar)
- 3/4" NPT (20mm)
- Light/Ordinary Hazard
- Standard Response - 155°F/68°C, 175°F/79°C, 200°F/93°C, 286°F/141°C
- Quick Response - 135°F/57°C, 155°F/68°C, 175°F/79°C, 200°F/93°C, 286°F/141°C
- Standard Wrench - 05118CW/B, Recessed Wrench - 11663W/B
- Listed with concrete tees up to 30" (762mm) in depth
- Available with ENT coating (Nickel PTFE) for corrosion resistance

Coverage Area ft (m)	Flow gpm (lpm)	Pressure psi (bar)
<b>LIGHT HAZARD</b>		
16 x 16 <sup>1</sup> (4.9x4.9)	30 (113.6)	7.2 (0.50)
18 x 18 <sup>1</sup> (5.5x5.5)	33 (124.9)	8.7 (0.60)
20 x 20 <sup>1</sup> (6.1x6.1)	40 (151.4)	12.8 (0.88)
<b>ORDINARY HAZARD*</b>		
12 x 12 <sup>1</sup> (3.7x3.7)	30 (113.6)	7.2 (0.50)
14 x 14 <sup>1</sup> (4.3x4.3)	30 (113.6)	7.2 (0.50)
16 x 16 <sup>2</sup> (4.9x4.9)	38 (143.9)	11.5 (0.79)
18 x 18 <sup>2</sup> (5.5x5.5)	49 (185.5)	19.1 (1.32)
20 x 20 <sup>2</sup> (6.1x6.1)	60 (227.1)	28.7 (1.98)

<sup>1</sup> Available only for quick response.  
<sup>2</sup> Available only for standard response.  
 \* Design data listed above is for OH Group 1. See technical datasheet for OH Group 2 data.

**14.0 (202) K-factor**



**VK572, Part No. 13722**  
**Technical datasheet Sprinkler 83q**

- QR Listing for Ordinary Hazard may allow for design area reduction
- Listed to 175 psi (12 bar)
- 3/4" NPT (20mm)
- Ordinary Hazard
- Standard/Quick Response - 155°F/68°C, 175°F/79°C, 200°F/93°C, 286°F/141°C
- Standard Wrench - 07297W/B, Recessed Wrench - 13032W/B
- FM Approved for HC1, HC2, and HC3 occupancies
- Listed with concrete tees up to 30" (762mm) in depth
- Available with ENT coating (Nickel PTFE) for corrosion resistance

<b>ORDINARY HAZARD*</b>		
12 x 12 <sup>1</sup> (3.7x3.7)	39 (147.6)	7.8 (0.54)
14 x 14 <sup>1</sup> (4.3x4.3)	39 (147.6)	7.8 (0.54)
16 x 16 <sup>2</sup> (4.9x4.9)	39 (147.6)	7.8 (0.54)
18 x 18 <sup>2</sup> (5.5x5.5)	49 (185.5)	12.3 (0.85)
20 x 20 <sup>2</sup> (6.1x6.1)	60 (227.1)	18.4 (1.27)

<sup>1</sup> Available only for quick response.  
<sup>2</sup> Available only for standard response.  
 \* See technical datasheet for FM approval criteria.  
 \*\* Design data listed above is for OH Group 1. See technical datasheet for OH Group 2 data.

**Upright Sprinkler**

**11.2 (161) K-factor**



**VK532, Part No. 08687**  
**Technical datasheet Sprinkler 83a**

- QR Listing for Light and Ordinary Hazard may allow for design area reduction
- 3/4" NPT (20mm)
- Light/Ordinary Hazard
- Standard Response - 155°F/68°C, 175°F/79°C, 200°F/93°C, 286°F/141°C
- Quick Response - 135°F/57°C, 155°F/68°C, 175°F/79°C, 200°F/93°C, 286°F/141°C
- Standard Wrench - 05118CW/B
- FM approved for HC1, HC2, and HC3 occupancies
- Listed with concrete tees up to 30" (762mm) in depth
- Available with ENT coating (Nickel PTFE) for corrosion resistance

Coverage Area ft (m)	Flow gpm (lpm)	Pressure psi (bar)
<b>LIGHT HAZARD</b>		
16 x 16 <sup>1</sup> (4.9x4.9)	30 (113.6)	7.2 (0.50)
18 x 18 <sup>1</sup> (5.5x5.5)	33 (124.9)	8.7 (0.60)
20 x 20 <sup>1</sup> (6.1x6.1)	40 (151.4)	12.8 (0.88)
<b>ORDINARY HAZARD*</b>		
12 x 12 <sup>1</sup> (3.7x3.7)	30 (113.6)	7.2 (0.50)
14 x 14 <sup>1</sup> (4.3x4.3)	30 (113.6)	7.2 (0.50)
16 x 16 <sup>2</sup> (4.9x4.9)	38 (143.9)	11.5 (0.79)
18 x 18 <sup>2</sup> (5.5x5.5)	49 (185.5)	19.1 (1.32)
20 x 20 <sup>2</sup> (6.1x6.1)	60 (227.1)	28.7 (1.98)

<sup>1</sup> Available only for quick response.  
<sup>2</sup> Available only for standard response.  
 \* See datasheet for FM approval criteria.  
 \*\* Design data listed above is for OH Group 1. See technical datasheet for Group 2 data.

**14.0 (202) K-factor**



**VK570, Part No. 13840**  
**Technical datasheet Sprinkler 83h**

- QR Listing for Ordinary Hazard may allow for design area reduction
- Listed to 175 psi (12 bar)
- 3/4" NPT (20mm)
- Ordinary Hazard
- Standard/Quick Response - 155°F/68°C, 175°F/79°C, 200°F/93°C, 286°F/141°C
- Standard Wrench - 07297W/B
- Listed with concrete tees up to 30" (762mm) in depth
- Available with ENT coating (Nickel PTFE) for corrosion resistance

<b>ORDINARY HAZARD*</b>		
12 x 12 <sup>1</sup> (3.7x3.7)	39 (147.6)	7.8 (0.54)
14 x 14 <sup>1</sup> (4.3x4.3)	39 (147.6)	7.8 (0.54)
16 x 16 <sup>2</sup> (4.9x4.9)	39 (147.6)	7.8 (0.54)
18 x 18 <sup>2</sup> (5.5x5.5)	49 (185.5)	12.3 (0.85)
20 x 20 <sup>2</sup> (6.1x6.1)	60 (227.1)	18.4 (1.27)

<sup>1</sup> Available only for quick response.  
<sup>2</sup> Available only for standard response.  
 \* Design data listed above is for OH Group 1. See technical datasheet for Group 2 data.

**Additional Design and Application Information**

For systems designed to NFPA 13, water supplies are determined by applying the requirements from Chapter 11, Design Approaches (2013 Edition). Refer to sprinkler data pages on Viking's web site at [www.vikinggroupinc.com](http://www.vikinggroupinc.com) for current technical data, design criteria, and listing/approval information. In some cases, Sprinkler Identification Numbers (SIN) may apply to more than one sprinkler. Please use part numbers when placing orders. *NOTE: The A<sub>s</sub> = S x L method must be used to determine the sprinkler protection area of coverage. (8.5.2.1)*

**Cover Plate Information**

Flat covers are available in white, ivory, black, bright brass, brushed brass, antique brass, polished chrome, brushed chrome and brushed copper standard finishes. Domed covers are available in white, ivory, black and polished chrome. Flat covers are 3-5/16" (84mm) and 2-3/4" (69.8mm) in diameter and the domed covers are 3-1/8" (80mm) in diameter. Square cover plates measure (LxW) 3-5/16" (84mm).

**Special Painted Cover Plates**

In addition to standard finishes, cover plates can be special ordered in over 800 custom colors. Additional charges will apply. Orders covering special painted products are not subject to cancellation except by written permission and then only upon agreement to make payment for work already performed. Viking reserves the right to over ship special painted products produced in excess of order quantity at no charge. No return of these products is allowed.

### Horizontal Sidewall Sprinklers

Standard Response available in 155°F/68°C; Quick Response available in 135°F/57°C, 155°F/68°C and 175°F/79°C

#### 5.6 (81) K-factor



VK605, Part No. 12120  
Technical datasheet Sprinkler 91a

- 1/2" NPT (15mm)
- Light Hazard
- Standard/Quick Response
- 6-12" (152-305mm) deflector distance to ceiling for horizontal ceilings. 4-6" (102-152mm) for ceilings up to 4/12 (18.4°) pitch
- Standard Wrench - 10896W/B, Recessed Wrench - 13655W/B
- Listed for high pressure; 250 psi (17.2 bar) as VK612 (p/n 12295)

Coverage Area ft (m)	Flow gpm (lpm)	Pressure psi (bar)
16 x 16 <sup>1</sup> (4.9x4.9)	26 (98.4)	21.6 (1.49)
16 x 18 <sup>1</sup> (4.9x5.5)	29 (109.8)	26.8 (1.85)
16 x 20 <sup>1</sup> (4.9x6.2)	32 (121.1)	32.7 (2.25)

<sup>1</sup> Also available for sloped ceilings up to 4/12 (18°) pitch with same flows and pressures, installed 4-6" below ceiling.

#### 8.0 (115) K-factor



VK606, Part No. 13005  
Technical datasheet Sprinkler 82a

- 3/4" NPT (20mm)
- Light Hazard
- Quick Response
- Approved for 4-12" (102-305mm) down from ceiling
- Standard Wrench - 10896W/B, Recessed Wrench - 13655W/B
- FM approved up to 16 x 24 (4.9 x 7.3)

16 x 16 (4.9x4.9)	26 (98.4)	10.6 (0.73)
16 x 18 (4.9x5.5)	29 (109.8)	13.1 (0.91)
16 x 20 (4.9x6.2)	32 (121.1)	16.0 (1.10)
16 x 22 <sup>1</sup> (4.9x6.7)	36 (136.3)	20.3 (1.40)
16 x 22 <sup>2</sup> (4.9x6.7)	38 (143.8)	22.6 (1.56)

<sup>1</sup> 4-6" (102-152mm) down from ceiling.

<sup>2</sup> 6-12" (152-305mm) down from ceiling.

\* Flows and pressures listed above are based on UL Listings only. See technical datasheet for FM approval criteria.

#### 8.0 (115) K-factor



VK630, Part No. 13500  
Technical datasheet Sprinkler 80a

- 3/4" NPT (20mm)
- Light Hazard
- Quick Response
- Approved for 4-12" (102-305mm) down from ceiling
- Standard Wrench - 10896W/B, Recessed Wrench - 13655W/B
- Also available in a domed concealed (model p/n 13500A-X)
- Available with ENT coating (Nickel PTFE) for corrosion resistance.

14 x 24 <sup>1</sup> (4.3x7.3)	34 (128.7)	18.1 (1.25)
14 x 24 <sup>2</sup> (4.3x7.3)	36 (136.3)	20.3 (1.40)
14 x 26 <sup>1</sup> (4.3x7.9)	38 (144.0)	22.6 (1.56)
14 x 26 <sup>2</sup> (4.3x7.9)	46 (174.1)	33.1 (2.28)
16 x 16 (4.9x4.9)	26 (98.4)	10.6 (0.73)
16 x 18 (4.9x5.5)	29 (109.8)	13.1 (0.91)
16 x 20 (4.9x6.2)	32 (121.1)	16.0 (1.10)
16 x 22 (4.9x6.7)	36 (136.3)	20.3 (1.40)
16 x 24 (4.9x7.3)	39 (147.6)	23.8 (1.64)
18 x 18 (5.5x5.5)	33 (124.9)	17.0 (1.17)
18 x 20 (5.5x6.2)	36 (136.3)	20.3 (1.40)
18 x 22 (5.5x6.7)	40 (151.4)	25.0 (1.72)

<sup>1</sup> 4-6" (102-152mm) down from ceiling.

<sup>2</sup> 6-12" (152-305mm) down from ceiling.

\* Flows and pressures listed above are based on UL Listings only. See datasheet for FM approval criteria.

#### 8.0 (115) K-factor



VK638, Part No. 17375 (Corridor Sprinkler)  
Technical datasheet Sprinkler 84n

- 3/4" NPT (20mm)
- Light Hazard
- Quick Response
- Standard Wrench - 10896W/B, Recessed Wrench - 13655W/B
- Well suited for hallways, corridors, breeze ways, and other applications requiring a wide spray pattern
- Also available in a domed concealed model (p/n 17375A-X)

28 x 12 <sup>1</sup> (8.5x3.7)	34 (128.7)	18.1 (1.24)
28 x 14 <sup>1</sup> (8.5x4.3)	40 (151.4)	25.0 (1.73)

<sup>1</sup> 4-12" (102-305mm) down from ceiling.

### Flat Plate Concealed Horizontal Sidewall Sprinkler

Cover Plate 3-5/16" (84mm) diameter; Adjustment up to 1/4" (6mm)

#### 8.0 (115) K-factor



VK680, Part No. 17114AC  
Technical datasheet Sprinkler 87n

- 3/4" NPT (20mm)
- Light Hazard
- Quick Response
- Listed for installation 4-3/8 to 12-3/8" (112-314mm) down from ceiling (measured to the center line of sprinkler)
- Wrench - 16208W/R
- Sprinkler 165°F/74°C; Cover 135°F/57°C
- Use cover plate 16207 (sold separately)

Coverage Area ft (m)	Flow gpm (lpm)	Pressure psi (bar)
14 x 22 (4.3x6.7)	31 (117.3)	15.0 (1.04)
16 x 16 (4.9x4.9)	26 (98.4)	10.6 (0.73)
16 x 18 (4.9x5.5)	29 (109.8)	13.1 (0.91)
16 x 20 (4.9x6.2)	32 (121.1)	16.0 (1.10)
16 x 22 (4.9x6.7)	36 (136.3)	20.3 (1.40)
18 x 18 (5.5x5.5)	33 (124.9)	17.0 (1.20)
18 x 20 (5.5x6.2)	36 (136.3)	20.3 (1.40)
18 x 22 (5.5x6.7)	40 (151.4)	25.0 (1.72)



### Mirage® Flat Plate Concealed Pendent Sprinklers

**5.6 (81) K-factor**



VK632, Part No. 14613A  
 Technical datasheet Sprinkler 92a

- 1/2" NPT (15mm)
- Light Hazard
- Wrench: Heavy Duty (14047W/B); Light Duty (14031)
- Quick Response - Sprinkler 135°F/57°C, 155°F/68°C, 175°F/79°C, 200°F/93°C; Cover 135°F/57°C, 165°F/74°C

Coverage Area ft (m)	Flow gpm (lpm)	Pressure psi (bar)
16 x 16 (4.9x4.9)	26 (98.4)	21.6 (1.49)
18 x 18 (5.5x5.5)	33 (124.9)	34.7 (2.39)
20 x 20 <sup>1</sup> (6.1x6.1)	40 (151.4)	51.0 (3.52)

<sup>1</sup> Available only for 135°F/57°C and 175°F/79°C.

**8.0 (115) K-factor**



VK634, Part No. 14535A  
 Technical datasheet Sprinkler 92a

- 3/4" NPT (20mm)
- Light Hazard
- Wrench: Heavy Duty (14047W/B); Light Duty (14031)
- Quick Response - Sprinkler 135°F/57°C, 155°F/68°C, 175°F/79°C, 200°F/93°C; Cover 135°F/57°C, 165°F/74°C

16 x 16 (4.9x4.9)	26 (98.4)	10.6 (0.73)
18 x 18 (5.5x5.5)	33 (124.9)	17.0 (1.17)
20 x 20 <sup>1</sup> (6.1x6.1)	40 (151.4)	25.0 (1.72)

<sup>1</sup> Available only for 135°F/57°C and 175°F/79°C.

**11.2 (161) K-factor**



VK636, Part No. 16102A  
 Technical datasheet Sprinkler 89a

- 3/4" NPT (20mm)
- Light Hazard
- Wrench: Heavy Duty (15467W/B); Light Duty (15466)
- Quick Response - Sprinkler 165°F/74°C, 205°F/96°C; Cover 135°F/57°C, 165°F/74°C
- Use ELO cover plate 15765\_ (3-5/16" diameter)

16 x 16 (4.9x4.9)	30 (113.6)	7.2 (0.50)
18 x 18 (5.5x5.5)	33 (124.9)	8.7 (0.60)
20 x 20 <sup>1</sup> (6.1x6.1)	40 (151.4)	12.8 (0.88)

**11.2 (161) K-factor**



VK538, Part No. 17115A  
 Technical datasheet Sprinkler 89h

- 3/4" NPT (20mm)
- Ordinary Hazard
- QR Listing for Ordinary Hazard may allow for design area reduction
- Wrench: Heavy Duty (15467W/B); Light Duty (15466)
- Quick Response - Sprinkler 165°F/74°C, 205°F/96°C; Cover 135°F/57°C, 165°F/74°C
- Use ELO cover plate 15765\_ (3-5/16" diameter)

ORDINARY HAZARD*		
14 x 14 (4.3x4.3)	30 (113.6)	7.2 (0.50)
16 x 16 (4.9x4.9)	38 (143.9)	11.5 (0.79)
18 x 18 (5.5x5.5)	49 (185.5)	19.1 (1.32)
20 x 20 <sup>1</sup> (6.1x6.1)	60 (227.1)	28.7 (1.98)

<sup>1</sup> Also listed as standard response.

\* Design data listed above is for OH Group 1. See technical datasheet for Group 2 data.

Note: Base part numbers for cover plates are 13504 for standard diameter, 13642 for large diameter, 15394 for square, and 15765 for ELO. (Sold Separately)  
 When ordering, please add appropriate finish and temperature suffix (135°F/57°C = "A"; 165°F/74°C = "C") to base part number. Refer to Viking's list price book for ordering details.

### Domed Concealed Pendent Sprinklers

**5.6 (81) K-factor**



VK614-D, Part No. 06778BA-X  
 Technical datasheet Sprinkler 88a

- 1/2" NPT (15mm)
- Light Hazard
- Standard Wrench - 13577W/B
- Standard Response - Sprinkler 155°F/68°C; Cover 135°F/57°C
- Quick Response - Sprinkler 135°F/57°C, 155°F/68°C, 175°F/79°C; Cover 135°F/57°C, 165°F/74°C

Coverage Area ft (m)	Flow gpm (lpm)	Pressure psi (bar)
16 x 16 <sup>1</sup> (4.9x4.9)	26 (98.4)	21.6 (1.49)
18 x 18 (5.5x5.5)	33 (124.9)	34.7 (2.39)
20 x 20 (6.1x6.1)	40 (151.4)	51.0 (3.52)

<sup>1</sup> Available only for quick response.

**8.0 (115) K-factor**



VK616-D, Part No. 07077A-X  
 Technical datasheet Sprinkler 88a

- 3/4" NPT (20mm)
- Light Hazard
- Standard Wrench - 13577W/B
- Standard Response - Sprinkler 155°F/68°C; Cover 135°F/57°C
- Quick Response - Sprinkler 135°F/57°C, 155°F/68°C, 175°F/79°C; Cover 135°F/57°C, 165°F/74°C

16 x 16 <sup>1</sup> (4.9x4.9)	26 (98.4)	10.6 (0.73)
18 x 18 (5.5x5.5)	33 (124.9)	17.0 (1.17)
20 x 20 (6.1x6.1)	40 (151.4)	25.0 (1.72)

<sup>1</sup> Available only for quick response.

**11.2 (161) K-factor**



VK618-D, Part No. 08339A-X  
 Technical datasheet Sprinkler 86a

- 3/4" NPT (20mm)
- Light Hazard
- Standard Wrench - 11663W/B
- Standard Response - Sprinkler 155°F/68°C; Cover 135°F/57°C
- Quick Response - Sprinkler 135°F/57°C, 155°F/68°C, 175°F/79°C; Cover 135°F/57°C, 165°F/74°C

16 x 16 <sup>1</sup> (4.9x4.9)	30 (113.6)	7.2 (0.50)
18 x 18 (5.5x5.5)	33 (124.9)	8.7 (0.60)
20 x 20 (6.1x6.1)	40 (151.4)	12.8 (0.88)

<sup>1</sup> Available only for quick response.

Note: Base part number for cover plates is 12381. (Sold Separately)  
 When ordering, please add appropriate finish and temperature suffix (135°F/57°C = "A"; 165°F/74°C = "C") to base part number. Refer to Viking's list price book for ordering details.

## Storage Sprinkler U.S. Quick Reference Guide

This guide is intended for general reference only. Prior to the design, layout, and/or installation of any sprinkler system, please refer to Viking's technical documentation and always consult with the AHJ. Viking makes no representation or warranty as to whether following this guide will satisfy any rule or requirement. Please visit [www.vikinggroupinc.com](http://www.vikinggroupinc.com) for the most current technical data and product specifications. All products must be installed in accordance with the manufacturer's current installation instructions. Viking reserves the right to change product specifications at any time without notice and without incurring obligation.



### Early Suppression Fast Response (ESFR) Sprinklers

#### 14.0 (202) K-factor



#### VK520, ESFR Upright

Base Part Number:	10625
Technical Datasheet:	F_060298
NPT Thread:	3/4 in

- Protects up to 35 ft (10,7 m) high buildings without using in-rack sprinklers
- Upright design provides more options for designing around obstructions
- Install directly onto system piping up to 3 in (75 mm) diameter pipe
- Easy to retrofit into existing upright sprinkler systems
- Can be installed on same branch line as K14 ESFR pendent sprinklers

NFPA 13 - Required Minimum Flow (GPM) - Single-Row, Double-Row, and Multi-Row Rack Storage (without solid shelves)<sup>1</sup>

ceiling height (ft) >	45'					40'					35'			32'	30'		25'
storage height (ft) >	40'	35'	30'	25'	20'	35'	30'	25'	20'	30'	25'	20'	25'	25'	20'	20'	
Class I-IV Commodity										1455	1455	1455	1302	1188	1188	1188	
Cartoned Nonexpanded Plastic										1455	1455	1455	1302	1188	1188	1188	
Cartoned Expanded Plastic														1188	1188	1188	

<sup>1</sup> Required flow per sprinkler calculated using  $Q=K^*(\sqrt{p})$  multiplied by number of design sprinklers (12)

#### 14.0 (202) K-factor



#### VK500, ESFR Pendent

Base Part Number:	10284
Technical Datasheet:	F_060198
NPT Thread:	3/4 in

- Protects up to 35 ft (10,7 m) high buildings without using in-rack sprinklers
- Sprinklers may be spaced up to 12 ft (3,7 m) for buildings up to 30 ft (9,1 m)
- Coverage area per sprinkler may not exceed 100 ft<sup>2</sup> (9,3 m<sup>2</sup>)
- Available in 165° F and 205° F temperature ratings

NFPA 13 - Required Minimum Flow (GPM) - Single-Row, Double-Row, and Multi-Row Rack Storage (without solid shelves)<sup>1</sup>

ceiling height (ft) >	45'					40'					35'			32'	30'		25'
storage height (ft) >	40'	35'	30'	25'	20'	35'	30'	25'	20'	30'	25'	20'	25'	25'	20'	20'	
Class I-IV Commodity										1455	1455	1455	1302	1188	1188	1188	
Cartoned Nonexpanded Plastic										1455	1455	1455	1302	1188	1188	1188	
Cartoned Expanded Plastic													1302	1188	1188	1188	
Exposed Nonexpanded Plastic										1455	1455	1455	1302	1188	1188	1188	

<sup>1</sup> Required flow per sprinkler calculated using  $Q=K^*(\sqrt{p})$  multiplied by number of design sprinklers (12)

#### 14.0 (202) K-factor



#### VK502, ESFR Dry Pendent

Threaded Part Number:*	18177
Grooved Part Number:*	18176
Technical Datasheet:	F_042012
NPT Thread:	1-1/2 in
Grooved:	2 in

- Protects up to 35 ft (10,7 m) high buildings without using in-rack sprinklers
- INSTALL ON WET SYSTEMS ONLY (not approved for dry/preaction systems)
- Uses same design criteria as standard 14.0 (202) K-factor ESFR pendent
- Includes two dry sprinkler insulation boots (p/n 19330M/W)
- Offered with either a threaded or grooved connection
- Available in 165° F temperature rating

NFPA 13 - Required Minimum Flow (GPM) - Single-Row, Double-Row, and Multi-Row Rack Storage (without solid shelves)<sup>1</sup>

ceiling height (ft) >	45'					40'					35'			32'	30'		25'
storage height (ft) >	40'	35'	30'	25'	20'	35'	30'	25'	20'	30'	25'	20'	25'	25'	20'	20'	
Class I-IV Commodity										1455	1455	1455	1302	1188	1188	1188	
Cartoned Nonexpanded Plastic										1455	1455	1455	1302	1188	1188	1188	
Cartoned Expanded Plastic													1302	1188	1188	1188	
Exposed Nonexpanded Plastic										1455	1455	1455	1302	1188	1188	1188	

\*Standard length is 36-5/8". Also available in lengths of 18-5/8", 24-5/8", and 30-5/8". Refer to Viking's List Price Book for ordering information.

<sup>1</sup> Required flow per sprinkler calculated using  $Q=K^*(\sqrt{p})$  multiplied by number of design sprinklers (12)

Storage Sprinkler U.S. Quick Reference Guide

ESFR Sprinklers continued from Page 10

Early Suppression Fast Response (ESFR) Sprinklers

Viking ESFR sprinklers with K-factor of 16.8 and greater successfully meet the new UL 1767 test standard and compliance program for high clearance storage arrangements.

16.8 (242) K-factor



VK503, ESFR Pendent

Base Part Number:	14073
Technical Datasheet:	F_120106
NPT Thread:	3/4 in

- Protects up to 35 ft (10,7 m) high piled storage without using in-rack sprinklers in buildings with 40 ft (12,2 m) high ceilings
- Requires lower starting pressures than VK500 K14 (202) ESFR pendent
- Approved for up to 45 ft (13,7 m) ceilings with one row of in-rack sprinklers
- Available in 165° F and 205° F temperature ratings

NFPA 13 - Required Minimum Flow (GPM) - Single-Row, Double-Row, and Multi-Row Rack Storage (without solid shelves) <sup>1</sup>															
ceiling height (ft) >	45'					40'				35'			32'	30'	25'
storage height (ft) >	40'	35'	30'	25'	20'	35'	30'	25'	20'	30'	25'	20'	25'	20'	20'
Class I-IV Commodity	1600	1600	1600	1600	1600	1454	1454	1454	1454	1454	1454	1454	1307	1193	1193
Cartoned Nonexpanded Plastic	1600	1600	1600	1600	1600	1454	1454	1454	1454	1454	1454	1454	1307	1193	1193
Cartoned Expanded Plastic													1307	1193	1193
Exposed Nonexpanded Plastic	1600	1600	1600	1600	1600	1454	1454	1454	1454	1454	1454	1454	1307	1193	1193

<sup>1</sup> Required flow per sprinkler calculated using  $Q=K^*(\sqrt{p})$  multiplied by number of design sprinklers (12)

<sup>2</sup> Requires one row of in-rack sprinklers

16.8 (242) K-factor



VK504, ESFR Dry Pendent

Threaded Part Number:*	19016
Grooved Part Number:*	19015
Technical Datasheet:	F_062613
NPT Thread/Grooved:	1-1/2 in

- Protects up to 35 ft (10,7 m) high piled storage without using in-rack sprinklers in buildings with 40 ft (12,2 m) high ceilings
- Available in 165° F and 205° F temperature ratings
- Includes two dry sprinkler insulation boots (p/n 19330M/W)
- INSTALL ON WET SYSTEMS ONLY (not approved for dry/preaction systems)

NFPA 13 - Required Minimum Flow (GPM) - Single-Row, Double-Row, and Multi-Row Rack Storage (without solid shelves) <sup>1</sup>															
ceiling height (ft) >	45'					40'				35'			32'	30'	25'
storage height (ft) >	40'	35'	30'	25'	20'	35'	30'	25'	20'	30'	25'	20'	25'	20'	20'
Class I-IV Commodity						1454	1454	1454	1454	1454	1454	1454	1307	1193	1193
Cartoned Nonexpanded Plastic						1454	1454	1454	1454	1454	1454	1454	1307	1193	1193
Cartoned Expanded Plastic													1307	1193	1193
Exposed Nonexpanded Plastic						1454	1454	1454	1454	1454	1454	1454	1307	1193	1193

\*Standard length is 36-1/2". Also available in lengths of 18-1/2", 24-1/2", and 30-1/2". Refer to Viking's List Price Book for ordering information.

<sup>1</sup> Required flow per sprinkler calculated using  $Q=K^*(\sqrt{p})$  multiplied by number of design sprinklers (12)

22.4 (320) K-factor



VK506, ESFR Pendent

Base Part Number:	18493
Technical Datasheet:	F_081612
NPT Thread:	1 in

- Protects up to 40 ft (12,2m ) high piled storage without using in-rack sprinklers with ceilings up to 45 ft (13,7 m)
- May reduce or eliminate the need for a fire pump
- Available in 165° F and 205° F temperature ratings

NFPA 13 - Required Minimum Flow (GPM) - Single-Row, Double-Row, and Multi-Row Rack Storage (without solid shelves) <sup>1</sup>															
ceiling height (ft) >	45'					40'				35'			30'	25'	
storage height (ft) >	40'	35'	30'	25'	20'	35'	30'	25'	20'	30'	25'	20'	25'	20'	
Class I-IV Commodity	1701	1701	1701	1701	1701	1701	1701	1701	1701	1591	1591	1591	1344	1344	1344
Cartoned Nonexpanded Plastic	1701	1701	1701	1701	1701		1701	1701	1701	1591	1591	1591	1344	1344	1344
Exposed Nonexpanded Plastic						1901	1901	1901	1701	1591	1591	1591	1344	1344	1344

<sup>1</sup> Required flow per sprinkler calculated using  $Q=K^*(\sqrt{p})$  multiplied by number of design sprinklers (12)

25.2 (363) K-factor



VK510, ESFR Pendent

Base Part Number:	12080
Technical Datasheet:	F_100102
NPT Thread:	1 in

- Protects up to 45 ft (13,7 m) high buildings without using in-rack sprinklers
- May reduce or eliminate the need for a fire pump
- cULus Listed with deflector installed 6-18 in (102-330 mm) below ceiling for Ceiling heights up to 40 feet (6-14 in down for up to 45 ft ceiling heights)
- Available in 165°F and 205°F temperature ratings

NFPA 13 - Required Minimum Flow (GPM) - Single-Row, Double-Row, and Multi-Row Rack Storage (without solid shelves) <sup>1</sup>															
ceiling height (ft) >	45'					40'				35'			30'	25'	
storage height (ft) >	40'	35'	30'	25'	20'	35'	30'	25'	20'	30'	25'	20'	25'	20'	
Class I-IV Commodity	1913	1913	1913	1913	1913	1512	1512	1512	1512	1352	1352	1352	1171	1171	1171
Cartoned Nonexpanded Plastic	1913	1913	1913	1913	1913	1512	1512	1512	1512	1352	1352	1352	1171	1171	1171
Exposed Nonexpanded Plastic						2139	2139	2139							

<sup>1</sup> Required flow per sprinkler calculated using  $Q=K^*(\sqrt{p})$  multiplied by number of design sprinklers (12)

Storage Sprinkler U.S. Quick Reference Guide

ESFR Sprinklers continued from Page 11

## Early Suppression Fast Response (ESFR) Sprinklers

Viking ESFR sprinklers with K-factor of 16.8 and greater successfully meet the new UL 1767 test standard and compliance program for high clearance storage arrangements.

### 28.0 (404) K-factor



#### VK514, ESFR Pendent

Base Part Number:	19591
Technical Datasheet:	F_010715
NPT Thread:	1 in

- Protects up to 43 ft (13,1 m) high piled storage without using in-rack sprinklers in buildings with 48 ft (14,6 m) high ceilings
- UL Listed for aisle width as narrow as 6 ft (1,8 m)
- Available in 165° F and 205° F temperature ranges
- May reduce or eliminate the need for a fire pump

NFPA 13 - Required Minimum Flow (GPM) - Single-Row and Double-Row Rack Storage (without solid shelves)<sup>1</sup>

ceiling height (ft) >	48'						45'					40'				35'			30'		25'	
storage height (ft) >	43'	40'	35'	30'	25'	20'	40'	35'	30'	25'	20'	35'	30'	25'	20'	30'	25'	20'	25'	20'	20'	
Class I-IV Commodity	1992	1992	1992	1992	1992	1992	1992	1992	1992	1992	1992	1992	1992	1992	1992	1992	1992	1992	1992	1992	1992	1992
Cartoned Nonexpanded Plastic	1992	1992	1992	1992	1992	1992	1992	1992	1992	1992	1992	1992	1992	1992	1992	1992	1992	1992	1992	1992	1992	1992

<sup>1</sup> Required flow per sprinkler calculated using  $Q=K(\sqrt{p})$  multiplied by number of design sprinklers (12)

## Control Mode Specific Application (CMSA) Sprinklers

### 11.2 (161) K-factor



#### VK540, Large Drop, CMSA Upright

Base Part Number:	13167
Technical Datasheet:	F_090595
Response Type:	Standard
NPT Thread:	3/4 in

- Available in 155° F, 200°F, and 286°F temperature ratings
- Provides protection from severe challenge fires by creating larger water drops that penetrate the fire plume and cool the storage commodity
- Approved for storage of class I-IV commodities, heavyweight rolled paper, and expanded and nonexpanded plastics (cartoned and exposed)
- VK540 is approved for wet, dry, and preaction systems
- Eliminates the need for in-rack sprinklers in certain storage scenarios

NFPA 13 - Required Minimum Flow (GPM) - Single-Row, Double-Row, and Multi-Row Rack Storage (without solid shelves)<sup>1</sup>

ceiling height (ft) >	45'				40'				35'		30'		25'
storage height (ft) >	40'	35'	30'	25'	20'	35'	30'	25'	20'	30'	25'	20'	20'
Class I-II Commodity						2990 <sup>2</sup>				1120	840		1120 840
Class III Commodity										840			840 840
Class IV Commodity										1455			1188 1455 1188
Cartoned Nonexpanded Plastic										1940			1188 1940 1188
Exposed Plastic										1940			1188 1940 1188

<sup>1</sup> Required flow per sprinkler calculated using  $Q=K(\sqrt{p})$  multiplied by number of design sprinklers (Refer to NFPA 13)

<sup>2</sup> Requires one row of in-rack sprinklers

<sup>3</sup> Dry systems only

<sup>4</sup> Flows based upon wet systems.

### 19.6 (283) K-factor



#### VK592, CMSA Pendent

Base Part Number:	14243A
Technical Datasheet:	F_033108
Response Type:	Standard
NPT Thread:	1 in

- Available in 160°F and 205°F temperature ratings
- Protects up to 40 ft (12,2 m) high buildings without using in-rack sprinklers
- Requires lower overall water usage than ESFRs and other CMSA products
- Overcomes many obstruction challenges that impact ESFR sprinklers
- 12 ft (3,7 m) spacing between sprinklers provides enhanced design flexibility
- Listed and Approved for warehouses with aisles as narrow as 4 ft (1,2 m)
- UL Listed for concrete tee construction (prohibited for ESFR sprinklers)

NFPA 13 - Required Minimum Flow (GPM) - Single-Row, Double-Row, and Multi-Row Rack Storage (without solid shelves)<sup>1</sup>

ceiling height (ft) >	45'					40'				35'			30'		25'
storage height (ft) >	40'	35'	30'	25'	20'	35'	30'	25'	20'	30'	25'	20'	25'	20'	20'
Class I-IV Commodity						1610	1610	1610	1610	1470	1470	1470	1176	1176	1176
Cartoned Nonexpanded Plastic						1610	1610	1610	1610	1470	1470	1470	1176	1176	1176

<sup>1</sup> Unless otherwise indicated, the above data is based on FM approval guidelines

<sup>2</sup> Required flow per sprinkler calculated using  $Q=K(\sqrt{p})$  multiplied by number of design sprinklers (see data page)

<sup>3</sup> 40 ft ceiling height is UL listed only. FM approved for up to 35 ft ceiling height (30 ft of storage)

<sup>4</sup> Based on UL listed design criteria. VK592 is not FM approved at 40' ceiling heights.

Storage Sprinkler U.S. Quick Reference Guide

Control Mode Density Area (CMDA) Sprinklers

11.2 (161) K-factor



**VK530, Standard Response ELO Upright**

Base Part Number:	09679
Technical Datasheet:	F_010692
Response:	Standard
Element:	Glass Bulb
NPT Thread:	3/4 in

Example Density	Std CMDA Spk Spacing	(Q) Flow Rate / Sprinkler	(P) Starting Pressure	Example Water Demand (2,000 ft <sup>2</sup> design area)
0.3 gpm/ft <sup>2</sup>	100 ft <sup>2</sup>	30 gpm	7.2 psi	600 gpm
0.4 gpm/ft <sup>2</sup>	100 ft <sup>2</sup>	40 gpm	12.8 psi	800 gpm
0.5 gpm/ft <sup>2</sup>	100 ft <sup>2</sup>	50 gpm	19.9 psi	1,000 gpm
0.6 gpm/ft <sup>2</sup>	100 ft <sup>2</sup>	60 gpm	28.7 psi	1,200 gpm
0.7 gpm/ft <sup>2</sup>	100 ft <sup>2</sup>	70 gpm	39.1 psi	1,400 gpm
0.8 gpm/ft <sup>2</sup>	100 ft <sup>2</sup>	80 gpm	51.0 psi	1,600 gpm

11.2 (161) K-factor



**VK531, Quick Response ELO Upright**

Base Part Number:	10633
Technical Datasheet:	F_120699
Response:	Quick
Element:	Glass Bulb <sup>1</sup>
NPT Thread:	3/4 in

<sup>1</sup>Also available with fusible link (VK533-p/n 13978)  
- UL Listed ONLY

Example Density	Std CMDA Spk Spacing	(Q) Flow Rate / Sprinkler	(P) Starting Pressure	Example Water Demand (2,000 ft <sup>2</sup> design area)
0.3 gpm/ft <sup>2</sup>	100 ft <sup>2</sup>	30 gpm	7.2 psi	600 gpm
0.4 gpm/ft <sup>2</sup>	100 ft <sup>2</sup>	40 gpm	12.8 psi	800 gpm
0.5 gpm/ft <sup>2</sup>	100 ft <sup>2</sup>	50 gpm	19.9 psi	1,000 gpm
0.6 gpm/ft <sup>2</sup>	100 ft <sup>2</sup>	60 gpm	28.7 psi	1,200 gpm
0.7 gpm/ft <sup>2</sup>	100 ft <sup>2</sup>	70 gpm	39.1 psi	1,400 gpm
0.8 gpm/ft <sup>2</sup>	100 ft <sup>2</sup>	80 gpm	51.0 psi	1,600 gpm

11.2 (161) K-factor



**VK536, Standard Response ELO Pendant**

Base Part Number:	07961
Technical Datasheet:	F_072213
Response:	Standard
Element:	Glass Bulb
NPT Thread:	3/4 in

Example Density	Std CMDA Spk Spacing	(Q) Flow Rate / Sprinkler	(P) Starting Pressure	Example Water Demand (2,000 ft <sup>2</sup> design area)
0.3 gpm/ft <sup>2</sup>	100 ft <sup>2</sup>	30 gpm	7.2 psi	600 gpm
0.4 gpm/ft <sup>2</sup>	100 ft <sup>2</sup>	40 gpm	12.8 psi	800 gpm
0.5 gpm/ft <sup>2</sup>	100 ft <sup>2</sup>	50 gpm	19.9 psi	1,000 gpm
0.6 gpm/ft <sup>2</sup>	100 ft <sup>2</sup>	60 gpm	28.7 psi	1,200 gpm
0.7 gpm/ft <sup>2</sup>	100 ft <sup>2</sup>	70 gpm	39.1 psi	1,400 gpm
0.8 gpm/ft <sup>2</sup>	100 ft <sup>2</sup>	80 gpm	51.0 psi	1,600 gpm

11.2 (161) K-factor



**VK377, Quick Response ELO Pendant**

Base Part Number:	08337
Technical Datasheet:	F_030993
Response:	Quick
Element:	Glass Bulb
NPT Thread:	3/4 in

Example Density	Std CMDA Spk Spacing	(Q) Flow Rate / Sprinkler	(P) Starting Pressure	Example Water Demand (2,000 ft <sup>2</sup> design area)
0.3 gpm/ft <sup>2</sup>	100 ft <sup>2</sup>	30 gpm	7.2 psi	600 gpm
0.4 gpm/ft <sup>2</sup>	100 ft <sup>2</sup>	40 gpm	12.8 psi	800 gpm
0.5 gpm/ft <sup>2</sup>	100 ft <sup>2</sup>	50 gpm	19.9 psi	1,000 gpm
0.6 gpm/ft <sup>2</sup>	100 ft <sup>2</sup>	60 gpm	28.7 psi	1,200 gpm
0.7 gpm/ft <sup>2</sup>	100 ft <sup>2</sup>	70 gpm	39.1 psi	1,400 gpm
0.8 gpm/ft <sup>2</sup>	100 ft <sup>2</sup>	80 gpm	51.0 psi	1,600 gpm

Control Mode Density Area (CMDA) Sprinklers

16.8 (242) K-factor



**VK580, Standard Response CMDA Upright**

Base Part Number:	12739A
Technical Datasheet:	F_041904
Response:	Standard
Element:	Glass Bulb
NPT Thread:	3/4 in

Example Density	Std CMDA Spk Spacing	(Q) Flow Rate / Sprinkler	(P) Starting Pressure	Example Water Demand (2,000 ft <sup>2</sup> design area)
0.45 gpm/ft <sup>2</sup>	100 ft <sup>2</sup>	45 gpm	7.2 psi	900 gpm
0.5 gpm/ft <sup>2</sup>	100 ft <sup>2</sup>	50 gpm	8.9 psi	1,000 gpm
0.6 gpm/ft <sup>2</sup>	100 ft <sup>2</sup>	60 gpm	12.8 psi	1,200 gpm
0.7 gpm/ft <sup>2</sup>	100 ft <sup>2</sup>	70 gpm	17.4 psi	1,400 gpm
0.8 gpm/ft <sup>2</sup>	100 ft <sup>2</sup>	80 gpm	22.7 psi	1,600 gpm

25.2 (363) K-factor



**VK598, Standard Response CMDA Upright**

Base Part Number:	19522A
Technical Datasheet:	F_090414
Response:	Standard
Element:	Glass Bulb
NPT Thread:	1 in

- FM Approved Only - Design and install per FM Global Loss Prevention Data Sheet 8-9 (July 2015) only
- FM Approved for use in dry or preaction systems to protect Class I-III commodities with storage heights of up to 40 ft (12,2 m) in warehouses as high as 45 ft (13,7 m), without the need for additional in-rack sprinkler protection
- VK598 design criteria requires specific water delivery times, as indicated on the product's technical data sheet. Viking's Technical Services team will assist customers with performing the required fluid delivery calculations
- In FM storage designs, the VK598 can be used to protect any commodity hazard that can be protected by the K11.2 (K160) upright CMSA sprinkler, Model VK540- refer to Viking technical data for required pressures when using VK598

FM Global Loss Prevention Data Sheet 8-9 (July 2015) - Required Minimum Flow (GPM) - Open Frame Rack Storage (without need for in-rack sprinklers)															
ceiling height (ft) >	45'					40'				35'		30'		25'	
storage height (ft) >	40'	35'	30'	25'	20'	35'	30'	25'	20'	30'	25'	20'	25'	20'	
<b>Dry/Preaction</b>															
Class I-III Commodity	2140	2140	2140	2140	2140	2342	2342	2342	2342	2342	2342	2342	1992	1992	1333
<b>Wet System</b>															
Class I-IV Commodity													1352	1352	1352

**Storage Sprinkler U.S. Quick Reference Guide**

**Intermediate Level Sprinklers (In-Rack)**

**Preassembled with Water Shield**

5.6 (81) K-factor

**VK550  
SR Upright**



Base Part Number:	12986—U
Technical Datasheet:	F_012498
Response:	Standard
NPT Thread:	1/2 in
Finish:	Std. Brass

- Also available with fusible link (VK552-p/n 05557—U)
- Shield protects sprinkler from water discharge above
- Use where sprinkler guards are not required

**Preassembled with Water Shield**

8.0 (115) K-factor

**VK560  
SR Upright**



Base Part Number:	10141—U
Technical Datasheet:	F_012498
Response:	Standard
NPT Thread:	3/4 in
Finish:	Std. Brass

- Also available with fusible link (VK562-p/n 05514—U)
- Shield protects sprinkler from water discharge above
- Use where sprinkler guards are not required

**Preassembled with Water Shield**

5.6 (81) K-factor

**VK556  
QR Upright**



Base Part Number:	12978—U
Technical Datasheet:	F_012498
Response:	Quick
NPT Thread:	1/2 in
Finish:	Std. Brass

- Also available with fusible link (VK551-p/n 12279—U)
- Shield protects sprinkler from water discharge above
- Use where sprinkler guards are not required

**Preassembled with Water Shield**

8.0 (115) K-factor

**VK566  
QR Upright**



Base Part Number:	06665B—U
Technical Datasheet:	F_012498
Response:	Quick
NPT Thread:	3/4 in
Finish:	Std. Brass

- Shield protects sprinkler from water discharge above
- Also available with fusible link (VK567-p/n 13976—U)
- Use where sprinkler guards are not required

**Preassembled with Sprinkler Guard**

5.6 (81) K-factor

**VK100  
SR Upright**



Base Part Number:	12986—G
Technical Datasheet:	F_052014
Response:	Standard
NPT Thread:	1/2 in
Finish:	Std. Brass

- Also available with fusible link (VK108-p/n 12973—G)
- Preassembled guard protects sprinkler from damage

**Preassembled with Sprinkler Guard**

8.0 (115) K-factor

**VK200  
SR Upright**



Base Part Number:	10141—G
Technical Datasheet:	F_032814
Response:	Standard
NPT Thread:	3/4 in
Finish:	Std. Brass

- Also available with fusible link (VK204-p/n 05514—G)
- Preassembled guard protects sprinkler from damage

**Preassembled with Sprinkler Guard**

5.6 (81) K-factor

**VK102  
SR Pendent**



Base Part Number:	12987—G
Technical Datasheet:	F_031414
Response:	Standard
NPT Thread:	1/2 in
Finish:	Std. Brass

- Also available with fusible link (VK110-p/n 12972—G)
- Preassembled guard protects sprinkler from damage

**Preassembled with Sprinkler Guard**

8.0 (115) K-factor

**VK202  
SR Pendent**



Base Part Number:	10142—G
Technical Datasheet:	F-032614
Response:	Standard
NPT Thread:	3/4 in
Finish:	Std. Brass

- Also available with fusible link (VK206-p/n 05516—G)
- Preassembled guard protects sprinkler from damage

**Preassembled with Sprinkler Guard**

5.6 (81) K-factor

**VK300  
QR Upright**



Base Part Number:	12978—G
Technical Datasheet:	F_052114
Response:	Quick
NPT Thread:	1/2 in
Finish:	Std. Brass

- Also available in high pressure (250 PSI)-VK315
- Also available with fusible link (VK301-p/n 17535—G)
- Preassembled guard protects sprinkler from damage

**Preassembled with Sprinkler Guard**

8.0 (115) K-factor

**VK350  
QR Upright**



Base Part Number:	06665B—G
Technical Datasheet:	F_033014
Response:	Quick
NPT Thread:	3/4 in
Finish:	Std. Brass

- Preassembled guard protects sprinkler from damage

**Preassembled with Sprinkler Guard**

5.6 (81) K-factor

**VK302  
QR Pendent**



Base Part Number:	12979—G
Technical Datasheet:	F_033314
Response:	Quick
NPT Thread:	1/2 in
Finish:	Std. Brass

- Also available in high pressure (250 PSI)-VK317
- Also available with fusible link (VK303-p/n 17536—G)
- Preassembled guard protects sprinkler from damage

**Preassembled with Sprinkler Guard**

8.0 (115) K-factor

**VK352  
QR Pendent**



Base Part Number:	06666B—G
Technical Datasheet:	F_033414
Response:	Quick
NPT Thread:	3/4 in
Finish:	Std. Brass

- Preassembled guard protects sprinkler from damage

**Optional Water Shields**

**Model E-1 (upright)**



Shield



Field-installed

Part Number:	10326
Size:	1/2 in & 3/4 in

**Model F-1 (pendent)**



Shield



Field-installed

Part Number:	10323 1/2"
Part Number:	10324 3/4"
Size:	1/2 in & 3/4 in

For intermediate level sprinklers preassembled with guard, the Model F-1 water shield may be ordered separately, and field installed (not available preassembled).

Storage Sprinkler U.S. Quick Reference Guide

ELO Dry Pendant (FM Approved Standard Spray Storage Sprinklers)

11.2 (161.3) K-factor



**VK544, Standard Response Dry Pendant ELO**

Base Part Number:	19830
Technical Datasheet:	F_040815
Response:	Standard
Element:	Fusible Link
NPT Thread:	1-1/4 in

Example Density	Std CMDA Spk Spacing	(Q) Flow Rate / Sprinkler	(P) Starting Pressure	Example Water Demand (2,000 ft <sup>2</sup> design area)
0.3 gpm/ft <sup>2</sup>	100 ft <sup>2</sup>	30 gpm	7.2 psi	600 gpm
0.4 gpm/ft <sup>2</sup>	100 ft <sup>2</sup>	40 gpm	12.8 psi	800 gpm
0.5 gpm/ft <sup>2</sup>	100 ft <sup>2</sup>	50 gpm	19.9 psi	1,000 gpm
0.6 gpm/ft <sup>2</sup>	100 ft <sup>2</sup>	60 gpm	28.7 psi	1,200 gpm
0.7 gpm/ft <sup>2</sup>	100 ft <sup>2</sup>	70 gpm	39.1 psi	1,400 gpm
0.8 gpm/ft <sup>2</sup>	100 ft <sup>2</sup>	80 gpm	51.0 psi	1,600 gpm

11.2 (161.3) K-factor



**VK547, Quick Response Dry Pendant ELO**

Base Part Number:	19828
Technical Datasheet:	F_040915
Response:	Quick
Element:	Fusible Link
NPT Thread:	1-1/4 in

Example Density	Std CMDA Spk Spacing	(Q) Flow Rate / Sprinkler	(P) Starting Pressure	Example Water Demand (2,000 ft <sup>2</sup> design area)
0.3 gpm/ft <sup>2</sup>	100 ft <sup>2</sup>	30 gpm	7.2 psi	600 gpm
0.4 gpm/ft <sup>2</sup>	100 ft <sup>2</sup>	40 gpm	12.8 psi	800 gpm
0.5 gpm/ft <sup>2</sup>	100 ft <sup>2</sup>	50 gpm	19.9 psi	1,000 gpm
0.6 gpm/ft <sup>2</sup>	100 ft <sup>2</sup>	60 gpm	28.7 psi	1,200 gpm
0.7 gpm/ft <sup>2</sup>	100 ft <sup>2</sup>	70 gpm	39.1 psi	1,400 gpm
0.8 gpm/ft <sup>2</sup>	100 ft <sup>2</sup>	80 gpm	51.0 psi	1,600 gpm

Note: Two optional insulating boots (19330M/W) provided with every plain barrel style sprinkler; one boot shipped with each standard adjustable and recessed adjustable model. Installation of the provided boot assembly is optional.

Extended Coverage Storage Sprinkler

25.2 (363) K-factor



**VK595, EC Upright (CMDA and CMSA Applications)**

Base Part Number:	16859A
Technical Datasheet:	F_121610
Response:	Quick/Standard
Element:	Fusible Link
NPT Thread:	1 in

Example Density	Sprinkler Spacing	(Q) Flow Rate / Sprinkler	(P) Starting Pressure	Example Water Demand (2,000 ft <sup>2</sup> design area)
0.3 gpm/ft <sup>2</sup>	196 ft <sup>2</sup>	66.7 gpm	7.0 psi	734 gpm
0.4 gpm/ft <sup>2</sup>	196 ft <sup>2</sup>	78.4 gpm	9.7 psi	863 gpm
0.5 gpm/ft <sup>2</sup>	196 ft <sup>2</sup>	98.0 gpm	15.1 psi	1,078 gpm
0.6 gpm/ft <sup>2</sup>	196 ft <sup>2</sup>	117.6 gpm	21.8 psi	1,294 gpm
0.7 gpm/ft <sup>2</sup>	100 ft <sup>2</sup>	70.0 gpm	7.7 psi	1,400 gpm
0.7 gpm/ft <sup>2</sup>	196 ft <sup>2</sup>	137.2 gpm	29.6 psi	1,509 gpm
0.8 gpm/ft <sup>2</sup>	100 ft <sup>2</sup>	80.0 gpm	10.1 psi	1,600 gpm
0.8 gpm/ft <sup>2</sup>	196 ft <sup>2</sup>	156.8 gpm	38.7 psi	1,725 gpm

- 14 ft x 14 ft maximum coverage area (4.3 m x 4.3 m)
- Suitable for “unobstructed” and certain “non-combustible obstructed” construction
- FM Approved as a quick response, extended coverage sprinkler for both storage and non-storage applications (refer to FM Loss Prevention datasheets and Viking technical datasheet page 124j-m for FM design and installation details)
- Available in 165° F and 214° F temperature ratings

General Inquiries and Technical Services

<p><u>General Inquiries</u>                  P: (65) 62784061                  F: (65) 62784609                  jong@vikingcorp.com</p>	<p><u>Technical Services</u>                  P: (65) 62784061                  F: (65) 62784609                  lweeming@vikingcorp.com</p>
--	---

# Dry Sprinkler

## Quick Reference Guide

This guide is intended for general reference only. Prior to the design, layout, and/or installation of any sprinkler system, please refer to Viking's technical documentation and always consult with the AHJ. Viking makes no representation or warranty as to whether following this guide will satisfy any rule or requirement. Please visit [www.vikinggroupinc.com](http://www.vikinggroupinc.com) for the most current technical data and product specifications. All products must be installed in accordance with the manufacturer's current installation instructions. Viking reserves the right to change product specifications at any time without notice and without incurring obligation.



### Light Hazard (Only)

VK186-Recessed Pendant Part# 10541U(f,t,l)	VK196-Concealed Pendant <sup>1</sup> Part# 12423U(f,t,l)	VK188-Recessed Horiz Sidewall Part# 10542U(f,t,l)
		

\* See back panel for ordering instructions (f=finish, t=temperature, l=length)  
<sup>1</sup> Domed cover plate ordered separately (p/n 12381)

#### Extended Coverage – Standard / Quick Response 5.6 (81) K Factor – Pendant, Domed Concealed Pendant, Horizontal Sidewall

- cULus listed
  - 1 inch NPT (25 mm BSP)
  - Finish (f): chrome, white-polyester, nickel PTFE; brass (VK196 only)
  - VK196 cover plates available in chrome, white, ivory, and black
  - Temperature (t): 155°F (68°C), 175°F (79°C)—VK196 is also available in 135°F (57°C)
  - Length (l): Order in 1/4" increments.
- See technical datasheets 108a-f, 108j-o, and 109a-f for design and installation data.

VK152-Plain Barrel Part# 07858U(f,t,l)	VK156-Standard Adjustable Part# 07857U(f,t,l)	VK162-Recessed Adjustable Part# 07856U(f,t,l)
		

\* See back panel for ordering instructions (f=finish, t=temperature, l=length)

#### Standard Coverage – Standard Response 5.6 (81) K Factor – Horizontal Sidewall

- cULus listed and FM approved
  - 1 inch NPT (25 mm BSP)
  - Finish (f): chrome, white-polyester, nickel PTFE; brass (VK152 only)
  - Temperature (t): 155°F (68°C), 175°F (79°C), 200°F (93°C), 286°F (141°C)—VK162 NOT available in 286°F (141°C)
  - Length (l): Order in 1/2" increments for VK156 & VK152. VK162 available in 1/4" increments.
- See technical datasheet 102a-i for complete design and installation specifications.

VK174-Plain Barrel Part# 08388U(f,t,l)	VK178-Standard Adjustable Part# 08384U(f,t,l)	VK182-Recessed Adjustable Part# 08386U(f,t,l)
		

\* See back panel for ordering instructions (f=finish, t=temperature, l=length)

#### Standard Coverage – Quick Response 5.6 (81) K Factor – Horizontal Sidewall

- cULus listed
  - 1 inch NPT (25 mm BSP)
  - Finish (f): chrome, white-polyester; brass (VK174 only)
  - Temperature (t): 155°F (68°C), 175°F (79°C), 200°F (93°C), 286°F (141°C)—VK182 NOT available in 286°F (141°C)
  - Length (l): Order in 1/2" increments for VK174 & VK178. VK182 available in 1/4" increments.
- See technical datasheet 106a-h for complete design and installation specifications.

VK153-Plain Barrel Part# 09125U(f,t,l)	VK157-Standard Adjustable Part# 09123U(f,t,l)	VK161-Recessed Adjustable Part# 09124U(f,t,l)
		

\* See back panel for ordering instructions (f=finish, t=temperature, l=length)

#### Standard Coverage – Standard Response 5.6 (81) K Factor – Vertical Sidewall

- These products are NOT listed or approved.
  - 1 inch NPT (25 mm BSP)
  - Finish (f): chrome, white-polyester; brass (VK153 only)
  - Temperature (t): 155°F (68°C), 175°F (79°C), 200°F (93°C), 286°F (141°C)—VK161 NOT available in 286°F (141°C)
  - Length (l): Order in 1/2" increments for VK153 & VK157. VK161 available in 1/4" increments.
- See technical datasheet 103a-f for complete design and installation specifications.



Light and Ordinary Hazard

VK184-Plain Barrel  
Part#08417U(f,t,l)



\* See back panel for ordering instructions (f=finish, t=temperature, l=length)

Standard Coverage – Quick Response  
5.6 (81) K Factor – Upright

- cULus listed
  - 1 inch NPT (25 mm BSP)
  - Finish (f): white-polyester, brass
  - Temperature (t): 155°F (68°C), 175°F (79°C), 200°F (93°C), 286°F (141°C)
  - Length (l): Order in 1/2" increments.
  - Standard length is 4-1/2 to 48-1/2 in.
- See technical datasheet 107a-e for complete design and installation data.

VK172-Plain Barrel  
Part#08387U(f,t,l)



VK176-Standard Adjustable  
Part#08383U(f,t,l)



VK180-Recessed Adjustable  
Part#08385U(f,t,l)



\* See back panel for ordering instructions (f=finish, t=temperature, l=length)

Standard Coverage – Quick Response  
5.6 (81) K Factor – Pendent

- cULus listed
  - 1 inch NPT (25 mm BSP)
  - Finish (f): chrome, white-polyester; brass (VK172 only)
  - Temperature (t): 155°F (68°C), 175°F (79°C), 200°F (93°C), 286°F (141°C)—VK180 NOT available in 286°F (141°C)
  - Length (l): Order in 1/2" increments for VK172 & VK176. VK180 available in 1/4" increments.
- See technical datasheet 105a-f for complete design and installation specifications.

VK482-Recessed Flush Style  
Part#18385(f,t,l)



VK194-Concealed  
Part#12422U(f,t,l)



Domed Cover Plate  
Part#12381U(f,t,l)  
(order separately)



\* See back panel for ordering instructions (f=finish, t=temperature, l=length)

Standard Coverage – Quick Response  
5.6 (81) K Factor – Recessed Flush and Domed Concealed Pendants

- cULus Listed
  - 1 inch NPT (25 mm BSP)
  - VK482 Available Finishes: white
  - VK194 Cover Plate Finishes: white, chrome, ivory, black
  - VK482 Temperature Ratings: 165°F (74°C), 205°F (96°C)
  - VK194 Temperature Ratings: 155°F (68°C), 175°F (79°C), 200°F (93°C)
  - Length (l): Order in 1/4 inch increments (standard length is 4" to 48-1/4" for VK194 and 4-1/2" to 48" for VK482).
- See technical datasheets 111a-g (VK482) and 104j-n (VK194) for complete specifications.

VK173-Plain Barrel  
Part#13248(f,t,l)



VK177-Standard Adjustable  
Part#13249(f,t,l)



VK181-Recessed Adjustable  
Part#13250(f,t,l)



\* See back panel for ordering instructions (f=finish, t=temperature, l=length)

Standard Coverage – Quick Response  
8.0 (115) K Factor – Pendent

- cULus listed
  - 1 inch NPT (25 mm BSP)
  - Finish (f): chrome, white-polyester; brass (VK173 only)
  - Temperature (t): 155°F (68°C), 175°F (79°C), 200°F (93°C), 286°F (141°C)—VK181 NOT available in 286°F (141°C)
  - Length (l): Order in 1/2" increments for VK173 & VK177. VK181 available in 1/4" increments.
- See technical datasheet 105h-n for complete design and installation specifications.

VK282-Plain Barrel  
Part#13254(f,t,l)



VK286-Standard Adjustable  
Part#13255(f,t,l)



VK290-Recessed Adjustable  
Part#13256(f,t,l)



\* See back panel for ordering instructions (f=finish, t=temperature, l=length)

Standard Coverage – Quick Response  
8.0 (115) K Factor – Pendent (Fusible Link)

- cULus listed
  - 1 inch NPT (25 mm BSP)
  - Finish (f): chrome, white-polyester (VK286, VK290); chrome, brass (VK282)
  - Temperature (t): 165°F (74°C), 205°F (96°C), 280°F (138°C)—VK290 NOT available in 280°F (138°C)
  - Length (l): Order in 1/2" increments for VK282 & VK286. VK290 available in 1/4" increments.
- See technical datasheet 105p-u for complete design and installation specifications.

Light and Ordinary Hazard Sprinklers continued from page 17



\* See back panel for ordering instructions (f=finish, t=temperature, l=length)

**Standard Coverage – Standard Response**  
**8.0 (115) K Factor – Horizontal Sidewall**

- cULus listed
  - 1 inch NPT (25 mm BSP)
  - Finish (f): chrome, white-polyester, nickel PTFE; brass (VK250 only)
  - Temperature (t): 155°F (68°C), 175°F (79°C), 200°F (93°C), 286°F (141°C)—VK254 NOT available in 286°F (141°C)
  - Length (l): Order in 1/2" increments for VK250 & VK252. VK254 available in 1/4" increments.
- See technical datasheet 102j-q for complete design and installation data.



\* See back panel for ordering instructions (f=finish, t=temperature, l=length)

**Standard Coverage – Quick Response**  
**8.0 (115) K Factor – Horizontal Sidewall**

- cULus listed
  - 1 inch NPT (25 mm BSP)
  - Finish (f): chrome, white-polyester; brass (VK275 only), nickel PTFE (VK277 only)
  - Temperature (t): 155°F (68°C), 175°F (79°C), 200°F (93°C), 286°F (141°C)—VK279 NOT available in 286°F (141°C)
  - Length (l): Order in 1/2" increments for VK275 & VK277. VK279 available in 1/4" increments.
- See technical datasheet 1065-z for complete design and installation specifications.



\* See back panel for ordering instructions (f=finish, t=temperature, l=length)

**Standard Coverage – Quick Response**  
**8.0 (115) K Factor – Horizontal Sidewall (Fusible Link)**

- cULus listed
  - 1 inch NPT (25 mm BSP)
  - Finish (f): chrome, white-polyester (VK288, VK292); chrome, brass (VK284)
  - Temperature (t): 15°F (74°C), 205°F (96°C), 280°F (138°C)—VK292 is NOT available in 280°F (138°C)
  - Length (l): Order in 1/2" increments for VK284 & VK288. VK292 available in 1/4" increments.
- See technical datasheet 107h-o for complete design and installation specifications.

**Light, Ordinary, and Extra Hazard**



\* See back panel for ordering instructions (f=finish, t=temperature, l=length)

**Standard Coverage – Standard Response**  
**5.6 (81) K Factor – Upright**

- cULus listed and FM approved
  - 1 inch NPT (25 mm BSP)
  - Finish (f): white-polyester, brass
  - Temperature (t): 155°F (68°C), 175°F (79°C), 200°F (93°C), 286°F (141°C)
  - Length (l): Order in 1/2" increments.
  - Standard length is 4-1/2 to 48-1/2 in.
- See technical datasheet 101j-n for complete design and installation specifications.



\* See back panel for ordering instructions (f=finish, t=temperature, l=length)

**Standard Coverage – Standard Response**  
**5.6 (81) K Factor – Pendent**

- cULus listed and FM approved
  - 1 inch NPT (25 mm BSP)
  - Finish (f): chrome, white-polyester, nickel PTFE; brass (VK150 only)
  - Temperature (t): 155°F (68°C), 175°F (79°C), 200°F (93°C), 286°F (141°C)—VK158 NOT available in 286°F (141°C)
  - Length (l): Order in 1/2" increments for VK150 & VK154. VK158 available in 1/4" increments.
- See technical datasheet 101a-g for complete design and installation specifications.

Light, Ordinary Hazard, and Extra Hazard Sprinklers continued from page 18



\* See back panel for ordering instructions (f=finish, t=temperature, l=length)

**Standard Coverage – Standard Response  
8.0 (115) K Factor – Pendent**

- cULus listed
  - 1 inch NPT (25 mm BSP)
  - Finish (f): chrome, white-polyester, nickel PTFE; brass (VK163 only)
  - Temperature (t): 155°F (68°C), 175°F (79°C), 200°F (93°C), 286°F (141°C)—VK164 NOT available in 286°F (141°C)
  - Length (l): Order in 1/2" increments for VK166 & VK163. VK164 available in 1/4" increments.
- See technical datasheet 101o-t for complete design and installation data.



\* See back panel for ordering instructions (f=finish, t=temperature, l=length)

**Standard Coverage – Standard Response  
5.6 (81) and 8.0 (115) K Factor – Domed Concealed Pendent**

- cULus listed
  - 1 inch NPT (25 mm BSP)
  - Finish (f): brass (cover plates available in chrome, white, ivory, black)
  - Temperature (t): 155°F (68°C), 175°F (79°C), and 200°F (93°C)—cover plate available in 135°F (57°C) and 165°F (74°C)
  - Length (l): Order in 1/4" increments. Standard length is 4" to 48-1/4 in.
- See technical datasheets 104a-e and 104q-v for complete design and installation specifications.



\* See back panel for ordering instructions (f=finish, t=temperature, l=length)

**Standard Coverage – Standard Response  
5.6 (81) K Factor – Pendent (Stainless Steel)**

- These products are NOT listed or approved.
  - 1 inch NPT (25 mm BSP)
  - Finish (f): stainless steel
  - Temperature (t): 155°F (68°C), 175°F (79°C), 200°F (93°C), 286°F (141°C)—VK169 is NOT available in 286°F (141°C)
  - Length (l): Order in 1/2" increments for VK168 and 1/4" increments for VK169.
- See technical datasheet 101u-x for complete design and installation specifications.

Example [base(f)(t)(l)]  
VK150, Chrome, 155°F, 10" long

**07852UFB10**



To order add desired Finish (f), Temperature (t), and Length (l)  
Finish (f) and Temperature (t) codes are available in Viking's List Price Book.  
For Length (l) please see A or B Dimension diagrams below.

\* Dry sprinklers are customer specific products and are NOT RETURNABLE. Any changes made after order submission are subject to charges for manufacturing processes completed at the time of change or cancellation. These charges could be equal to the value of the original order. Please check the information carefully before ordering. Refer to Viking Technical Data for detailed product information.

Finish Suffixes (f)	
Brass	A
Chrome	F
White-Poly	M-/W
Temp Suffixes (t)	
135°F	A
155°F	B
165°F	C
175°F	D
200°F / 205°F	E
280°F / 286°F	G

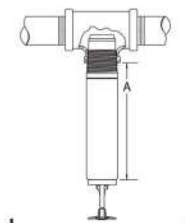

Plain Barrel Pendent and HSW

- For "A" Dimension:
1. Determine distance from face of the tee to the base of the sprinkler.
  2. Round up to next highest 1/2" (13 mm) increment between 3" (76 mm) and 47" (1194 mm).

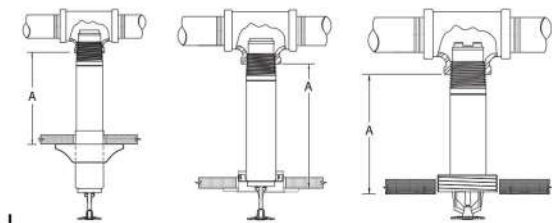

Standard Adjustable, Recessed Adjustable, Domed Concealed Pendent and HSW

- For "A" Dimension:
1. Determine the distance from the face of tee to the surface of finished ceiling or wall.
  2. - For Standard Adjustable round to the nearest 1/2" (13 mm) between 1-1/2" and 45-1/2" (38 mm and 1156 mm).  
- For Recessed Adjustable round to the nearest 1/4" (6 mm) between 3-1/4" and 47-1/2" (83 mm and 1207mm).  
- For Domed Concealed round to the nearest 1/4" (6 mm) between 4" and 48-1/4" (102 mm and 1226 mm).

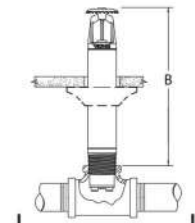

Plain Barrel Upright

- For "B" Dimension:
1. Determine the distance from the face of the tee to the top of the sprinkler deflector.
  2. Round to the nearest 1/2" (13 mm) increment between 4-1/2" and 48-1/2" (114 mm and 1232 mm).

## Residential Sprinkler Quick Reference Guide

This guide is intended for general reference only. Prior to the design, layout, and/or installation of any sprinkler system, please refer to Viking's technical documentation and always consult with the AHJ. Viking makes no representation or warranty as to whether following this guide will satisfy any rule or requirement. Please visit [www.vikinggroupinc.com](http://www.vikinggroupinc.com) for the most current technical data and product specifications. All products must be installed in accordance with the manufacturer's current installation instructions. Viking reserves the right to change product specifications at any time without notice and without incurring obligation.



### Pendent and Recessed Pendent Sprinklers

Recessed adjustment up to 5/8" (16 mm)

3.0 (43) K-factor



**VK470, Part No. 17147**  
**Technical datasheet F\_061011**

- Sprinkler temp = 155°F/68°C and 175°F/79°C
- Enables two-head design with flows less than 20 gpm (75,7 lpm)
- Can optimize NFPA 13 residential designs when combined with larger K-factor residential sprinklers
- Available with ENT plating (Nickel PTFE) for corrosion resistance

Coverage Area ft (m)	Horizontal Ceiling	
	Flow gpm (lpm)	Pressure psi (kPa)
12 x 12 (3,7x3,7)	8 (30)	7.1 (49)
14 x 14 (4,3x4,3)	10 (38)	11.1 (77)
16 x 16 (4,9x4,9)	13 (49)	18.8 (129)

4.3 (62) K-factor



**VK430, Part No. 09530**  
**Technical datasheet F\_082095**

- Sprinkler temp = 155°F/68°C and 175°F/79°C
- Continually listed by UL since 1995
- Available with ENT plating (Nickel PTFE) for corrosion resistance

12 x 12 (3,7x3,7)	12 (45)	7.8 (54)
14 x 14 (4,3x4,3)	13 (49)	9.1 (63)
16 x 16 (4,9x4,9)	13 (49)	9.1 (63)
18 x 18 (5,5x5,5)	17 (64)	15.6 (108)
20 x 20 (6,1x6,1)	21 (80)	23.9 (164)

4.9 (71) K-factor



**VK468, Part No. 13637**  
**Technical datasheet F\_012706**

- Sprinkler temp = 155°F/68°C and 175°F/79°C
- Available with ENT plating (Nickel PTFE) for corrosion resistance

12 x 12 (3,7x3,7)	13 (49)	7.0 (48)
14 x 14 (4,3x4,3)	13 (49)	7.0 (48)
16 x 16 (4,9x4,9)	13 (49)	7.0 (48)
18 x 18 (5,5x5,5)	17 (64)	12.0 (83)
20 x 20 (6,1x6,1)	20 (76)	16.7 (115)

5.2 (75) K-factor



**VK466, Part No. 13781**  
**Technical datasheet F\_019406**

- Sprinkler temp = 155°F/68°C and 175°F/79°C
- Available with ENT plating (Nickel PTFE) for corrosion resistance

12 x 12 (3,7x3,7)	14 (53)	7.2 (50)
14 x 14 (4,3x4,3)	14 (53)	7.2 (50)
16 x 16 (4,9x4,9)	14 (53)	7.2 (50)
18 x 18 (5,5x5,5)	17 (64)	10.7 (74)
20 x 20 (6,1x6,1)	20 (76)	14.8 (1.02)

5.8 (84) K-factor



**VK472, Part No. 16130**  
**Technical datasheet F\_121409**

- Sprinkler temp = 155°F/68°C and 175°F/79°C
- Larger K-factor provides lower starting pressure in NFPA 13 applications (0.1, gpm/ft<sup>2</sup> density)
- Available with ENT plating (Nickel PTFE) for corrosion resistance

12 x 12 (3,7x3,7)	16 (61)	7.6 (52)
14 x 14 (4,3x4,3)	16 (61)	7.6 (52)
16 x 16 (4,9x4,9)	16 (61)	7.6 (52)
18 x 18 (5,5x5,5)	17 (64)	8.6 (59)
20 x 20 (6,1x6,1)	21 (80)	13.1 (90)

7.4 (107) K-factor



**VK458, Part No. 13230**  
**Technical datasheet F\_042005**

- Sprinkler temp = 155°F/68°C and 175°F/79°C
- Larger K-factor provides lower starting pressure in NFPA 13 applications (0.1, gpm/ft<sup>2</sup> density)
- Available with ENT plating (Nickel PTFE) for corrosion resistance

12 x 12 (3,7x3,7)	20 (76)	7.3 (50)
14 x 14 (4,3x4,3)	20 (76)	7.3 (50)
16 x 16 (4,9x4,9)	20 (76)	7.3 (50)
18 x 18 (5,5x5,5)	23 (83)	8.8 (61)
20 x 20 (6,1x6,1)	24 (91)	10.5 (73)

\*Flows shown for 155°F/68°C; see technical datasheet for flows at 175°F/79°C.

All application data is for smooth, flat, horizontal ceilings unless otherwise noted, and is per each sprinkler's cULus Listing for systems designed to NFPA 13D or NFPA 13R requiring a 0.05 gpm/ft<sup>2</sup> density.

Residential Sprinkler Quick Reference Guide

### Flat Plate Concealed Pendent Sprinklers

Cover Plate Temp = 135°F/57°C; Adjustment up to 1/2" (13 mm)

3.0 (43) K-factor



**VK488, Part No. 18325AC**  
**Technical datasheet F\_073012**

- Sprinkler temp = 165°F/74°C and 205°F/96°C
- Enables two-head design with flows less than 20 gpm (76 lpm)
- Can optimize NFPA 13 residential designs when combined with larger K-factor residential sprinklers

Coverage Area ft (m)	Horizontal Ceiling	
	Flow gpm (lpm)	Pressure psi (kPa)
12 x 12 (3,7x3,7)	8 (30)	7.1 (49)
14 x 14 (4,3x4,3)	11 (42)	13.4 (92)
16 x 16 (6,1x6,1)	13 (49)	18.8 (130)

4.9 (71) K-factor



**VK457, Part No. 14694AC**  
**Technical datasheet F\_072607**

- Sprinkler temp = 165°F/74°C and 205°F/96°C (Listed flows and pressures for intermediate temp rating may be higher than ordinary temp - refer to technical datasheet)
- Available with either standard, large or square cover plate
- Available with ENT plating (Nickel PTFE) for corrosion resistance

12 x 12 (3,7x3,7)	13 (49)	7.0 (48)
14 x 14 (4,3x4,3)	13 (49)	7.0 (48)
16 x 16 (4,9x4,9)	13 (49)	7.0 (48)
18 x 18 (5,5x5,5)	17 (64)	12.0 (83)
20 x 20 (6,1x6,1)	20 (76)	16.7 (115)

4.9 (71) K-factor



**VK494, Part No. 20759**  
**Technical datasheet F\_012116**

- Sprinkler temp = 155°F/68°C, 175°F/79°C, and 200°F/93°C
- UL Listed flow rates are identical for all three temperature ratings
- Intermediate temperature models provide greater installation flexibility
- Available with either standard, large, or square cover plate
- Available with ENT plating (Nickel PTFE) for corrosion resistance

12 x 12 (3,7x3,7)	13 (49)	7.0 (48)
14 x 14 (4,3x4,3)	13 (49)	7.0 (48)
16 x 16 (4,9x4,9)	13 (49)	7.0 (48)
18 x 18 (5,5x5,5)	17 (64)	12.0 (83)
20 x 20 (6,1x6,1)	20 (76)	16.7 (115)

5.8 (84) K-factor



**VK474, Part No. 15790AC**  
**Technical datasheet F\_012109**

- Sprinkler temp = 165°F/74°C and 205°F/96°C
- Larger K-factor provides lower starting pressure in NFPA 13 applications (0.1 gpm/ft<sup>2</sup> density)
- Available with ENT plating (Nickel PTFE) for corrosion resistance

12 x 12 (3,7x3,7)	16 (61)	7.6 (52)
14 x 14 (4,3x4,3)	16 (61)	7.6 (52)
16 x 16 (4,9x4,9)	16 (61)	7.6 (52)
18 x 18 (5,5x5,5)	19 (72)	10.7 (74)
20 x 20 (6,1x6,1)	23 (87)	15.7 (110)

### Domed Concealed Pendent Sprinklers

Cover Plate Temp = 135°F /57°C; Adjustment up to 1/2" (13 mm)

4.9 (71) K-factor



**VK468-D, Part No. 13637A-X, 12207**  
**Technical datasheet F\_020206**

- Sprinkler temp = 155°F/68°C and 175°F/79°C
- Available with ENT plating (Nickel PTFE) for corrosion resistance

Coverage Area ft (m)	Horizontal Ceiling	
	Flow gpm (lpm)	Pressure psi (kPa)
12 x 12 (3,7x3,7)	13 (49)	7.0 (48)
14 x 14 (4,3x4,3)	13 (49)	7.0 (48)
16 x 16 (4,9x4,9)	13 (49)	7.0 (48)
18 x 18 (5,5x5,5)	17 (64)	12.0 (83)
20 x 20 (6,1x6,1)	20 (76)	16.7 (115)

5.2 (75) K-factor



**VK466-D, Part No. 13781A-X, 12207**  
**Technical datasheet F\_091606**

- Sprinkler temp = 155°F/68°C and 175°F/79°C
- Available with ENT plating (Nickel PTFE) for corrosion resistance

12 x 12 (3,7x3,7)	14 (53)	7.2 (50)
14 x 14 (4,3x4,3)	14 (53)	7.2 (50)
16 x 16 (4,9x4,9)	14 (53)	7.2 (50)
18 x 18 (5,5x5,5)	17 (64)	10.7 (74)
20 x 20 (6,1x6,1)	20 (76)	14.8 (102)

7.4 (107) K-factor



**VK458-D, Part No. 13230ABX, 12207**  
**Technical datasheet F\_092305**

- Sprinkler temp = 155°F/68°C
- Larger K-factor provides lower starting pressure in NFPA 13 applications (0.1 gpm/ft<sup>2</sup> density)
- Available with ENT plating (Nickel PTFE) for corrosion resistance

12 x 12 (3,7x3,7)	20 (76)	7.3 (50)
14 x 14 (4,3x4,3)	20 (76)	7.3 (50)
16 x 16 (4,9x4,9)	20 (76)	7.3 (50)
18 x 18 (5,5x5,5)	23 (87)	9.7 (67)
20 x 20 (6,1x6,1)	28 (106)	14.3 (99)

Viking offers lead-free versions of several Freedom® residential sprinklers. Please refer to Viking's technical datasheets for complete design and installation data.

(1) Lead content complies with the definition of 'Lead Free' established in the Reduction of Lead in Drinking Water Act (S.3874) endorsed by AWWA's Water Utility Council, and California Assembly Bill # 1953.

Residential Sprinkler Quick Reference Guide

### Flush Concealed Pendent Sprinklers

Adjustment up to 5/8" (16mm) with ceiling ring (Part No. 15618)

4.9 (71) K-factor



**VK476, Part No. 15630A**  
**Technical datasheet F\_120608**

- Sprinkler temp = 165°F/74°C
- Sprinkler and outer ring sold together

Coverage Area ft (m)	Horizontal Ceiling Flow gpm (lpm)	Pressure psi (kPa)
12 x 12 (3,7x3,7)	13 (49)	7.0 (48)
14 x 14 (4,3x4,3)	13 (49)	7.0 (48)
16 x 16 (4,9x4,9)	13 (49)	7.0 (48)
18 x 18 (5,5x5,5)	17 (64)	12.0 (83)
20 x 20 (6,1x6,1)	21 (80)	18.4 (127)

### Horizontal Sidewall Sprinklers

Available in 155°F/68°C and 175°F/79°C; Recessed adjustment up to 5/8" (16mm)

3.0 (43) K-factor



**VK479, Part No. 19707**  
**Technical datasheet F\_012915**

- Sprinkler temp = 155°F/68°C
- Patented "flow shaper" design provides the ultimate combination of low flows and starting pressures
- Can optimize NFPA 13 residential designs when combined with larger K-factor residential sprinklers
- Available with ENT plating (Nickel PTFE) for corrosion resistance

Coverage Area ft (m)	4-12" (102mm-305mm) From Ceiling	
	Flow gpm (lpm)	Pressure psi (kPa)
12 x 12 (3,7x3,7)	11 (42)	13.4 (92)
14 x 14 (4,3x4,3)	13 (49)	18.8 (129)
16 x 16 (4,9x4,9)	13 (49)	18.8 (129)

4.0 (58) K-factor



**VK486, Part No. 17315**  
**Technical datasheet F\_482011**

- Sprinkler temp = 155°F/68°C and 175°F/79°C
- Patented "flow shaper" design provides the ultimate combination of low flows and starting pressures
- Lowest flow rate in the industry
- Available with ENT plating (Nickel PTFE) for corrosion resistance

Coverage Area ft (m)	4-6" (102mm-152mm) From Ceiling		6-12" (152mm-305mm) From Ceiling	
	Flow gpm (lpm)	Pressure psi (kPa)	Flow gpm (lpm)	Pressure psi (kPa)
12 x 12 (3,7x3,7)	11 (42)	7.6 (52)	12 (46)	9.0 (62)
14 x 14 (4,3x4,3)	12 (46)	9.0 (62)	12 (46)	9.0 (62)
16 x 16 (4,9x4,9)	13 (49)	10.6 (73)	14 (53)	12.3 (85)
16 x 18 (4,9x5,5)	16 (61)	16.0 (110)	16 (61)	16 (110)
16 x 20 (4,9x6,1)	22 (83)	30.3 (209)	23 (87)	33.1 (228)
16 x 22 (4,9x6,7)	24 (91)	36.0 (248)	26 (98)	42.3 (291)
18 x 18 (5,5x5,5)	18 (68)	20.3 (140)	18 (68)	20.3 (140)
18 x 20 (5,5x6,1)	22 (83)	30.3 (209)	23 (87)	33.1 (228)
20 x 20 (6,1x6,1)	22 (83)	30.3 (209)	24 (91)	36.0 (248)

\*Flows shown for 155°F/68°C; see technical datasheet for flows at 175°F/79°C.

4.2 (60) K-factor



**VK484, Part No. 16240**  
**Technical datasheet F\_090310**

- Sprinkler temp = 155°F/68°C and 175°F/79°C
- Available with ENT plating (Nickel PTFE) for corrosion resistance

12 x 12 (3,7x3,7)	13 (49)	9.6 (66)	14 (53)	11.1 (77)
14 x 14 (4,3x4,3)	14 (53)	11.1 (77)	16 (61)	14.5 (100)
16 x 16 (4,9x4,9)	16 (61)	14.5 (100)	18 (68)	18.4 (127)
16 x 18 (4,9x5,5)	19 (72)	20.5 (141)	20 (76)	22.7 (156)
16 x 20 (4,9x6,1)	22 (83)	27.4 (189)	25 (95)	35.4 (244)

\*Flows shown for 155°F/68°C; see technical datasheet for flows at 175°F/79°C.

5.8 (84) K-factor



**VK460, Part No. 13933**  
**Technical datasheet F\_110205**

- Sprinkler temp = 155°F/68°C and 175°F/79°C
- Patented "flow shaper" design provides the ultimate combination of low flows and starting pressures
- Larger K-factor provides lower starting pressure in NFPA 13 applications (0.1 gpm/ft<sup>2</sup> density)
- Available with ENT plating (Nickel PTFE) for corrosion resistance

12 x 12 (3,7x3,7)	16 (61)	7.6 (52)	16 (61)	7.6 (52)
14 x 14 (4,3x4,3)	16 (61)	7.6 (52)	18 (68)	9.7 (67)
14 x 26 (4,3x7,9)	42 (159)	52.4 (362)	46 (174)	62.9 (434)
16 x 16 (4,9x4,9)	20 (76)	11.9 (82)	24 (91)	17.1 (120)
16 x 18 (4,9x5,5)	22 (83)	14.4 (99)	27 (102)	21.7 (149)
16 x 20 (4,9x6,1)	26 (98)	20.1 (139)	32 (121)	30.4 (210)
16 x 22 (4,9x6,7)	31 (117)	28.6 (197)	37 (140)	40.7(281)
16 x 24 (4,9x7,3)	38 (144)	42.9 (296)	42 (159)	52.4 (362)
18 x 18 (5,5x5,5)	23 (87)	15.7 (110)	29 (110)	25.0 (170)
18 x 20 (5,5x6,1)	29 (110)	25.0 (170)	35 (133)	36.4 (251)
20 x 20 (6,1x6,1)	30 (114)	26.8 (180)	36 (136)	38.5 (266)

\*Flows shown for 155°F/68°C; see technical datasheet for flows at 175°F/79°C.

Residential Sprinkler Quick Reference Guide

Flat Plate Concealed Sidewall Sprinklers Cover plate temp = 135°F/57°C

4.0 (58) K-factor



**VK480, Part No. 16116AC**  
**Technical datasheet F\_121609**

- Sprinkler temp = 165°F/74°C
- Use cover plate 16207MA/W
- The industry's only residential, flat plate concealed, horizontal sidewall sprinkler
- White cover plate is standard; can be custom painted to match any decor
- Available with ENT plating (Nickel PTFE) for corrosion resistance

Coverage Area ft (m)	4-6" (102mm-152mm) From Ceiling		6-12" (152mm-305mm) From Ceiling	
	Flow gpm (lpm)	Pressure psi (kPa)	Flow gpm (lpm)	Pressure psi (kPa)
12 x 12 (3,7x3,7)	11 (42)*	7.6 (52)	12 (46)**	9.0 (62)
14 x 14 (4,3x4,3)	13 (49)*	10.6 (73)	14 (53)**	12.3 (84)
16 x 16 (4,9x4,9)	16 (61)*	16.0 (110)	16 (61)**	16.0 (110)
16 x 18 (4,9x5,5)	17 (64)*	18.1 (125)	18 (68)**	20.3 (140)

\*Centerline of the sprinkler located 4-3/8" (111mm) to 6-3/8" (162mm) below the ceiling.  
 \*\*Centerline of the sprinkler located 6-3/8" (162mm) to 12-3/8" (314mm) below the ceiling.

Upright Sprinklers Available in 155°F/68°C and 175°F/79°C

4.9 (71) K-factor



**VK467, Part No. 19154**  
**Technical datasheet F\_090413**

- The industry's first and only residential upright sprinkler
- May provide significant design advantages in loft-type residential structures
- Listed with beam ceilings up to 14" (356 mm)
- Available with ENT plating (Nickel PTFE) for corrosion resistance

Coverage Area ft (m)	Horizontal Ceiling		
	Flow gpm (lpm)	Pressure psi (kPa)	Deflector to Ceiling
12 x 12 (3,7x3,7)	14 (53)	8.2 (56)	3-5" (76mm- 127mm)
14 x 14 (4,3x4,3)	14 (53)	8.2 (56)	
16 x 16 (4,9x4,9)	16 (61)	10.7 (73)	
12 x 12 (3,7x3,7)	15 (57)	9.4 (65)	6-10" (152mm- 254mm)
12 x 12 (3,7x3,7)	15 (57)	9.4 (65)	
16 x 16 (4,9x4,9)	18 (68)	13.5 (93)	

\*Note: Also applies to installations 1-3" below 14" beams at 155°F/68°C temperature rating only.

Flat Cover Plate Finishes



Standard Finishes

Residential flat cover plates are available in nine standard finishes and a nearly unlimited variety of custom color finishes. Prices and lead times may vary. Flat cover plates shown not actual size [2-3/4" (70 mm) diameter].

Custom Finishes

Custom colors available for cover plates and frame style sprinklers. Special order only. Additional charges will apply. Orders covering special painted products are not subject to cancellation except by written permission and then only upon agreement to make payment for work already performed. Viking reserves the right to over ship special painted products produced in excess of order quantity at no charge. No return of these products is allowed.

Cover Plates Technical datasheet Sprinkler 136a



**Standard, Part No. 13504**  
 2-3/4" (70mm) diameter

**Large, Part No. 13642**  
 3-5/16" (84mm) diameter  
 (Part No. 16207 for VK480)



**Square, Part No. 15394**  
 3-5/16" (84mm) L x W



**Domed, Part No. 12207**  
 3-1/8" (80mm) diameter

Recessed and Sloped Ceiling Escutcheons Technical datasheet Sprinkler 135a



- E-1 – Push-on, Part No. 11123, 06419A, 06420A
- E-2 – Threaded, Part No. 11038, 11625
- F-1 – Adjustable, Part No. 06911A, 06912A



**G-1 – Sloped, Part No. 14315**  
 Push-on

Tools Technical datasheet Sprinkler 135a



**Cabinet Wrench & Sprinkler Cap Removal Tool, Part No. 13619**



Individual tools and length of pipe all sold separately.



**Concealed Cover Installer Tool, Standard Diameter, Part No. 14412**

**Concealed Cover Installer Tool, Large Diameter, Part No. 14867**











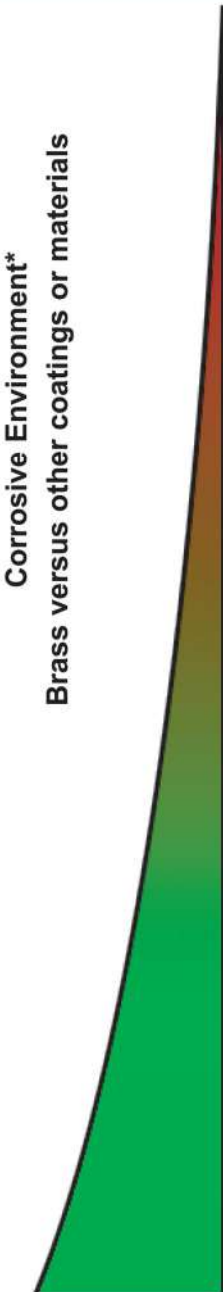

**Escutcheon Installer Tool, Part No. 15166**

# Specialty Sprinklers and Nozzles

This guide is intended for general reference only. Prior to the design, layout, and/or installation of any sprinkler system, please refer to Viking's technical documentation and always consult with the AHJ. Viking makes no representation or warranty as to whether following this guide will satisfy any rule or requirement. Please visit [www.vikinggroupinc.com](http://www.vikinggroupinc.com) for the most current technical data and product specifications. All products must be installed in accordance with the manufacturer's current installation instructions. Viking reserves the right to change product specifications at any time without notice and without incurring obligation.



Corrosion resistant sprinklers are designed to resist exterior elements that attack a standard brass sprinkler. Corrosion resistant sprinklers may have a coating or may be constructed of a corrosion resistant material. The level of corrosion resistance required is determined by the conditions that a sprinkler would experience during its installed lifetime in a corrosive environment.

SPRINKLER IMAGE	DESCRIPTION	CORROSION RESISTANT COATED PARTS	CORROSION RESISTANCE SPECTRUM
	Brass Finish – Provides the least corrosion resistance of any sprinkler finish. Subject to oxidation, (turning green), when exposed to moisture.	No Coated Parts	
	Chrome Finish – An ornamental finish that provides minimally more corrosion resistance than brass only.	Frame Deflector	
	White/Black Polyester Finish – A ornamental finish that provides higher corrosion resistance than chrome or brass. The waterway is not coated.	cUL <sub>US</sub> Frame Deflector	
	Black PTFE** Finish – A finish is applied to sprinkler and pip cap. PTFE has a higher corrosion resistance than a polyester finish. Waterway is only coated in open sprinklers.	cUL <sub>US</sub> Frame Deflector Pip Cap	
	Wax Coated Finish – A brass sprinkler is dipped in wax. The entire sprinkler is coated with the protective covering (except for glass bulb). Waterway is not coated.	cUL <sub>US</sub> Whole Assembly	
	Wax over Polyester Coated Finish – A polyester finished sprinkler is dipped in wax. The entire sprinkler is coated with the protective covering (except for glass bulb). The waterway is not coated.	cUL <sub>US</sub> Whole Assembly	
	Electroless Nickel PTFE** (ENT) – Coating is applied using a non-electric, auto-catalytic process that maximizes the coating's durability and anti-adhesion properties. The sprinkler is thoroughly coated including the water way, screw, and pip cap. The spring is PTFE** coated on both sides.	cUL <sub>US</sub>  Whole Assembly Belleville Spring PTFE Coated	
	Stainless Steel – Designed for corrosive environments that cause brass sprinklers to deteriorate. The frame, deflector, screw, and pip cap are made from solid stainless steel. The spring is made from Nickel Alloy, and PTFE** on both sides.	cUL <sub>US</sub>  Whole Assembly constructed from Stainless Steel	

Note: Corrosion resistance does not mean corrosion proof. A sprinkler's data page indicates its materials of construction.

\*Appropriate finish and parts choice for an environment is the responsibility of the customer.

\*\* PTFE is often better known by the common brand name Teflon®, which is a registered trademark of DuPont  
Refer inquiries about corrosion resistance of a sprinkler to Viking Technical Services.





## Corrosion Resistance | ENT Sprinklers

Viking's ENT\* sprinklers offer a superior level of corrosion resistance compared to other available finishes, and at a lower cost than stainless steel sprinklers. ENT sprinklers are thoroughly protected, including the water way, screw, and pip cap. The result is a sprinkler that will show little to no evidence of corrosion during its lifetime.

### Viking ENT plated sprinklers offer the following benefits:

- Durable, long-lasting protection that resists scratching, chipping and flaking.
- Applied with a non-electric, auto-catalytic plating process that maximizes durability and anti-adhesion properties.
- FM Approved and cULus Listed for corrosion resistance.
- Aesthetically pleasing and suitable for decorative applications.
- More economical than stainless steel alternatives.
- Available on a variety of Viking sprinklers.

\*Polytetrafluoroethylene (PTFE) is known by the common brand name Teflon®, which is a registered trademark of DuPont.

Viking ENT sprinklers are rigorously tested by UL, including three 30-day corrosion tests that represent the sprinkler's typical lifetime exposure in a corrosive environment.\*

- 20% salt spray / fog exposure
- Moist hydrogen sulfide air mixture exposure
- Moist carbon dioxide / sulfur dioxide air mixture exposure

### Ideal for corrosive environments such as:

- Industrial wash down areas
- Chemical processing
- Parking garages
- Mezzanines and balconies

*Note: ENT plating is not recommended for indoor swimming pool areas, or for any area with a high chlorine concentration.*

\*FM test criteria available upon request.



## Preaction Sprinkler DS21 for Dry & Wet Pipe Systems & Saunas - Pendent

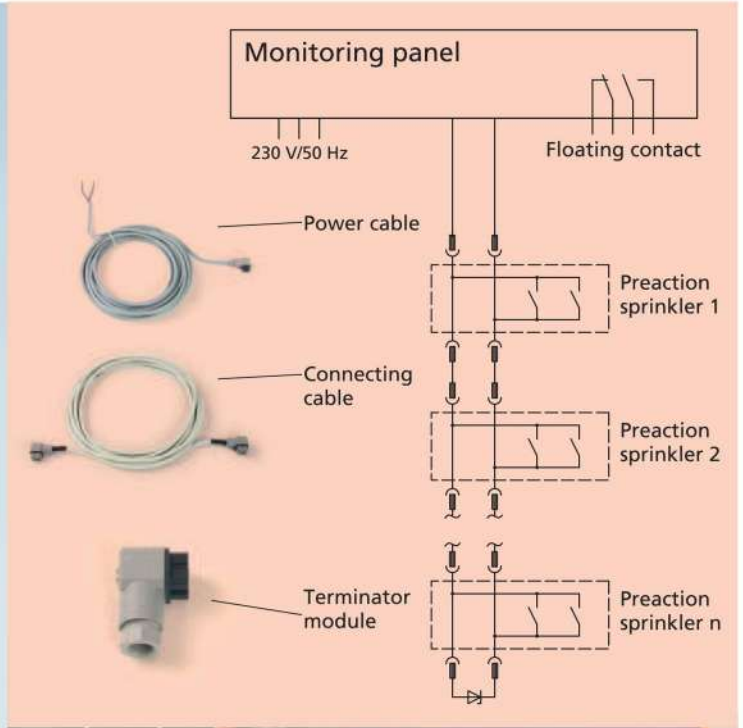

<b>Approvals</b>	
<b>Sprinkler Body</b>	Brass
<b>Response Sensitivity</b>	Quick RTI <math>< 50</math>
<b>Minimum Operating Pressure</b>	3 bar
<b>Maximum Coverage</b>	9m <sup>2</sup>



The preaction sprinkler unit consists of a housing with two separate sprinkler heads. Before water is released, both sprinkler heads in the unit must be triggered.

If only one sprinkler head is triggered, an acoustic or visual alarm signal is generated at the monitoring panel. This allows the operator to respond quickly and repair the damaged sprinkler head, avoiding the risk of water damage.

How does the preaction sprinkler work?

- ▶ When only the sprinkler head to the left (A) has been triggered, the inner tube drops down, allowing the water to flow into the cast metal housing. The lower end of the tube is closed, sealing the sprinkler orifice and preventing water from escaping from the sprinkler head. The water flowing into the housing lifts the float, which triggers a visual and audible alarm signal at the monitoring panel.

- ▶ When only the sprinkler head to the right (B) is triggered, the float drops down, activating a switch. Again, an alarm signal is generated at the monitoring panel.
- ▶ When both sprinkler heads are triggered, extinguishing water is sprayed from the right sprinkler head (B). The alarm valve activates the alarm pressure switch and an alarm signal is sent to a continuously manned control desk.

The preaction sprinkler for dry systems is equipped with an additional pressure switch. When the left sprinkler head is triggered, compressed air flows into the preaction sprinkler housing and activates the pressure switch generating an alarm signal at the monitoring panel.

**Viking Model E  
Spray Nozzles**



**LISTINGS AND APPROVALS**

**cULus Listed:** Category VGYZ

**FM Approved:** Fixed Extinguishing Systems

**TECHNICAL DATA**

Minimum Operating Pressure: 10 psi (0.7 bar)  
 Maximum Working Pressure: 175 psi (12 bar)  
 Thread size: 1/2" (15 mm) NPT  
 Available K-Factors: 7.2(103.7), 5.6(80.6), 4.1(59.0), 3.2(46.1), 2.3(33.1),  
 1.8(25.9), 1.2(17.3)

Spray angle	SIN	Spray angle	SIN
65°	VK810	125°	VK814
80°	VK811	140°	VK815
95°	VK812	160°	VK816
110°	VK813	180°	VK817

**Viking Model C-1  
Window Sprinklers**



**LISTINGS AND APPROVALS**

**cULus Listed:** Category VOKR

**FM Approved:** Class 2014

**TECHNICAL DATA**

Minimum Operating Pressure: 7 psi (0.5 bar)  
 Rated to 175 psi (12 bar) water working pressure  
 They are available in various orifice sizes.

K-Factor U.S. (Metric)	SIN	Thread size
1.5(21.6)	VK790	1/2"(15 mm)
2.1(30.3)	VK791	1/2"(15 mm)
3.0(43.2)	VK792	1/2"(15 mm)
4.3(62)	VK793	1/2"(15 mm)
5.8(83.6)	VK794	1/2"(15 mm)
7.3(105.2)	VK795	3/4"(20 mm) NPT
8.1(116.8)	VK796	3/4"(20 mm) NPT

**Solid Cone  
High Velocity  
Spray Nozzles**



**LISTINGS AND APPROVALS**

**cULus Listed:** Category VGYZ

**FM Approved:** Water-Spray Systems

**TECHNICAL DATA**

Inserts are available in spray angles of 30°, 60°, 90°, 120°, and 140°  
 Thread size: 1/2" (15 mm) NPT male thread is standard

**Dust Plugs (Optional):**

Red Polyethylene Cap: 1"(25 mm) deep  
 Rated for a continuous temperature of 220 °F (104 °C).

Model A2			Model A2X			Model B2			Model C2			Model D2		
K-Factor U.S. (Metric)	Spray Angle	SIN	K-Factor U.S. (Metric)	Spray Angle	SIN	K-Factor U.S. (Metric)	Spray Angle	SIN	K-Factor U.S. (Metric)	Spray Angle	SIN	K-Factor U.S. (Metric)	Spray Angle	SIN
1.2(17)	30°	VK740	2.0(29)	30°	VK750	2.8(40)	30°	VK760	3.4(49)	30°	VK770	4.7(68)	30°	VK780
1.2(17)	60°	VK741	2.0(29)	60°	VK751	2.8(40)	60°	VK761	3.4(49)	60°	VK771	4.7(68)	60°	VK781
1.2(17)	90°	VK742	2.0(29)	90°	VK752	2.8(40)	90°	VK762	3.8(55)	90°	VK772	5.0(72)	90°	VK782
1.4(20)	120°	VK743	2.2(32)	120°	VK753	3.3(48)	120°	VK763	3.9(56)	120°	VK773	5.2(75)	120°	VK783
1.4(20)	140°	VK744	2.2(32)	140°	VK754	3.3(48)	140°	VK764	3.9(56)	140°	VK774	5.2(75)	140°	VK784

**Model M  
Spray Nozzles**



**LISTINGS AND APPROVALS**

**cULus Listed**

**TECHNICAL DATA**

Minimum Operating Pressure: 7 PSI (0.5 bar)  
 Rated to 175 PSI (12 bar) water working pressure.  
 Factory tested hydrostatically to 500 PSI (34.5 bar)  
 Available K factors: 5.6 (80), 4.2 (57), 2.8 (40.3), 1.9 (27.4) and 1.4 (20.2)  
 Available Spray angles: 60°, 90°, 120° and 150°

## Wet System

### Model J-1 Wet Alarm Valve

When a sprinkler (1) opens, the discharging water lifts the alarm valve clapper (2) and flows through the alarm port (3) to the retard chamber (4). When the retard chamber is filled, water flows to the water motor alarm and/or the optional pressure switch (5) which signals an electric alarm bell (6).

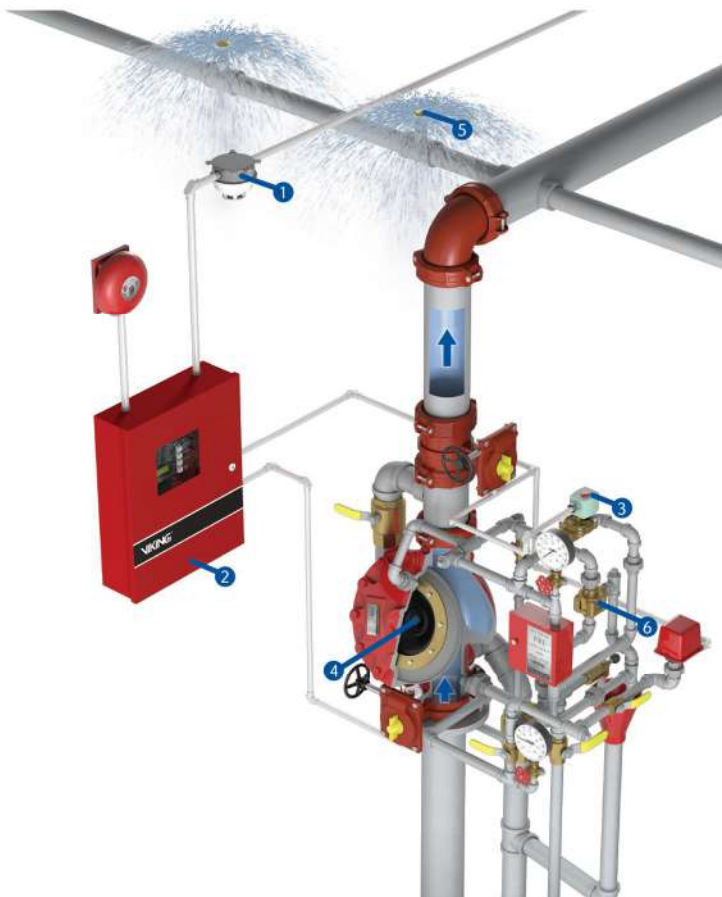
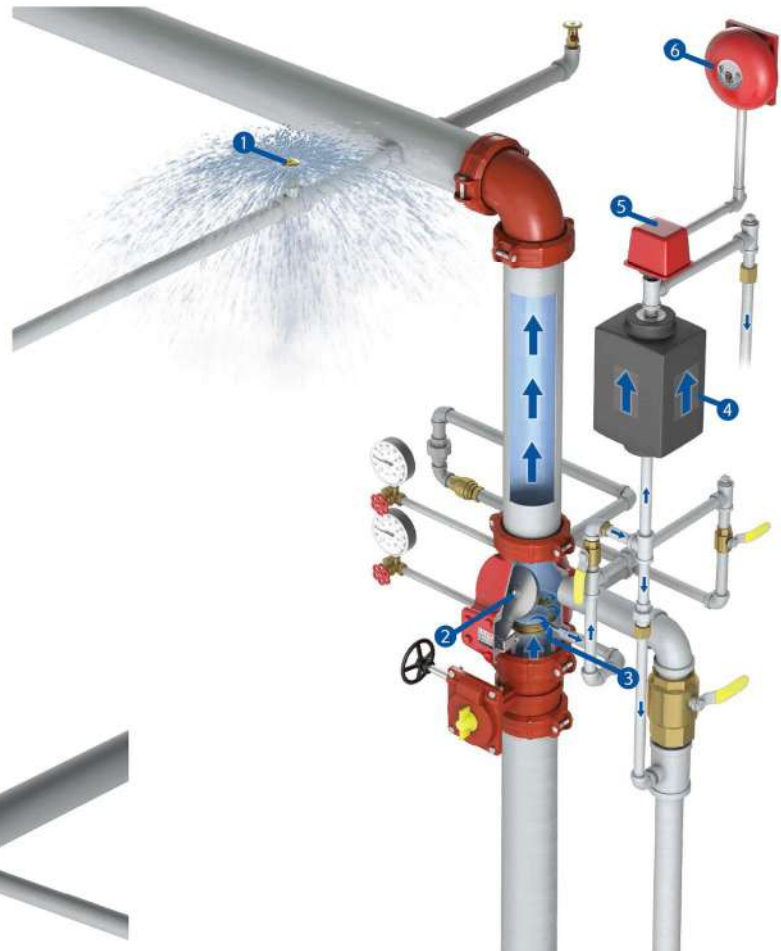

## Deluge System

### Model F-1 Deluge Valve Electric Release

When the detector (1) is activated, a signal is sent to the VFR-400 release control panel (2). The panel sends appropriate alarm signals and, at the same time, energizes the normally closed (NC) solenoid (3) open. The deluge valve priming chamber (4) is then vented faster than water is supplied through the restricted orifice, allowing the deluge valve to open. The water enters the system piping. Water flows from all open sprinklers or nozzles (5). When the deluge valve operates, pressure opens the pressure operated relief valve (PORV) (6) continuously venting the water supply to the priming chamber, ensuring the deluge valve remains in the open position.

## Deluge System

### Model E-1 Deluge Valve Pneumatic Release

When the C-1 Thermostatic Release (1) or fixed temperature release (2) is activated by fire, pressure in the release system escapes from the open device, allowing the pneumatic actuator (3) to open.

This releases pressure from the priming chamber (4) of the deluge valve, allowing the valve to open. Water flows into the system piping and to the alarm devices, causing the pressure switch (5) to activate an electric alarm and/or operate a mechanical water motor alarm. Water flows from all open sprinklers or nozzles (6). When the deluge valve operates, pressure opens the pressure operated relief valve (PORV) (7) continuously venting the water supply to the priming chamber, ensuring the deluge valve remains in the open position.

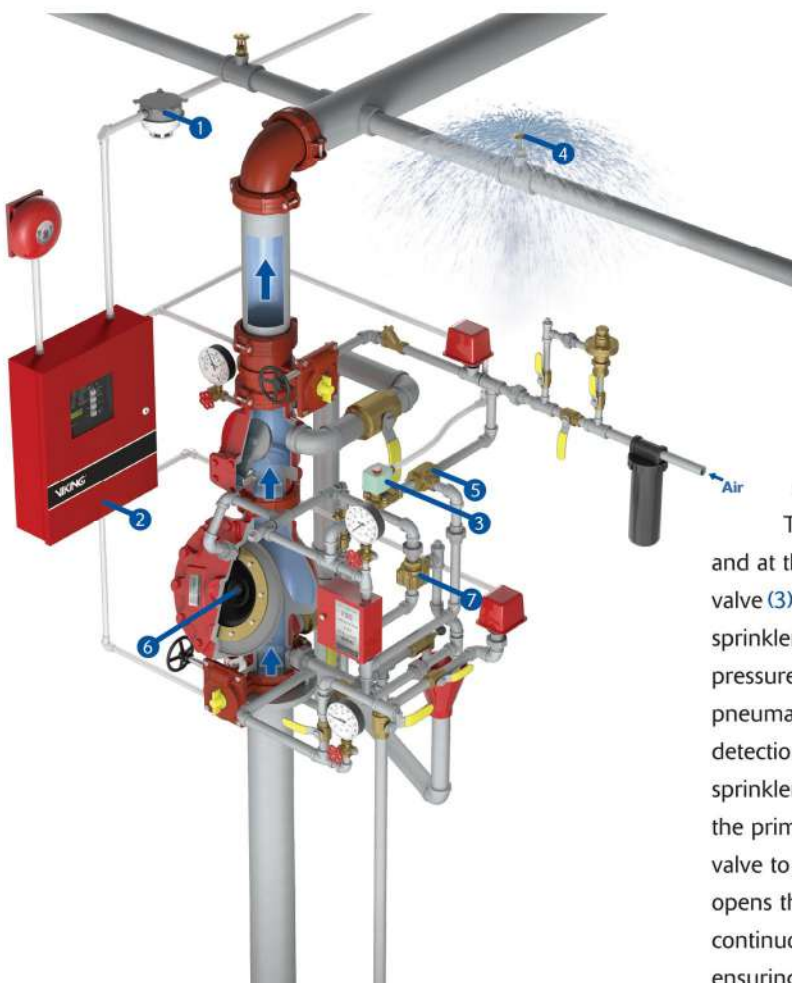
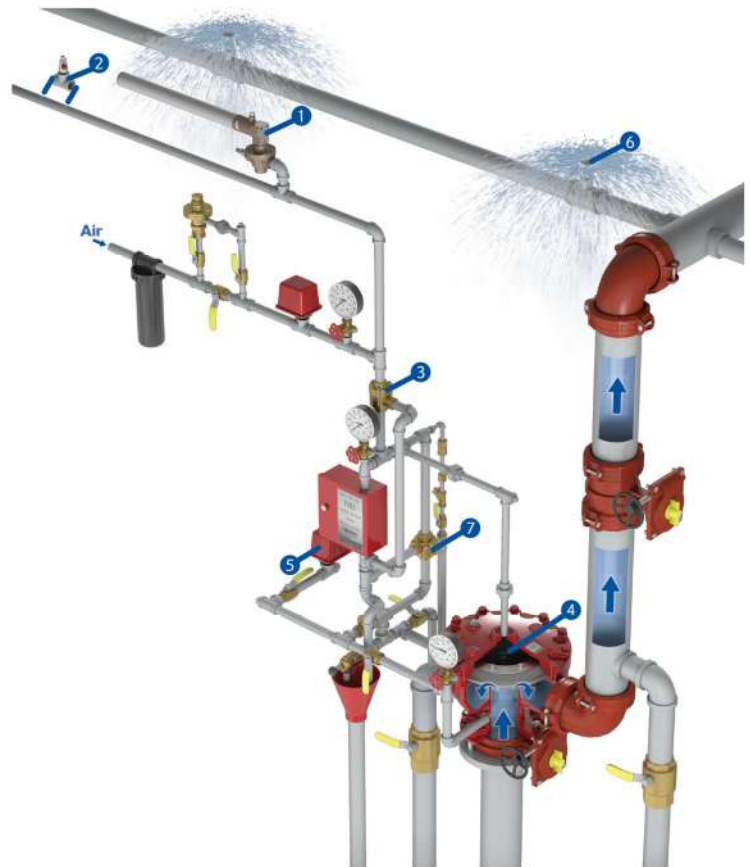

## Preaction System

### Model F-1 Deluge Valve Double Interlock Electric/Pneumatic Release

When the detector (1) is activated, a signal is sent to the VFR-400 release control panel (2).

The panel sends appropriate alarm signals, and at the same time, signals the release of the solenoid valve (3). The deluge valve will NOT open until a sprinkler (4) opens. When a sprinkler opens, supervisory pressure in the sprinkler piping is reduced causing the pneumatic actuator (5) to open. After BOTH the electric detection system activates AND supervisory pressure in the sprinkler system have been lost, pressure is released from the priming chamber (6) of the deluge valve, allowing the valve to open. When the deluge valve operates, pressure opens the pressure operated relief valve (PORV) (7) continuously venting the water to the priming chamber, ensuring the deluge valve remains in the open position.

## SureFire® Single Interlock

*System operation under normal power conditions*

When the detector (1) is activated, a signal is sent to the VFR-400 release control panel (2). The panel sends the appropriate alarm signals, and at the same time, powers the normally closed (N/C) solenoid valve (3) open, releasing pressure from the priming chamber (5) of the deluge valve. The priming chamber (5) of the deluge valve is then vented faster than water is supplied through the restricted orifice (6), allowing the deluge valve to open. The water enters the system piping, but no water is discharged until a sprinkler (7) is activated. Should there be a loss of AC power, the system has battery backup.

*System operation under loss of total AC and battery back-up power*

Should both the AC power and the battery back-up power be lost, the system will still operate as a dry system, as long as there is air pressure in the system piping. Heat from a fire activates a sprinkler (7), which causes a drop in the system air pressure. The system air pressure continues to drop until the pneumatic actuator (8) opens. The priming chamber (5) of the deluge valve is then vented through the normally open (N/O)

solenoid valve (4) and pneumatic actuator (8) faster than water is supplied through the restricted orifice (6), which opens the deluge valve. This will open the pressure operated relief valve (PORV) (9) which will continuously vent the prime water, ensuring the deluge valve remains in the open position. Water is then discharged out of the sprinklers opened by the fire.

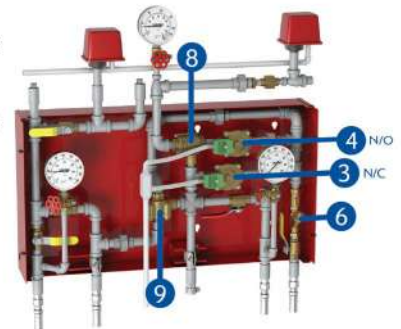
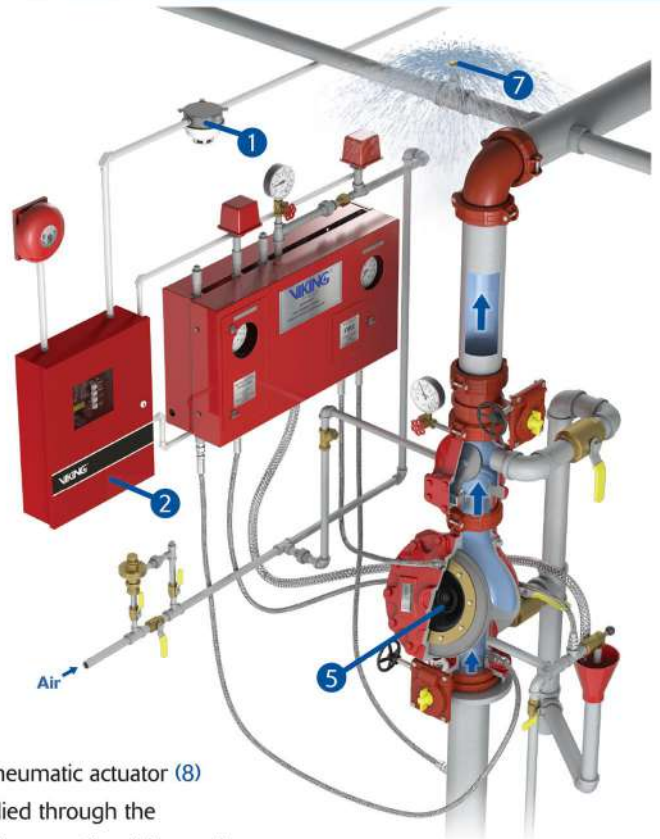

## Dry System

*Model F-1 Dry Pipe Valve*

When a sprinkler (1) opens, loss of air pressure in the system allows the dry valve clapper (2) to open, filling the system with water. To speed the opening of the dry valve in large systems, an accelerator (3) can be added. An integral anti-flood device protects against accelerator flooding. Water flow from the intermediate chamber of the dry valve can cause a pressure switch (4) to activate an electric alarm and/or operate a mechanical water motor alarm.

## Dry System

### G Series Dry Valve Riser Assembly

When a sprinkler (1) opens, loss of air pressure in the system allows the differential valve (2) to open and relieve the priming pressure from the internal prime chamber assembly (3), opening the valve, and filling the system with water. To speed the opening of the G Series dry valve in large systems, a model E-1 accelerator (4) can be added.

Water flow from the intermediate chamber of the dry valve can cause a pressure switch (5) to activate an electric alarm and/or operate a mechanical water motor alarm. When the valve operates, pressure opens the pressure operated relief valve (PORV) (6) continuously venting the water supply to the priming chamber, ensuring the dry valve remains in the open position.

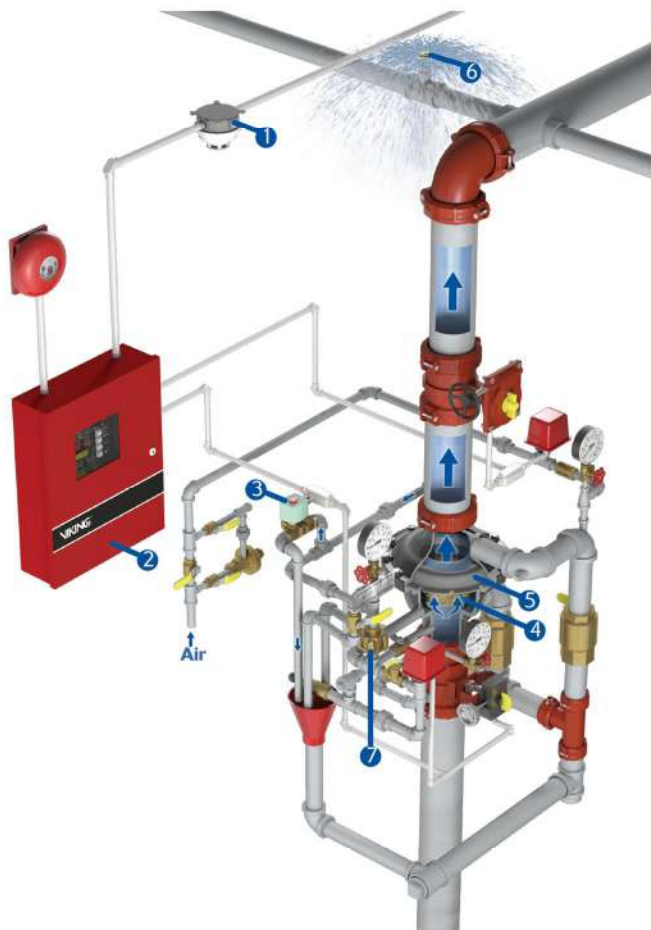
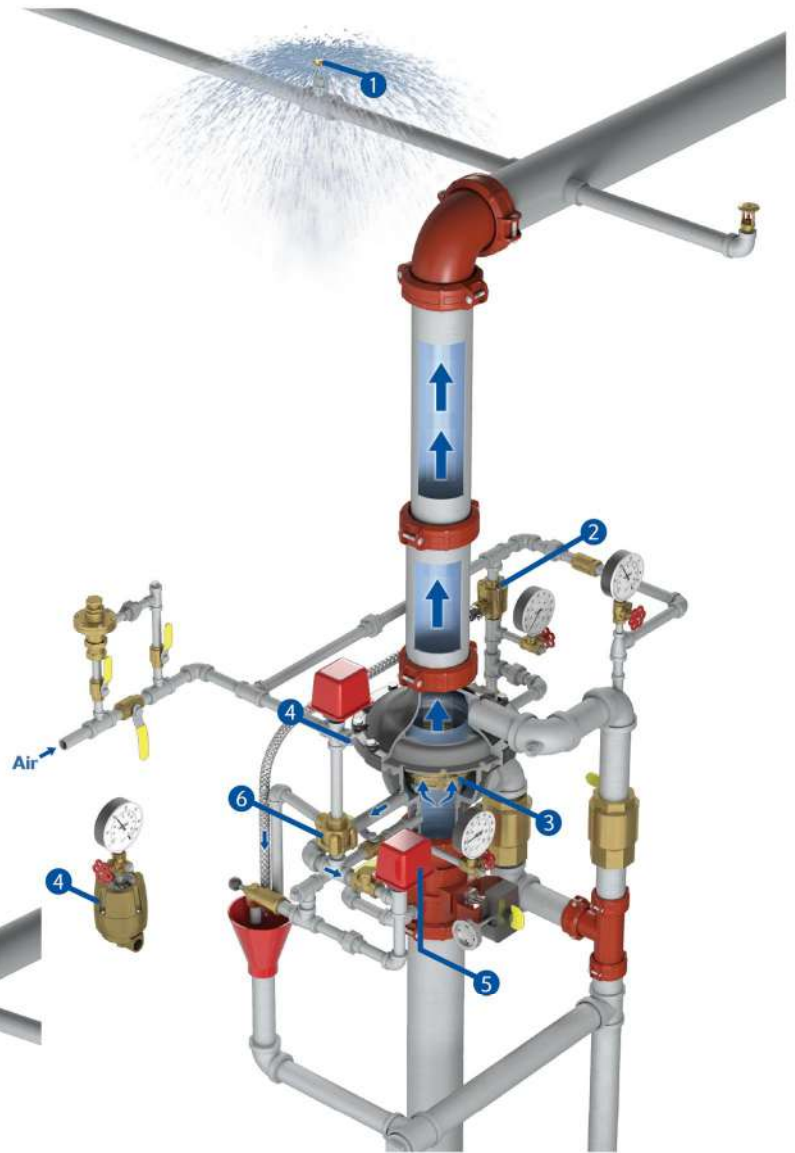

## Preaction System

### Single Interlock Electric Release

When the detector (1) is activated, a signal is sent to the VFR-400 release control panel (2). The panel sends appropriate alarm signals, and at the same time, signals the release of the solenoid valve (3). When the solenoid opens, the priming water is relieved from the internal prime chamber assembly (4). The prime chamber assembly collapses, and water passes through the G series valve and internal check diaphragm (5). The water enters the system piping, but until a sprinkler (6) activates no water is discharged. When the valve operates, pressure opens the pressure operated relief valve (PORV) (7) continuously venting the water to the priming chamber, ensuring the deluge valve remains in the open position.

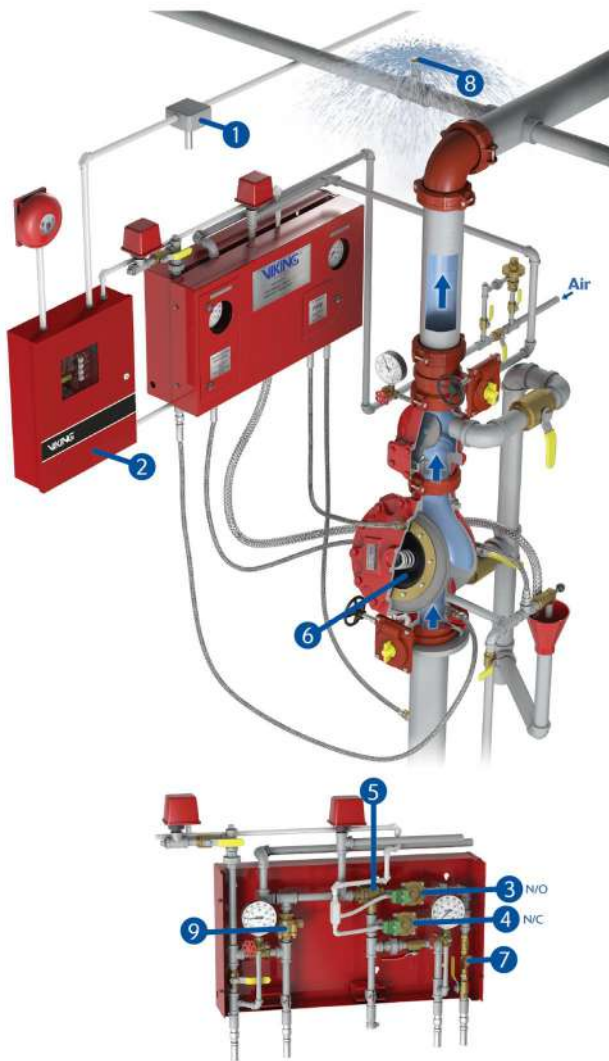

## Firecycle III® Single Interlock

### Cycling Single Interlock

When the detector (1) is activated, a signal is sent to the VFR-400 release control panel (2). The panel sends the appropriate alarm signals and, at the same time, powers the normally open (N/O) (3) and normally closed (N/C) (4) solenoid valves, isolating the pneumatic actuator (5) and releasing pressure from the priming chamber (6) of the flow control valve is then vented faster than water is supplied through the restricted orifice (7), allowing the flow control valve to open. The water enters the system piping, but until a sprinkler (8) is activated no water is discharged. When the flow control valve operates, pressure opens the pressure operated relief valve (PORV) (9) continuously venting the water to the priming chamber, ensuring the deluge valve remains in the open position. After the detectors cool (reset) the VFR-400 activates the "soak timer", allowing the system to continue discharging water for a preset time period. After the "soak timer" has expired, the normally closed solenoid is allowed to close and reestablish prime pressure, and stop the flow of water. If the detector senses a flare-up of the fire, the cycle begins again. If the detector never cools completely, or is damaged, the system will continue to discharge water.

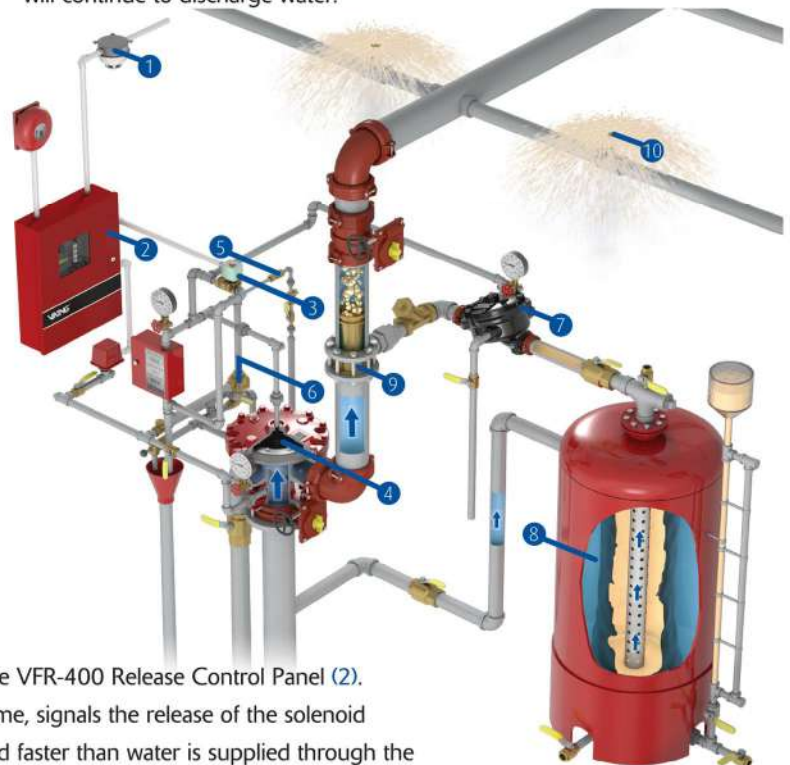

## Foam/Water Deluge Sprinkler System

When the detector (1) is activated by fire, a signal is sent to the VFR-400 Release Control Panel (2). The panel sends appropriate alarm signals and, at the same time, signals the release of the solenoid valve (3). The deluge valve priming chamber (4) is then vented faster than water is supplied through the restricted orifice (5), allowing the deluge valve to open. When the deluge valve operates, pressure opens the pressure operated relief valve (PORV) (6) continuously venting the water to the priming chamber, ensuring the deluge valve remains in the open position. Trim piping, tied into the priming chamber of the Halar-coated concentrate control valve (7), allows that valve to open at approximately the same time, opening the foam concentrate line to the sprinkler system. The outer shell of the bladder tank (8), pressurized by system water, squeezes foam concentrate out to the proportioner (9). As water flows through the venturi area of the proportioner, a metered pressure drop draws foam concentrate into the system water creating a foam solution mixed to the appropriate ratios. This solution then flows through the sprinkler piping and out to the open sprinklers or nozzles (10).





## Model FSX-A Deluge System

### Mode of activation

#### Electric activation

Electric activation of the deluge valve set is accomplished by means of a detection system, which triggers the solenoid valve in the event of fire. The solenoid valve opens, the pressure in the deluge valve control chamber drops and the nozzle pipe work will be flooded.

#### Electric activation with PORV

In case of a power failure the PORV valve ensures that the valve remains open and water continues to flow.

#### Remote activation

Allows the valve to be opened *and closed* remotely from the valve.

#### Hydraulic activation

For hydraulic activation a pilot line is directly connected to the control chamber of the deluge valve. The system pressure of the water supply permanently charges the pilot line. Should a pilot sprinkler release, the pressure in the control chamber drops and the deluge valve opens.

#### Manual activation

All FSX-A valves are equipped with a ball valve inside the emergency release box for manual activation.

Material / Surface of the Deluge valve:	
Housing	ductile iron
Valve seat	brass
Piston rod	stainless steel
Valve disk	brass
Diaphragm	NBR fiber-reinforced
Gaskets	NBR
Finish	RAL 3000 primer & varnish

<b>Approvals</b>	UL, CCCF
<b>Nominal diameter</b>	DN50 / 2" , DN80 / 3" , DN100 / 4" , DN150 / 6" , DN200 / 8"
<b>Max. operating pressure</b>	17,2 bar / 250 PSI
<b>Flange connection sizes</b>	ANSI B16.5 CLASS 150 / DIN ISO in acc. with DIN EN 1092
<b>Installation position</b>	Vertical
<b>Medium</b>	fresh water / foam water mixture
<b>Operating temp.</b>	4°C / 39°F up to 60°C / 140°F
<b>Alarm</b>	alarm switch with changeover contact 1 NO contact, 1 NC contact;
<b>Activation</b>	electric 24 V DC 2/2-way solenoid valve / hydraulic activation (Sprinkler) / hand operated
<b>Automatic drain valve</b>	K 2- K20

## Seismic Bracing



Fig. 75  
Swivel  
Attachment



Fig. 98B  
Rod Stiffener with  
Break Off Bolt Head



Fig. 4A  
Pipe Clamp For  
Sway Bracing



Fig. 4L  
Longitudinal "In-  
Line" Sway Brace  
Attachment



Fig. 4LA  
Longitudinal "In-  
Line" Sway Brace  
Attachment



Fig. 800  
Adjustable Sway  
Brace Attachment  
To Steel



Fig. 825  
Sway Brace  
Attachment  
to Steel



Fig. 828  
Universal Sway  
Brace Attachment  
to Steel



Fig. 825A  
Sway Brace  
Attachment to Steel



Fig. 906  
Sway Brace  
Multi-Fastener  
Adapter



Fig. 907  
Multi-Angle  
Attachment



Fig. 909  
No-Thread Swivel  
Sway Brace  
Attachment



Fig. 910  
Threaded  
Swivel Sway  
Brace  
Attachment



Fig. 975  
Straight Sway  
Brace Fitting



Fig. 980  
Universal Swivel Sway  
Brace Attachment



Fig. 1000  
Fast Clamp Sway  
Brace Attachment



Fig. 1001  
Sway Brace  
Attachment



Fig. 2002  
Sway Brace  
Attachment

## Concrete Inserts



Fig. 109A  
Concrete Deck Insert



Fig. 109AF  
Concrete Insert



B2500  
(TOLCO 310)  
Light Duty Spot Insert



N2500  
(TOLCO 310N)  
Steel Insert Nut



B3014  
(TOLCO 309)  
Malleable Iron  
Spot Insert



B3014N  
(TOLCO 309N)  
Malleable Iron  
Insert Nut



## Flow Switches



### VSR

#### Waterflow Alarm Switch

- NEMA 4 solid metal enclosure
- Factory installed neoprene gasket
- 0-90 second field replaceable pneumatic retard
- 450 psi system pressure rated
- Schedule 5-40 pipe
- Synchronized switch action
- 5-year warranty
- Listings: UL, cUL, FM, LPCB, CSFM, NYMEA, and CE

VSR-EU has a 30 second retard and is VdS, EN 12259-5 and LPCB approved



### VS-SP

#### Special Application Waterflow Switch Without Retard

- NEMA 4 solid metal enclosure
- Factory installed neoprene gasket
- 250 psi system pressure rated
- One SPDT (Form C) contact second set of contacts optional
- 1" solid brass threaded bushing
- Twelve paddles provided for use on plastic, copper, and schedule 40
- 5-year warranty
- Listings: UL, cUL, CSFM, NYBSA, and CE



### VSR-AT

#### Waterflow Alarm Switch with Auto Test Feature

- Performs functional test without discharging water
- Conserves water
- Eliminates environmental concerns from sprinkler system discharge
- Reduces corrosion
- Test is initiated by ATC Key switch or any addressable fire panel
- Operates on 24 vdc power from fire panel
- Listings: UL, cUL, FM



#### Auto Test Control Plate

- Initiates Auto Test feature in VSR-AT
- Momentary push button test switch
- Key switch to enable/disable the push button
- LED indicator



## Pressure Switches

### PS Series

#### Pressure Type Waterflow Alarm/Supervisory Switch



- NEMA 4 solid metal enclosure
- Factory installed neoprene gasket
- Pressure range: 4-15 psi (PS10), 5-30 psi (PS15), 10-60 psi (PS40), 25-175 psi (PS120)
- 300 psi system pressure rated
- ½" male NPT fitting
- Two ½" knockouts for dual voltage applications
- Separate isolated wiring chambers eliminate NEC questions regarding multi-voltage applications
- Factory set for operation at:
  - PS10 Pressure Increase at 6 psi, Pressure Decrease at 5 psi
  - PS15-2 Pressure decrease at 10 psi, Pressure increase at 20 psi
  - PS40-1 Pressure Decrease at 30 psi
  - PS40-2 Pressure Increase at 50 psi, Pressure Decrease at 30 psi
  - PS120-1 Pressure Decrease at 110 psi
  - PS120-2 Pressure Increase at 130 psi, Pressure Decrease at 110 psi
- 5-year warranty
- Listings: UL, cUL, CSFM, FM, LPC, NYMEA, and CE

'VdS' is listed with UL, FM, VdS, CUL, LPCB, and CSFM

### PCS/ADPS

#### Pump Control Switch/Adjustable Deadband Pressure Switch



- Independent set and reset points
- Adjustable operating range 25-300 PSIG
- 12 PSI minimum deadband
- NEMA 4X enclosure for indoor or outdoor use
- Horsepower rating:
  - PCS: 1/2HP
  - ADPS: 1/8 HP
- Listings: UL, CE, and CSA

### PS15

#### Pressure Supervisory Switch for Low Pressure Systems



- NEMA 4 solid metal enclosure
- Factory installed neoprene gasket
- 300 psi system pressure rated
- Pressure range 5-30 psi
- ½" male NPT fitting
- Two ½" knockouts for dual voltage applications
- Separate isolated wiring chambers eliminate NEC questions regarding multi-voltage applications
- Factory set for operation at 20 psi on pressure increase and 10 psi on pressure decrease
- 5-year warranty
- Listings: UL, ULC, CSFM, FM, LPC, NYMEA, and CE
- Typically used on excess pressure systems

### BVL

#### Lever Type Bleeder Valve



- For use as a test valve for supervisory pressure switches on dry pipe and preaction sprinkler systems
- Should be installed in-line with pressure switch and gauge
- Convenient means for removal or testing the pressure actuated device without affecting the pressure in the system
- ½" NPT connections
- Recommended for Nitrogen Systems to conserve Nitrogen and reduce wear on generators



## Tamper Switches



### **OSYSU-1 & 2**

#### Outside Screw & Yoke Valve Supervisory Switch

- NEMA 6P (Submersible)
- Factory installed neoprene gasket
- OSYSU-1: One set of SPDT (Form C)
- OSYSU-2: Two sets of SPDT (Form C)
- Fits 1/2"-12" valves
- Fully adjustable stainless steel trip rod cuts installation time by 75%
- Mounting nuts with captive washers reduces installation time
- Installs on OS&Y valves in any position
- 5-year warranty
- Listings: UL, cUL CSFM, FM, NYMEA, and CE



### **PCVS-2**

#### Control Valve Supervisory Switch

- NEMA 6P (Submersible)
- Factory installed neoprene gasket
- PCVS-2: Two sets of SPDT (Form C)
- 1/2" male NPT fitting
- Fully adjustable stainless steel trip rod
- Installs on wall and post indicator valves, butterfly valves in any position
- 5-year warranty
- Listings: UL, cUL, CSFM, FM, NYMEA, and CE



### **PTS-C**

#### Plug Type Supervisory Switch

- NEMA 6P submersible
- Factory installed neoprene gasket
- SPDT contacts 100mA at 28 VDC/AC, 250mA at 12 VDC/AC
- SPDT cover tamper 250mA at 28 VDC/AC
- Dimensions 7"L x 3.75"W x 3"D (including bracket)
- Temperature rating -40°F to 140°F
- 5-year warranty
- Listings: UL, cUL, FM, NYMEA, and CSFM
- For non-rising stem valves and other special applications



### **WLS**

#### Tank Water Level

- NEMA 4 solid metal enclosure
- Detection range before 3" rise/ before 3" fall of water level
- Detection of 12" drop in water level
- Maximum pressure 175 psi
- Used on steel or wooden tanks
- Works on pressure or gravity tanks
- Listings: UL, NYMEA, and CSFM



## Explosion Proof Devices



### ***PIVS-U-EX***

#### Explosion Proof Post Indicator Valve Switch

- Installs on post indicator valves and butterfly valves
- ½" mounting nipple
- Contact rating: 15 AMPS at 125 VAC, 1/2 AMP at 125 VDC
- -40° to 140°F
- UL listed enclosure NEMA 1, 7, 9



### ***PIVSU-EX-O***

#### Outdoor Explosion Proof Post Indicator Valve Switch

- Installs on post indicator valves and butterfly valves
- ½" mounting nipple
- Contact rating: 15 AMPS at 125 VAC, 1/2 AMP at 125 VDC
- -13°F to 185°F
- UL listed enclosure NEMA 1, 3, 4, 4X, 6, 6P, 9 & 13 IP66 and 67



### ***OSYS-U-EX***

#### Explosion Proof OS & Y Switch - Universal

- Installs on OS & Y valves ½"-2"
- Contact rating: 15 Amps at 125 VAC, 1/2 Amp at 125 VDC
- -40° to 140°F
- UL listed enclosure NEMA 1, 7, 9



### ***OSYSU-EX-O***

#### Outdoor Explosion Proof OS & Y Switch

- Installs on OS & Y valves ½"-2"
- Contact rating: 15 Amps at 125 VAC, 1/2 Amp at 125 VDC
- -13°F to 140°F
- UL listed enclosure NEMA 1, 3, 4, 4X, 6, 6P, and 13
- Water tight, dust tight, and corrosion resistant for outdoor use



### ***PS10-EX and PS40-EX***

#### Explosion Proof Pressure Switches

- NEMA 4 and 9 solid metal enclosure
- 300 psi system rated pressure
- ½" NPT male brass fitting
- PS10-EX set for operation at:
  - Two switches operate on pressure increase at 6 psi
  - Two switches operate on pressure decrease at 5 psi
- PS40-EX set for operation at:
  - One switch operates on pressure decrease at 30 psi
  - Second switch operates on pressure increase at 50 psi
- 1-year warranty
- Listings: UL, cUL, CSFM, FM, NYMEA, and ATEX



### ***VSR-FEX***

#### Explosion Proof Vane Type Waterflow Switch

- NEMA 4 and 9 solid metal enclosure
- 0-90 second pneumatic retard
- 450 psi system pressure rated
- Non-corrosive saddle bushing
- Two ½" threaded connections for conduit
- Pipe schedules 10-40 sizes 2"-8"
- 1-year warranty
- Listings: UL, cUL, CSFM, ATEX, and FM

# Riser Mount Air Compressors for Dry Pipe Sprinkler Systems

## OL Plus Series



This oilless riser mounted air compressor is CE marked.



- Oil Less Piston Compressor
- UL Listed Pressure Switch
- Riser Mounting Kit included
- Bubble tight air check valve
- Permanently lubricated bearings
- Integrated Air Intake Filters
- Customized Motor Windings
- Fully automatic, direct drive
- 50 Hz (cycle)
- **Max Pressure: 4.1 BAR**

- Specifically designed to fill the system to 2.7 BAR in 30 minutes

System Capacity**	Model Number	Average LPM*	Motor KW / HP	Minimum Wire Size +	Dimensions (mm)			Weight (Kg)
					L	W	H	
390 L	OL39012AC-50	35.4	0.12 / 1/6	3 mm <sup>2</sup>	407	305	305	13.6
750 L	OL75025AC-50	68.0	0.25 / 1/3	3 mm <sup>2</sup>	407	305	305	14.1
1140 L	OL114056AC-50	103.0	0.56 / 1/2	3 mm <sup>2</sup>	407	381	254	17.2
1350 L	OL135075AC-50	123.0	0.75 / 3/4	5 mm <sup>2</sup>	432	381	254	21.8
1965 L	OL1965120AC-50	178.0	1.2 / 1	5 mm <sup>2</sup>	432	381	254	21.8
2870 L	OL2870150AC-50	260.0	1.5 / 1 1/2	6 mm <sup>2</sup>	585	381	254	27.3

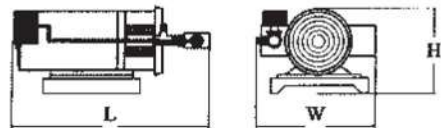

### Accessories Required By Code:

#### Magnetic Line Starters - Thermal Overload Protection

##### Single Phase

	220/240V	Size	Model
Maximum HP	1 HP	00	MG00A
	2 HP	0	MGX0A
	3 HP	1	MG01A
	5 HP	1P	MG15A

When Ordering a Motor Starter you **must** specify HP, Voltage and Phase that is supplied to the motor.

#### VOLTAGE: All Units 220-240 volt

\* "Average LPM" is the average free air delivery from 0 to 2.7 BARG (0 to 40 PSIG).

+ Based on 30 meter run at weakest electrical supply. Consult Factory for longer or shorter runs.

\*\* Based on 21°C system temp.

For other conditions consult factory for pump up times.

++ OLRTK Riser Tank Kit may be required, consult factory.



#### SINGAPORE

##### **The Viking Corporation (Far East) Pte Ltd**

69 Tuas View Square,  
Westlink Techpark,  
Singapore 637621.

Telephone: +65-6278-4061

Facsimile: +65-6278-4609

Mobile: +65-9780-2478

Email: [ycpang@vikingcorp.com](mailto:ycpang@vikingcorp.com)

#### CHINA

##### **Viking Fire Protection Equipment Trading (Shanghai) Co., Ltd**

2nd Floor, Building 2, No.1, Lane 2328  
Chunshen Road, Shanghai,  
China 201100.

Telephone: +86-21-6091-3262

Facsimile: +86-21-6116-9065

Email: [vikingchina@vikingcorp.com](mailto:vikingchina@vikingcorp.com)

#### HONG KONG

##### **Viking Supply Network (Hong Kong) Limited**

Unit , 6th Floor,  
Gee Hing Chang Industrial Building  
No. 16 Cheung Yue Street  
Cheung Sha Wan, Kowloon,  
Hong Kong

Telephone: +852-2391-1078

Facsimile: +852-2787-6063

Email: [aee@vikingcorp.com](mailto:aee@vikingcorp.com)

#### INDIA

##### **Viking Fire Products (India) Pte Ltd Office**

No. 138, 1st Floor, SRS Tower, 14/5, Main Mathura  
Road, Near Metro Station, Mewla, Maharajpur,  
Faridabad - 121003 Haryana, India

Telephone: +91-9891161780

Email: [sgupta@vikingcorp.com](mailto:sgupta@vikingcorp.com)

#### JAPAN

##### **The Viking Corporation (Japan)**

AIOS Gotanda Ekimae Building 4th Floor  
1-11-1 Nishigotanda, Shinagawa-ku  
Tokyo 141-0031, Japan

Telephone: +81-3-6303-9571

Facsimile: +81-3-6303-9572

Email: [kyoshimasu@vikingcorp.com](mailto:kyoshimasu@vikingcorp.com)

#### SOUTH KOREA

##### **Viking Korea Limited**

513-1 Daeyami-Dong Gunpo City  
Gyeonggi-Do  
Korea 435-060

Telephone: +82-31-502-2510

Facsimile: +82-31-438-0137

Email: [jhwang@vikingcorp.com](mailto:jhwang@vikingcorp.com)

**Worldwide Fire Protection**

**Printed on January 2017**

Our Preferred Distributor:



**PT. Citra Makmur Bina Sahabat**  
Fire Protection Engineering  
[www.citramakmur.co.id](http://www.citramakmur.co.id)



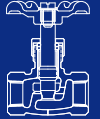

## Outside Screw and Yoke (OS&Y) Gate Valve

### T1040

#### Technical Features

- **Sizes available (Nominal)** : DN15/1/2", DN20/3/4", DN25/1", DN32/1 1/4", DN40/1 1/2" and DN50/2",
- **Pressure data** :  
Working pressure : 12.1 bar (175 psi).
- **Finish** : Cast Bronze.
- **Connections** : Female threaded NPT inlet and outlet.

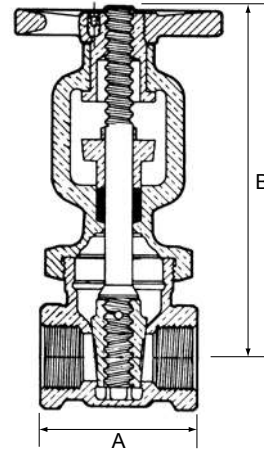

Trim Valves



#### Outside Screw and Yoke (OS&Y) Gate Valve - T1040

Physical Data

Nominal Pipe Size		Dimensions (mm / inch)		Handwheel Diameter (mm/in)	Reference		Weight (kg./lb.)
Metric	inch	A	B		Europe	America/Asia	
DN15	1/2"	59 / 2.19	149 / 5.88	88 / 3.25	T1040050	T1040-50	1.04 / 2.28
DN20	3/4"	62 / 2.44	164 / 6.44	88 / 3.25	T1040075	T1040-75	1.29 / 2.83
DN25	1"	73 / 2.88	189 / 7.44	88 / 3.25	T1040100	T1040-0100	1.67 / 3.67
DN32	1 1/4"	79 / 3.13	221 / 8.69	100 / 4.00	T1040125	T1040-0125	2.65 / 5.83
DN40	1 1/2"	84 / 3.38	238 / 9.38	100 / 4.00	T1040150	T1040-0150	3.11 / 6.84
DN50	2"	87 / 3.44	269 / 10.59	89 / 3.50	T1040200	T1040-0200	4.44 / 9.74

#### OS&Y Gate Valve - T1040

Materials List

Item	Description	Material	Specification
1	Set Screw	Steel	ASTM A307
2	Handwheel	Malleable Iron	
3	Yoke Bushing	Brass	ASTM B16
4	Gland Bolts	Steel	ASTM A307 Zinc Plated
5	Packing Gland	Bronze	ASTM B62
6	Packing	Non-asbestos	Aramid Fibres w/Graphite
7	Bonnet	Bronze	ASTM B62
8	Stem	Silicon Bronze	ASTM B371 Alloy C69430
9	Stem Collar	Silicon Bronze	ASTM B371 Alloy C69430
10	Wedge Pin	Bronze	ASTM B140 Alloy C31400
11	Wedge	Bronze	ASTM B62
12	Body	Bronze	ASTM B62

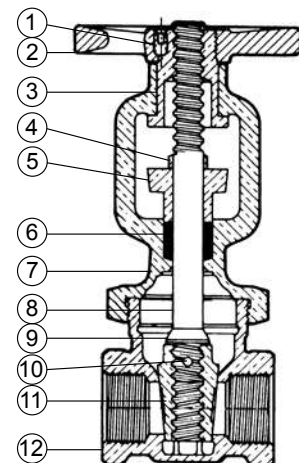

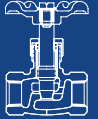

## Globe Trim and Drain Valve

### KT65UL

#### Technical Features

- **Sizes available (Nominal) :** DN15/1/2", DN20/3/4" and DN25/1".
- **Pressure data :**  
Working pressure : 12.1 bar (175 psi).
- **Finish :** Cast Bronze.
- **Connections :** Female Threaded NPT inlet and outlet.

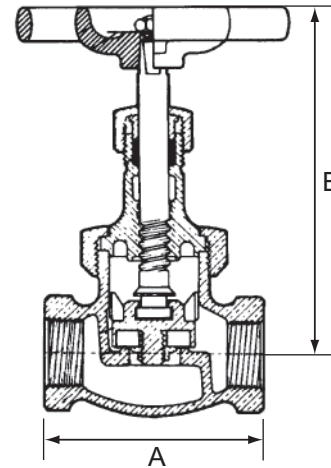

Trim Valves

#### Globe Trim and Drain Valve - KT65UL

#### Physical Data

Nominal Pipe Size		Dimensions (mm / inch)		Reference		Weight (kg/lbs)
Metric	inch	A	B	Europe	America/Asia	
DN15	1/2"	58 / 2.28	79 / 3.12	KT65UL050	KT65UL-0050	0.31 / 0.68
DN20	3/4"	58 / 2.28	79 / 3.12	KT65UL075	KT65UL-0075	0.34 / 0.74
DN25	1"	79 / 3.12	114 / 4.50	KT65UL100	KT65UL-0100	0.76 / 1.68

#### Globe Trim and Drain Valve - KT65UL

#### Materials List

Item	Description	Material	Specification
1	Handwheel	Aluminium	
2	Handwheel Screw	Carbon Steel (1/2" & 3/4") Stainless Steel (1")	
3	Stem	Bronze	ASTM B-584 Alloy C84400
4	Packing Nut	Bronze	ASTM B-584 Alloy C83600 or ASTM B-16
5	Packing	Graphite Impregnated	Non Asbestos
6	Bonnet	Bronze	ASTM B-584 Alloy C84400
7	Body	Bronze	ASTM B-584 Alloy C84400
8	Seat Disc	EPDM Rubber	Commercial
9	Seat Screw	Stainless Steel	
10	Gasket	Aramid Fiber	
11	Pack Washer	Sheet Brass	

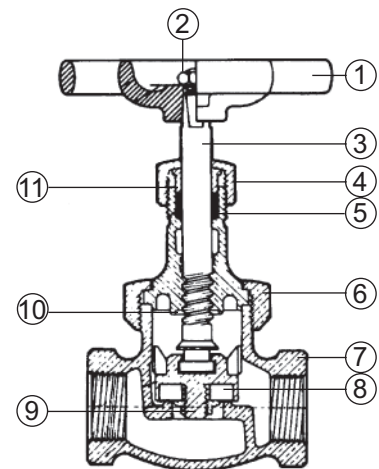

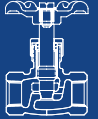

## Swing Check Valve (Threaded)

### NRV

#### Technical Features

- **Sizes available (Nominal) :** DN15/1/2", DN20<sup>3</sup>/<sub>4</sub>", DN25/1", DN32/1<sup>1</sup>/<sub>4</sub>", DN40/1<sup>1</sup>/<sub>2</sub>" and DN50/2".
- **Pressure data :**  
Working pressure : 16 bar (232 psi)
- **Seat type :** Resilient disc
- **Finish :** Cast Bronze
- **Connections :** Female threaded BSP inlet and outlet.

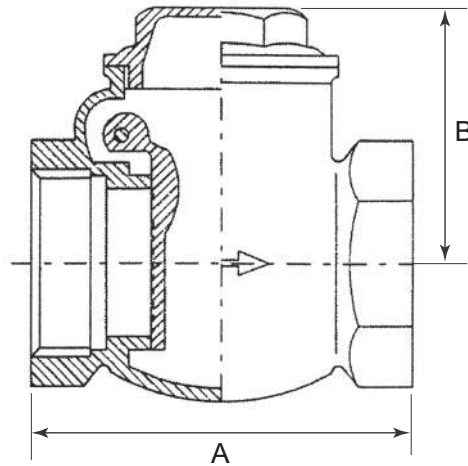

# Trim Valves

### Swing Check Valve (Threaded) - NRV

#### Physical Data

Nominal Pipe Size		Dimensions (mm / inch)		Reference	Weight (kg/lbs)
Metric	inch	A	B		
DN15	1/2"	75 / 3.0	78 / 3.1	NRV004015	1.50 / 3.3
DN20	3/4"	75 / 3.0	98 / 3.8	NRV004020	1.80 / 4.0
DN25	1"	80 / 3.2	112 / 4.4	NRV004025	2.18 / 4.8
DN32	1 <sup>1</sup> / <sub>4</sub> "	92 / 3.6	125 / 4.9	NRV004032	3.43 / 7.6
DN40	1 <sup>1</sup> / <sub>2</sub> "	99 / 3.9	146 / 5.7	NRV004040	4.50 / 9.9
DN50	2"	112 / 4.4	170 / 6.7	NRV004050	5.57 / 12.3

### Swing Check Valve (Threaded) - NRV

#### Materials List

Item	Description	Material	Specification	
1	Body	Bronze	BS 1400 - LG2,	ASTM B62
2	Cap	Brass	BS 2872 - CZ122,	ASTM B124
3	Disc	Resilient (Nitrile)	Commercial	

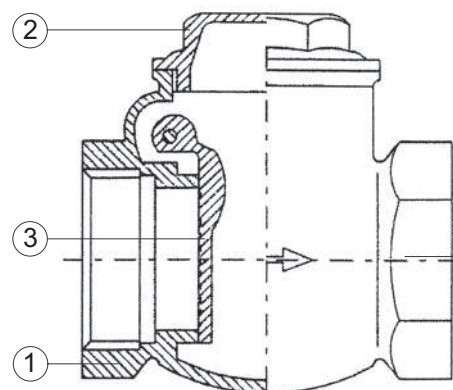

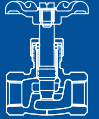

## Ball Valve (Threaded), Standard Port

QB

### Technical Features

- **Sizes available (Nominal) :** DN8/1/4", DN10/3/8", DN15/1/2", DN20/3/4", DN25/1", DN32/1 1/4", DN40/1 1/2", DN50/2" & DN65/2 1/2"
- **Pressure data :** Working pressure (water) : DN8-DN65 (1/4"- 2 1/2") = 42 bar (600 psi)
- **Finish :** Brass
- **Connections :** Female threaded BSP inlet and outlet

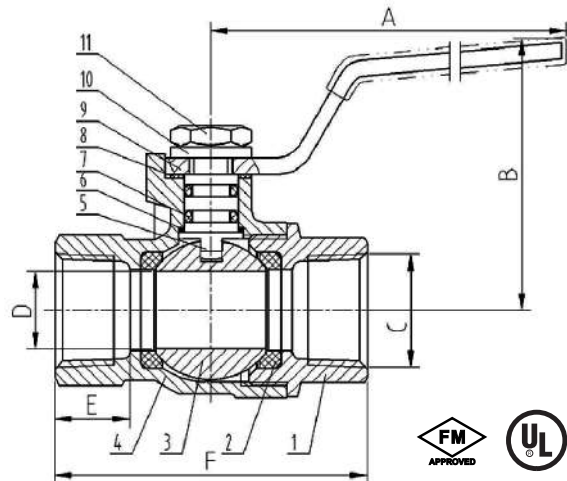

Trim Valves

### Ball Valve (Threaded) Standard Port - QB

Physical Data

Nominal Pipe Size		Dimensions (mm)			Port Size (mm)	Reference	Weight (kg)
Metric	inch	A	B	C			
DN8	1/4"	42	42	60	8	QB2T700-025	0.090
DN10	3/8"	48	47	88	10	QB2T700-037	0.155
DN15	1/2"	57	52	90	14	QB2T700-050	0.216
DN20	3/4"	48	42	90	19	QB2T700-075	0.320
DN25	1"	80	49	115	24	QB2T700-100	0.550
DN32	1 1/4"	93	76	141	31	QB2T700-125	0.780
DN40	1 1/2"	95	80	141	38	QB2T700-150	1.080
DN50	2"	114	90	151	49	QB2T700-200	1.663
DN65	2 1/2"	140	123	211	64	QB2T700-250*	3.719

\* Not UL/FM Approved

### Ball Valve - QB

### Materials List

Item	Description	Material	Specification
1	Adapter	Forged Brass	HPb59-1
2	Seats	PTFE	Commercial
3	Ball	Chromed Brass	HPb59-1 (Chrome)
4	Body	Forged Brass	HPb59-1
5	Stem	Brass	HPb59-1
6	Washer	PTFE	Commercial
7	O-ring	NBR	Commercial
8	Washer	PTFE	Commercial
9	Handle	Steel	Q235A
10	Spring Washer	Spring Steel	65Mn
11	Handle Nut	Steel	Q235A



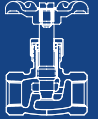

## Angle Valve (Threaded)

### T301W

#### Technical Features

- **Sizes available (Nominal) :** DN32/1<sup>1</sup>/<sub>4</sub>" , DN40/1<sup>1</sup>/<sub>2</sub>" , DN50/2" , DN65/2<sup>1</sup>/<sub>2</sub>" and DN80/3" .
- **Pressure data :**  
Working pressure : 12.1 bar (175 psi)
- **Finish :** Cast Bronze
- **Connections :** Female threaded NPT inlet and outlet.

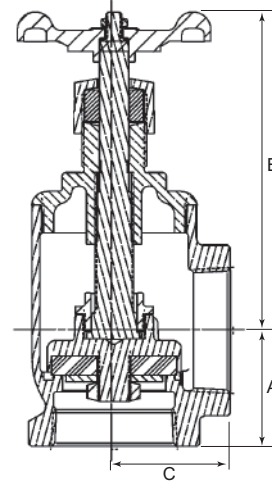

#### Angle Valve (Threaded) - T301W

#### Physical Data

Nominal Pipe Size		Dimensions (mm / inch)			Reference	Weight (kg/lbs)
Metric	inch	A	B (open)	C		
DN32	1 <sup>1</sup> / <sub>4</sub>	56 / 2.19	156 / 6.13	56 / 2.19	T301W125	1.69 / 3.71
DN40	1 <sup>1</sup> / <sub>2</sub>	60 / 2.38	183 / 7.19	60 / 2.38	T301W150	2.52 / 5.54
DN50	2	57 / 2.25	184 / 7.25	57 / 2.25	T301W200	3.05 / 6.72
DN65**	2 <sup>1</sup> / <sub>2</sub> **	81 / 3.19	268 / 10.56	81 / 3.19	T301W250	7.33 / 16.13
DN80**	3**	86 / 3.88	283 / 11.13	86 / 3.88	T301W300	9.87 / 21.72

<sup>1</sup> UL/UL Listed for sizes for trim and drain use 1<sup>1</sup>/<sub>4</sub>" , 1<sup>1</sup>/<sub>2</sub>" and 2" .

\*\* Sizes 2<sup>1</sup>/<sub>2</sub>" and 3" supplied with TFE disc.

#### Angle Valve (Threaded) - T301W

#### Materials List

Item	Description	Material	Specification
1	Handwheel Nut	Stainless Steel	300 Series
2	Identification Plate	Aluminium	
3	Handwheel	Alluminium	Commercial Alloy C38000
4	Stem	Silicon Bronze	ASTM B-371 Alloy C69430
5	Packing Gland	Bronze	ASTM B-62 / ASTM B-16† / ASM B-584 Alloy C84400
6	Packing Nut	Bronze	ASTM B-62 / ASTM B-584 Alloy C84400 / ASTM B-16
7	Packing	Aramid Fibers w/Graphite	Non-Asbestos
8	Bonnet	Bronze	ASTM B-62 Alloy C83600
9	Disc Holder Nut	Bronze	ASTM B-62 Alloy C83600
10	Disc Holder	Bronze	ASTM B-62 Alloy C83600
11	Seat Disc	EPDM Rubber TFE‡	
12	Seat Disc Nut	Bronze	ASTM B-62‡ / ASTM B-96 Alloy C65100 w/SS Washer
13	Body	Bronze	ASTM B-62 Alloy C83600

‡ 2<sup>1</sup>/<sub>2</sub>" and 3" size only.

† Not on 2" .

