

# LP-Gas Technologies

Regulators and Equipment, LPG/ $\text{NH}_3$   
LP-31 Buyer's Guide (2017-2018)



The industry leader for durability and quality.



# Emerson Automation Solutions

## Solving Your Toughest Challenges

Industries are under constant pressure to cut costs, increase output, reduce energy use and improve safety and emissions. That is why companies around the world turn to Emerson Automation Solutions for technologies, services and expertise to solve problems and deliver proven results.



### Expertise and Innovation To Deliver Proven Results

Emerson Automation Solutions is the automation innovator with the depth of expertise and breadth of technologies to take on our customers' toughest challenges and bring predictable success anytime, anywhere.

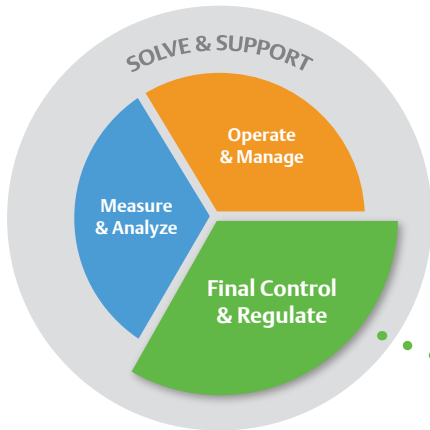

#### Solve and Support

Expertise and global resources to help you dependably define, execute and support a strategy throughout the lifecycle of your operation.

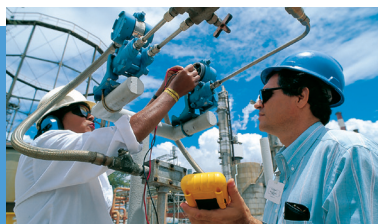

#### Measure & Analyze

The broadest range of measurement and analytical technologies for process clarity and insight.

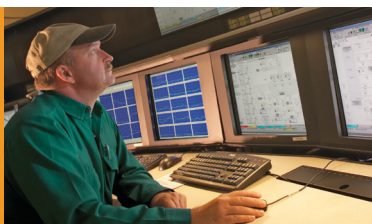

#### Operate & Manage

The systems and tools that provide the decision integrity to run your operation at its full potential.



#### Final Control & Regulate

Highly reliable final control technologies to help you regulate and isolate your process with certainty.



## Control Your System with Certainty

Emerson brings together technology and engineering to provide an expanding array of innovative manufacturing and processing solutions for industrial, commercial and consumer markets. We offer the world's largest collection of pressure control, flow control and relief valve solutions for process and specialty gases, liquids, steam, natural gas and liquid propane industries.

Our regulators are renowned for setting industry standards for performance and extended service life, while Emerson product sales, service and technical support teams are unrivaled in their ability to serve you locally from offices located strategically around the globe.

### Natural Gas Solutions

Emerson leads the way in providing best in-class natural gas conditioning, metering, pressure regulating products and customized skids to the natural gas industry. From regulators to skids, Emerson products offer design innovation, superior performance and unbeatable reliability and durability under extreme conditions in even the world's most rugged environments. Around the clock, around the world, look to Emerson for natural gas solutions.

### LPG Solutions

Throughout the world, Emerson supplies leading liquefied petroleum gas (LPG) suppliers with the broadest available line of Fisher commercial service LPG regulators and bulk storage and transport equipment. Renowned as the propane industry

standard for reliable pressure regulation, Fisher LPG valves and regulators provide high value solutions across a range of stationary storage and mobile applications. With more than 2,000 technical experts at over 200 locations worldwide, our service and support remains second to none.

### Gas, Liquid and Steam Solutions

Emerson offers a dynamic range of Fisher direct and pilot-operated pressure regulators, relief valves and tank management products for industrial gas, liquids and steam applications. Suitable for use in a wide range of environments, from the wellhead to the pharmaceutical plant, their versatility, stability, ease of maintenance and rigorous adherence to ISO-9001 standards for quality and reliability have made them the pressure regulators of choice in tens of thousands of installations worldwide.

## Regulators and Relief Valves



Natural Gas  
Solutions  
Fisher™  
Tartarini™



LPG  
Solutions  
Fisher

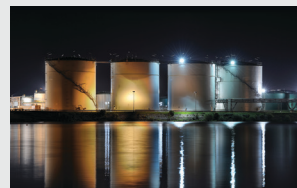

Industrial Gas,  
Liquid & Steam  
Solutions  
Fisher  
Enardo™

[www.Emerson.com](http://www.Emerson.com)

## Quality

Emerson ensures the highest quality and safety standards through our global brands – Fisher™, Tartarini™ and our regional specific brands Enardo™ and Jeon.

For more than a century we have worked side-by-side with customers to understand their challenges and help implement effective solutions. Our systems, processes and employees are committed to providing defect-free products, information and services that satisfy your expectations on time, every time.

Emerson is dedicated to delivering only the highest product quality and performance utilizing efficient operations. We create value by delivering best-in-class pressure and flow control equipment, systems, services and solutions for an unparalleled range of applications. We execute new product development plans with advanced technologies and solutions that deliver undisputed quality.

To achieve consistent operational and product excellence globally we strive to attract the most talented people and support continuous development of our workforce, products and processes at every level.

## Reliability

With more than 125 years of experience, Emerson has built a solid reputation for reliability.

Our regulators, valves and flow control systems are engineered to exacting standards, each carefully designed, thoroughly tested and developed to handle higher pressures while providing increased delivery capacity, reduced noise output and zero emission. We go beyond baseline industry standards to ensure our equipment operates reliably in even the most extreme conditions anywhere in the world.

At Emerson, we are committed to continually raising the bar in our efforts to develop still higher quality, more advanced systems that operate safely and reliably well into the future.

## Technology

Emerson's innovative technologies creates pressure and flow control solutions more productive, efficient and cost-effective. Our proven results are what make us the leader in the industry.

Spanning the globe, our test and evaluation facilities provide the engineering expertise required to ensure superior quality product design and high performance results wherever our products are deployed. At these facilities, we test all sizes and types of regulators under real-world plant conditions to ensure production performance, efficiency, environmental compliance and safety before actual installation at your site.

Our test and evaluation facilities are dedicated to tackling the toughest engineering challenges facing today's process manufacturing and energy industries, including helping companies deliver record volumes of natural gas and other forms of energy, consume less energy, reduce costs, operate more quietly and reduce greenhouse emissions.

## Service

With over 2,000 local technical experts to serve you from nearly 200 locations around the world, our sales and service network is one of the largest in the industry.

Whether you need an emergency replacement regulator or need expert assistance on a long-range growth and expansion plan, there is a local Sales Office to respond quickly and professionally.

## Emerson Automation Solutions Facilities



In 1880, Fisher™ Controls was founded in Marshalltown, Iowa, by William Fisher. Fisher Controls grew steadily over the years, evolving into an industry leader offering customers the most complete range of flow control products in the world.

William Fisher came to America from England as a boy of 14. As his family ventured west in the new land, they settled along the Mississippi in Clinton, Iowa. It was there, as a mechanic in a small engine shop for 10 years, that William learned about steam, the major source of power in the late 1800s. Because of his experience in water and steam, William, who was 24 at the time, was invited to Marshalltown to help install the water works.

The idea of a control device was born in the engineer's mind as a fire raged in the city. Working through the night, William Fisher hand-throttled the steam-driven pumps to maintain pressure in the city's mains. During that fire, he saw a need for a device that would both control the steam-driven pumps and maintain them at a constant pressure. Many months and trials later, William Fisher was finally satisfied with one of his designs and began manufacturing what we know today as the Fisher Type 1 constant pressure pump governor. He was granted a patent in 1884.

One thing remained the same since William Fisher's first Type 1 pump governor: a pledge to unequalled quality. Today, the brand name Fisher is synonymous with quality throughout the world.

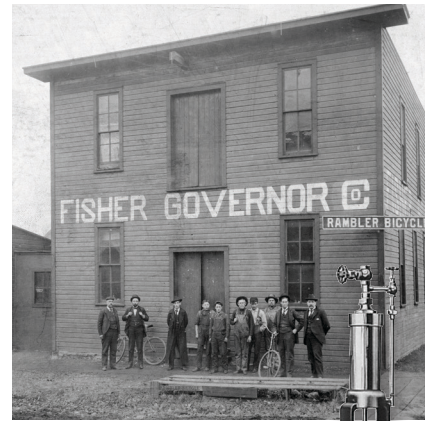

Type 1 Pump Governor 1880

## The Fisher Years

1880 Type 1 pump governor is invented by William Fisher.

1888 The Fisher Governor Company is incorporated on Dec. 26.

1906 William Fisher dies. His wife, Martha, becomes president.

1912 Jasper Fisher assumes presidency; first sales offices are established.

1937 Serial number 500,000 assigned to a Type 1 pump governor on Nov. 5.

1938 Jasper Fisher dies.

1940 First Western Union teletype machine is installed to speed communication.

1943 One millionth serial number assigned June 9.

1944 Mrs. J.H. Fisher is elected president.

1946 Sales department holds first school for field representatives.

1950 Two-millionth controller made. Fisher enters licensee agreement with Elliott Automation to manufacture products for England and Europe.

1954 Mrs. J.H. Fisher retires; J.W. (Bill) Fisher is elected president.

1955 New office building opens in Marshalltown.

1960 Ball valves are added to Fisher's product line. Licensing agreement reached to manufacture in Japan.

1965 Gas regulator department moves to McKinney, Texas.

1967 Governor Road facility, the most advanced machine shop of its kind in the world, begins operation in Marshalltown.

1969 Fisher begins manufacturing electronic instrumentation. Bill Fisher remains as Chairman of the Board until 1974.

1970 Our first European facility opens at Cornwall, England, to manufacture electronic instrumentation.

1972 The R.A. Engel Technical Center, Marshalltown, is completed, housing the world's most advanced flow test laboratory.

1975 A new electronics manufacturing facility is opened in Marshalltown.

1976 Production of our new line of rotary valves begins in Sherman, Texas. Fisher Brazil opens its doors.

1979 Fisher Controls Corporation of Delaware forms a stronger manufacturing, sales and service organization.

1980 Fisher celebrates a Century of Control.

1992 ISO 9001 original registration validated, McKinney, Texas

## The Emerson Years

1993 Fisher Controls and Rosemount, merge under ownership of Emerson Electric.

1994 Francel™, Gallardon, France, acquired, expanding manufacturing and distribution in Europe, Middle East and Africa.

1996 Type 299 pilot-operated regulator introduced to natural gas market.

1997 The 50th anniversary of the Type 99. The FloBoss™ 503 and Regulator Vault are introduced.

1998 Fisher Regulators FROMEX manufacturing plant opens in Nuevo Laredo, Mexico.

1999 Revolutionary Type EZR pressure regulator introduced.

2001 Tartarini™, Bologna, Italy, acquired, extending Fisher's brand and distribution capability in Europe and Asia.

2003 Manufacturing capability expanded with opening of Shanghai Plant.

2003 New, state-of-the-art flow test laboratory opens in McKinney, Texas.

2004 Introduced digitally controlled odorant injection system.

2004 Jeon, Chengdu, China, acquired, expanding Fisher's presence in China's low-pressure regulator market.

2005 Fisher celebrates its 125th anniversary.

2005 EZ Family product lines, Types EZR, EZH and EZL pressure regulators expanded.

2005 Customer Center opened to display new regulator technology and train customers and sales channel.

2005 Tescom™ Corporation, Elk River, Minnesota and Selmsdorf, Germany, manufacturer of high-pressure, high-purity pressure regulators, acquired.

2006 Type SR stainless steel Sanitary Regulator introduced.

2007 Commercial Service Regulators platform introduced featuring True Monitor™ Protection, Slam-Shut and Secondary Seat™ Protection options.

2007 Cluj, Romania, manufacturing location online.

2008 Regulator Division becomes Emerson Process Management Regulator Technologies, Inc.

2013 Enardo™, Tulsa, Oklahoma, acquired, expands Fisher's storage tank solutions for oil and gas, petrochemical and chemical industries.

2014 New Global Regulator Technologies Headquarters opens in McKinney, Texas.

2015 Type CS804 regulator with integral slam-shut is added to CS800 Series.

2015 New product launches for MR95 and MR98 Series.

2015 Emerson celebrates its 125th year anniversary.

2017 Valves & Controls business acquired from Pentair, expands the portfolio of final control products.

# You Demand High Performance. We Ensure It.



## Real-World Simulation

### Flow Testing

- Simulates real-world operating conditions using pipelines up to NPS 32 / DN 800 with compressible and incompressible fluids up to 30,000 psig / 2068 bar
- Ensures product performance, efficiency, environmental compliance, life span and safety

### Materials Testing

- Develops and tests materials to improve regulator performance and reliability
- Ensures materials meet customer requirements, national standards, and our own, still higher, brand standards
- Analyzes and troubleshoots field installations for contamination and composition at an elemental level

### Environmental Testing

- Simulates real-world operating conditions from the deserts of the Middle East to the Arctic North
- Validates product lifecycles at field conditions to extend service life
- Verifies product corrosion resistance using extended salt-spray exposure to ensure environmental protection of process equipment

You demand products to withstand your toughest conditions, while delivering continued optimal performance, efficiency, reliability and safety.

Our design, test and evaluation technologies and techniques validate a full range of product offerings in each of these critical areas, providing flow, material and environmental testing under real-world operating conditions before you place them in your application.

With more than 130 years of application experience in the process industry, our reputation for solving challenging problems and developing products to specifications exceeding regulatory guidelines. Count on Emerson worldwide to deliver the highest quality products available to your site.



EMERSON. CONSIDER IT SOLVED.™

REGULATOR APPLICATION MAP .....	2	<b>VALVES</b>	
VALVE APPLICATION MAP .....	4	INTERNAL VALVES .....	46
REGULATOR SELECTION GUIDE .....	9	Types C404-32, C407-10, C471, C477, C483, C484 and C486	
VALVE SELECTION GUIDE .....	14	Types C804-32, C807-10, C871, C877, C883, C884, C897 and C891	
ACCESSORIES SELECTION GUIDE .....	19	INTERNAL VALVE ACCESSORIES .....	60
<b>REGULATORS</b>		P600 Series Brake Chamber Actuators	
TWO-STAGE SYSTEMS .....	24	P700 Series Rotary Actuators	
FIRST-STAGE REGULATORS .....	25	EMERGENCY SHUTOFF VALVES .....	62
Types R122H, R222H and R622H		Types N551, N562 and N563	
SECOND-STAGE REGULATORS .....	26	Types N851, N862 and N863	
Types HSRL, R222, R622, R642 and R652		EXCESS FLOW VALVES .....	66
Two-psi SERVICE REGULATORS .....	27	Types F100, F130, F170, F190 and F202	
Types R622E and R652E		RELIEF VALVES .....	67
INTEGRAL TWO-STAGE REGULATORS .....	28	Types H110, H120, H123, H124, H125, H144, H148, H150,	
Types R232A and R632A		H173, H174, H185, H284, H722, H733, H5114 and 63EGLP Series	
INTEGRAL TWO-PSI REGULATORS .....	29	GLOBE AND ANGLE VALVES .....	71
Types R232E and R632E		Types N301, N310, N310F, N350, N401, N410, N410F and N450	
COMMERCIAL/INDUSTRIAL		Types N801, N810, N810F, N901, N910 and N910F	
HIGH-PRESSURE REGULATORS .....	30	BACK CHECK VALVES .....	72
Types 67CW, 67CH, 67CD, 67CN, 64, 64SR, 627, 630, 99		Types G100, G101, G102, G104, G105, G106, G107,	
and 1098-EGR		G109, G112, G200 and G201	
COMMERCIAL LOW-PRESSURE REGULATORS .....	36	HOSE END, FILLER AND LIQUID TRANSFER VALVES .....	73
Types CS200, CS400, CS800, 133L, 133H, 299H and 99L		Types D138, D139, D140, D141, M455, N456,	
COMMERCIAL SERVICE OVERPRESSURE PROTECTION .....	38	N480 and N481	
Types CS403, CS404 and CS803		BYPASS AND BACKPRESSURE VALVES .....	74
AUTOMATIC CHANGEOVER REGULATORS .....	41	Types N100, N110 and N120	
Types 64SR, 749B, 803 and R130		LIQUID LEVEL INDICATORS .....	76
MONITOR OVERPRESSURE PROTECTION .....	42	Types J-31, J402S, J403S, J415, J415-1 and J700	
Types 627M, 99M and 1098		COUPLINGS AND ADAPTORS .....	77
BACKPRESSURE REGULATORS/RELIEF VALVES .....	43	M Series, Types P174 and P104-24	
Types MR98H, 289H, 1805 and 1808		MISCELLANEOUS EQUIPMENT .....	80
REGULATOR ACCESSORIES .....	44	COMPLIANCE SYSTEMS .....	82
		CONVERSION FACTORS .....	83
		PRODUCTS LISTING .....	84
		PILOTS AND REPAIR KITS LISTING .....	108
		INDEX .....	111

Where applicable, Fisher™ brand products presented in this catalog are listed by Underwriters Laboratories (UL®). Use of these products may provide compliance with standards developed by the National Fire Protection Association's Pamphlets 54 and 58. They may also assist in meeting guidelines established by the Department of Transportation, ASME and other third party agencies. Contact your Fisher brand LPG Regulators and Equipment Distributor for assistance in determining product applications.



# Application: Regulators

FISHER™

R642  
Second-  
Stage



67CW  
High-  
Pressure



R622  
Second-  
Stage



R622H  
First-  
Stage



R222  
Second-  
Stage



R222H  
First-  
Stage



R652  
Second-  
Stage



R122H  
First-  
Stage



99  
First-  
Stage



299H  
Second-  
Stage



1098  
First-  
Stage



## Features

- Corrosion-Resistant and Wear-Resistant Materials
- Stainless Steel Inlet Screen
- Large Drip-Lip Vent
- High Capacity Relief
- Easy Installation
- Improved Regulation
- Built-in Gauge Taps

EMERSON



**Introduction**

The regulator truly is the heart of an LPG installation. It must compensate for variations in tank pressure from 8 to 250 psig / 0.55 to 17.2 bar and deliver a constant outlet pressure of LPG typically at 11 in. w.c. / 27 mbar to consuming appliances. The regulator must deliver this pressure despite the intermittent use of the appliances.

In propane service, NFPA 58 requires Two-Stage regulation on all fixed piping systems that serve

14 in. w.c. / 35 mbar appliance systems (normally operated at 11 in. w.c. / 27 mbar pressure). Two-Stage regulation produces a nearly constant pressure to the appliance and can result in a more efficient LPG operation for the dealer resulting in less maintenance and fewer installation call-backs.

With properly selected regulators, the internal relief valve provides 2 psig / 0.14 bar overpressure protection as required by NFPA 58.

Emerson is a leading international supplier of cost-effective products, services and solutions used in the propane industry. Around the world, Emerson and its distributors offer quality products as well as applications engineering, education programs and after sales service. For any of the products described in this catalog, contact the Fisher™ LPG Equipment distributor near you.

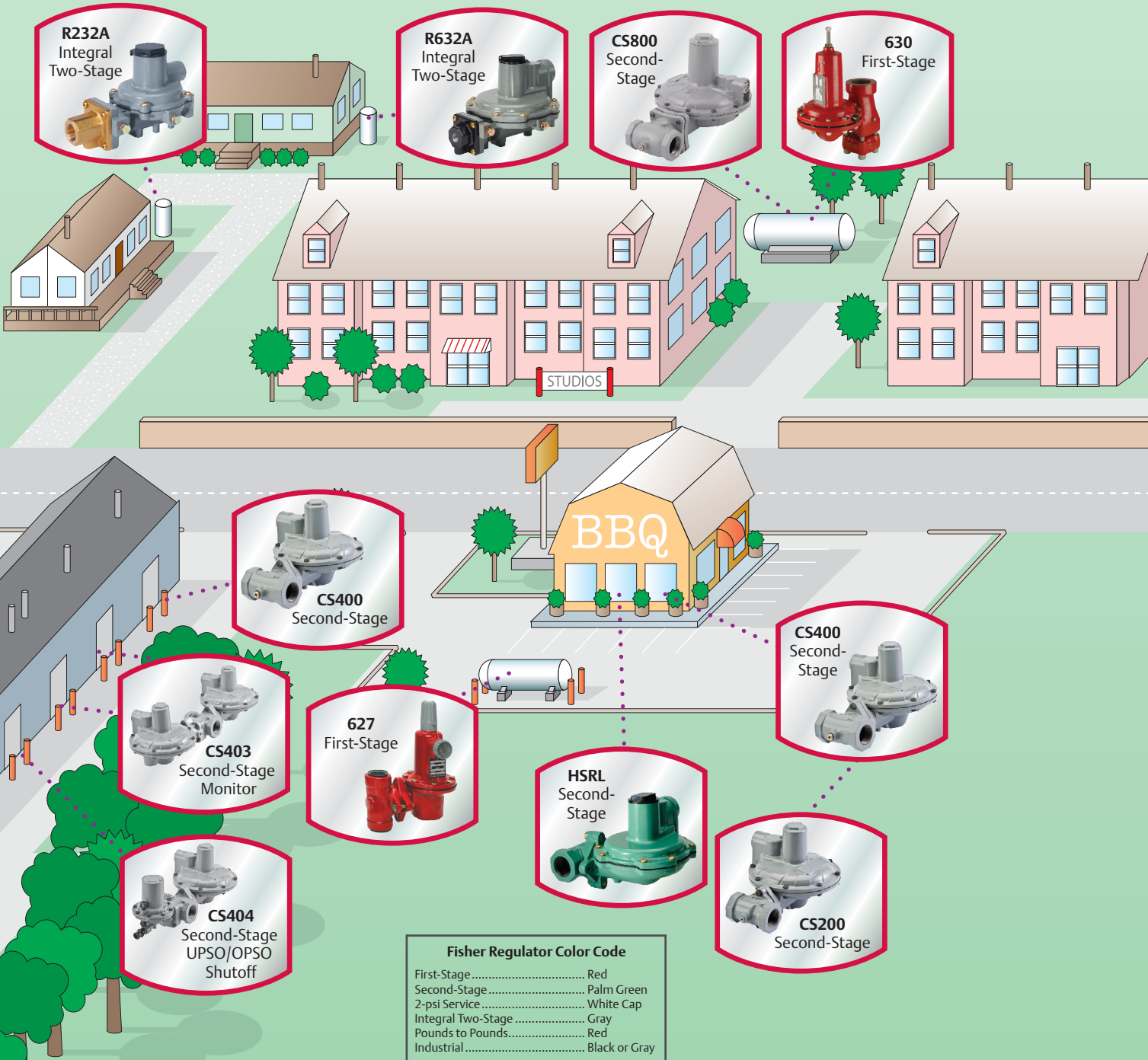

# Application: Valves and Relief Valves

FISHER™

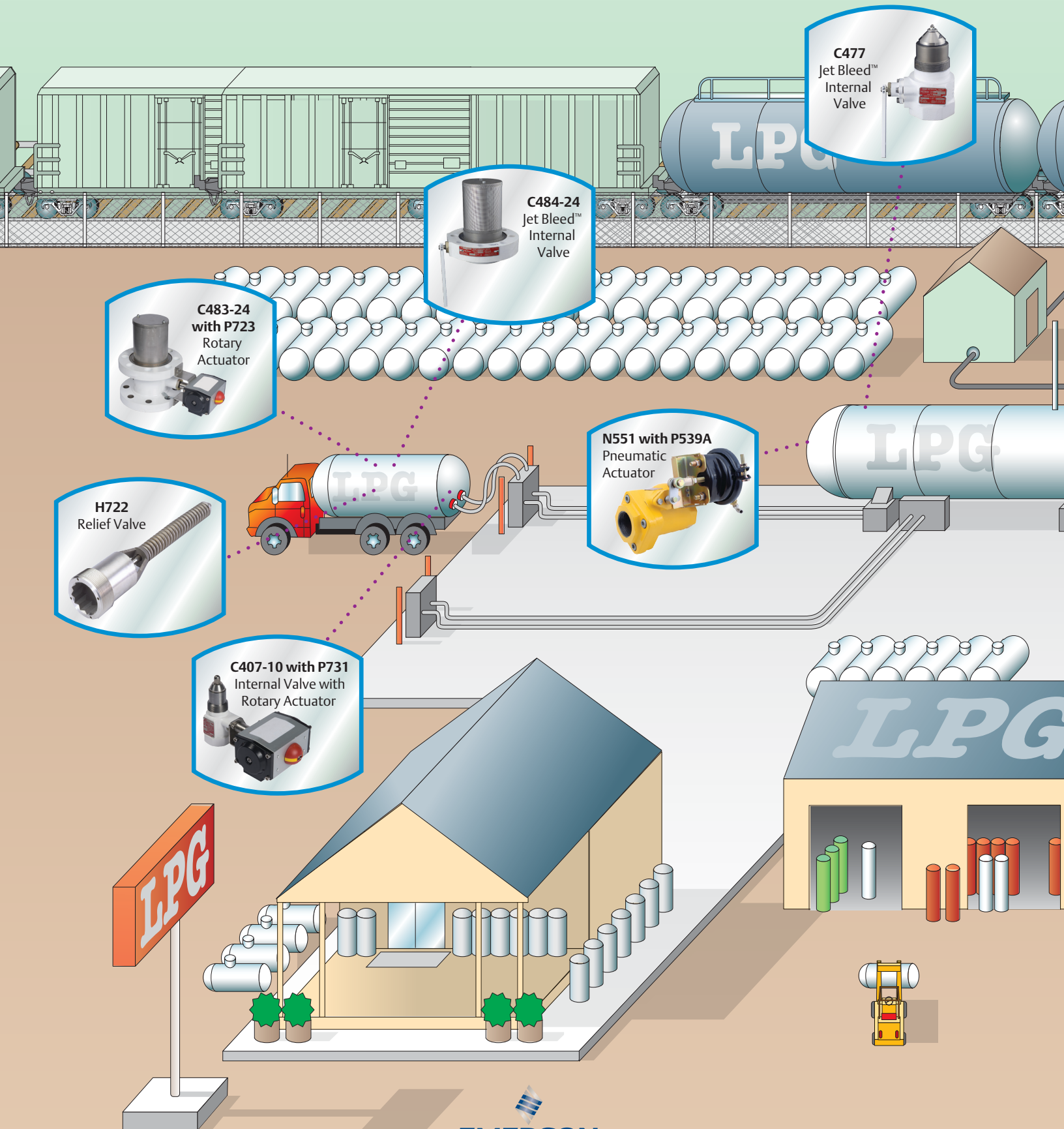

**Introduction**

Fisher™ brand internal valves, relief valves, emergency shutoff valves and globe and angle valves are installed in the inlets and outlets (liquid or vapor) of pressure vessels and in piping systems to control the flow of LPG and Anhydrous Ammonia (NH<sub>3</sub>). These valves are frequently used on bobtails, transport truck tanks, large stationary storage tanks and in-line installations.

The valves provide a means of withdrawing and filling product with or without pumps and compressors. These valves may be used as primary shutoff valves, excess flow valves and back check valves. No one offers a more complete line of LPG Equipment to match your job specification.

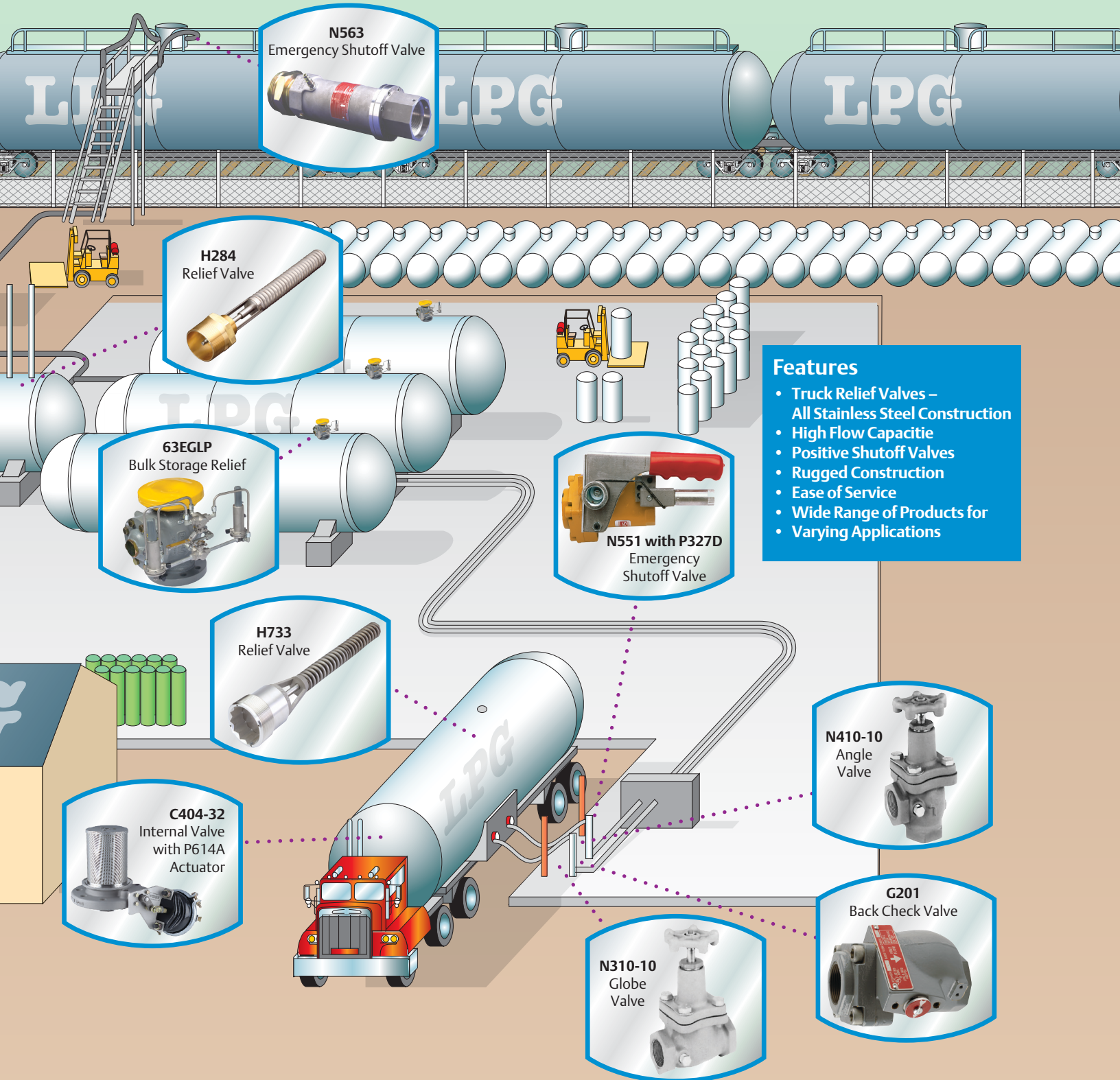

**N563**  
Emergency Shutoff Valve

**H284**  
Relief Valve

**63EGLP**  
Bulk Storage Relief

**H733**  
Relief Valve

**C404-32**  
Internal Valve  
with P614A  
Actuator

**N551 with P327D**  
Emergency  
Shutoff Valve

**N410-10**  
Angle  
Valve

**N310-10**  
Globe  
Valve

**G201**  
Back Check Valve

- Features**
- Truck Relief Valves – All Stainless Steel Construction
  - High Flow Capacitie
  - Positive Shutoff Valves
  - Rugged Construction
  - Ease of Service
  - Wide Range of Products for
  - Varying Applications

# Application: Bobtail Application Map

FISHER™

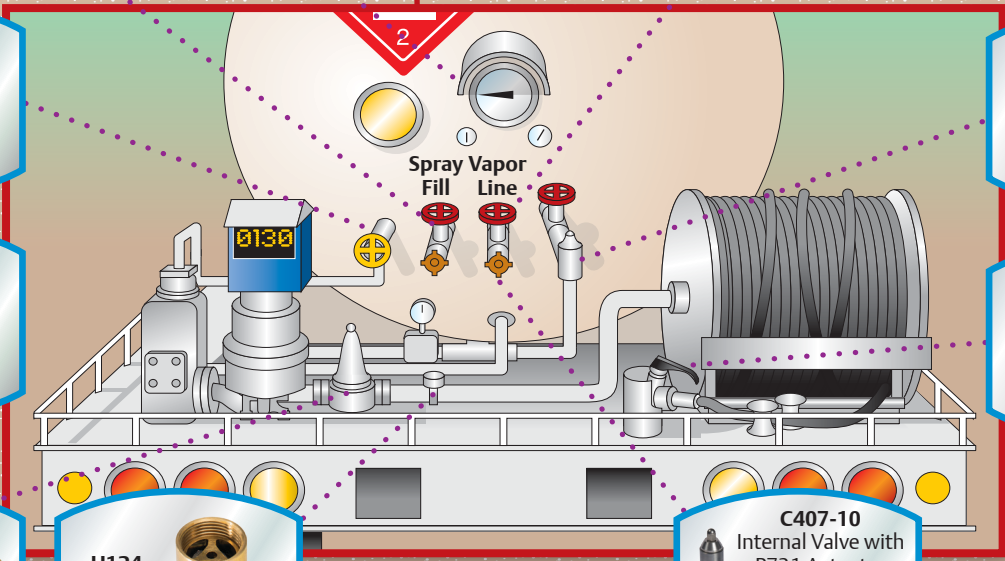
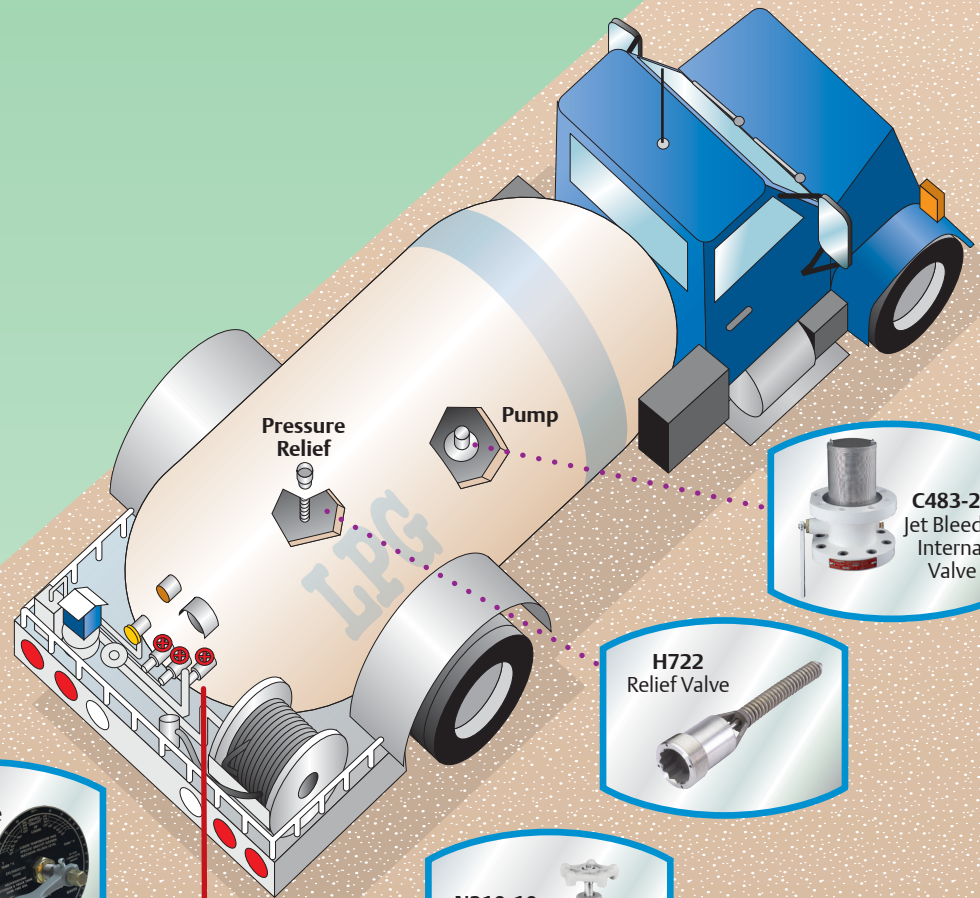

# Application: Transport Application Map

FISHER

## Features

- Rugged Designs
- All Stainless Steel Construction
- Long Life Sealants
- Ease of Maintenance
- Wide Selection of Products and Accessories

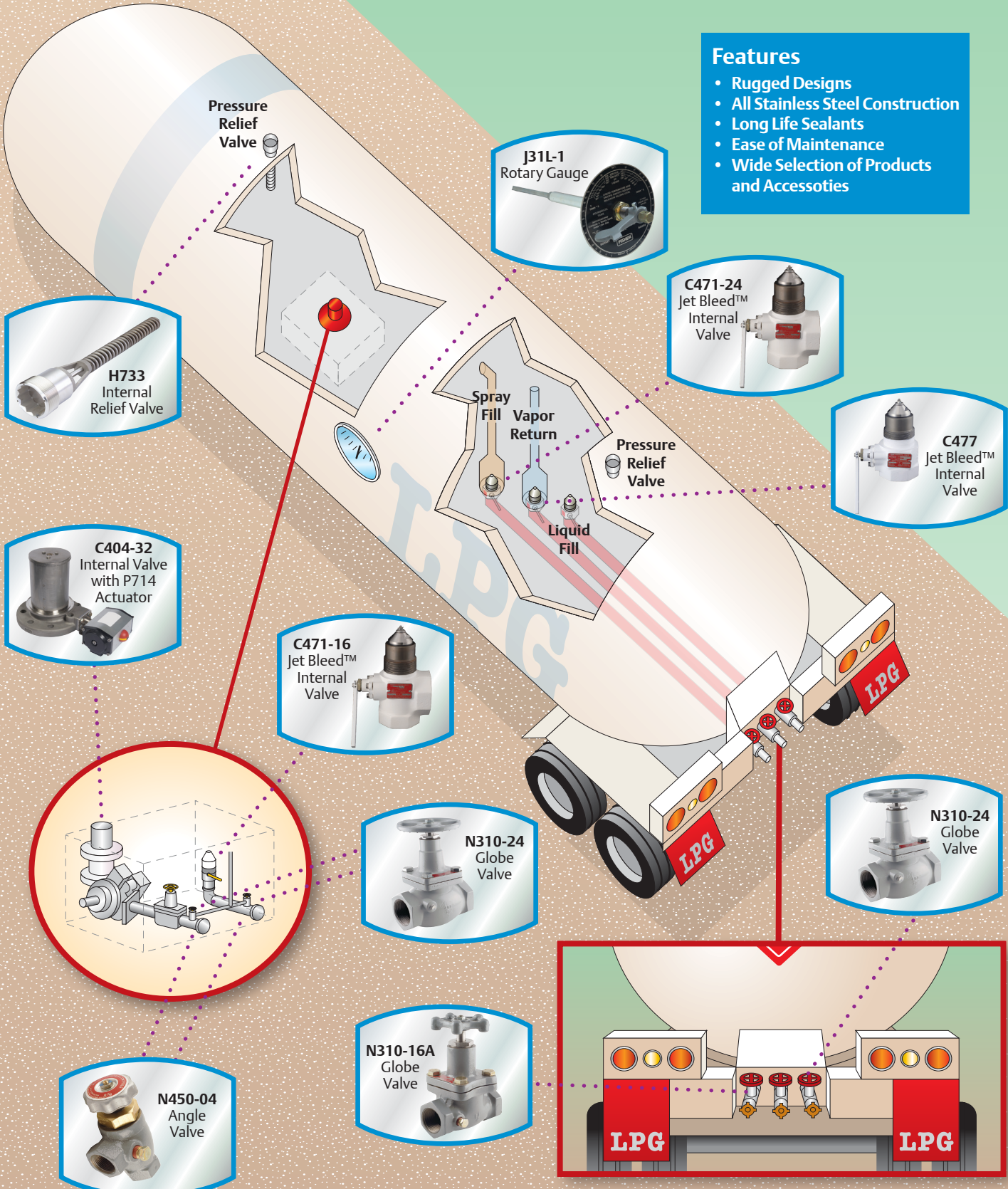

# Application: Bobtail Application Map

FISHER™

## Features

- High Flow Capacity
- Rugged Designs
- Easy Maintenance
- Wide Selection of Products and Accessories

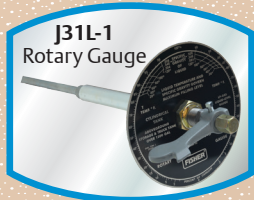







Hoses to truck

LIQUID LINE

VAPOR LINE

**Commercial/Industrial High-Pressure Regulators**

Maximum Inlet Pressure	Outlet Pressure Range	Rated Capacity* <sup>(1)</sup>		Type Number
250 psig / 17.2 bar	3 to 120 psig / 0.21 to 8.3 bar	1.2M BTU per hour / 13.5 SCMH		<b>67C Series</b> Page 30
250 psig / 17.2 bar	3 to 100 psig / 0.21 to 6.9 bar	5.25M BTU per hour / 59.1 SCMH		<b>64 Series</b> Page 31
250 psig / 17.2 bar	5 to 40 psig / 0.35 to 2.8 bar	20.95M BTU per hour / 235 SCMH		<b>627 Series</b> Page 32
250 psig / 17.2 bar	8 to 20 psig / 0.55 to 1.4 bar	14M BTU per hour / 158 SCMH		<b>630 Series</b> Page 33
300 psig / 20.7 bar	7 in. w.c. to 65 psig / 17 mbar to 4.5 bar	74.3M BTU per hour / 836 SCMH		<b>99 Series</b> Page 34
400 psig / 27.6 bar	3 to 100 psig / 0.21 to 6.9 bar	1.2B BTU per hour / 13,481 SCMH		<b>1098 Series</b> Page 35

\*See capacity tables in the following sections for expanded rating information.  
1. Based on inlet pressure 20 psig / 1.4 bar greater than outlet with 20% droop, unless otherwise noted.



## Commercial/Industrial Low-Pressure Regulators

Maximum Inlet Pressure	Outlet Pressure Range	Rated Capacity* <sup>(1)</sup>		Type Number
125 psig / 8.6 bar	3.5 in. w.c. to 2 psig / 9 mbar to 0.14 bar	3.9M BTU per hour / 43.8 SCM <sup>H</sup> <sup>(3)</sup>		<b>CS200 Series</b> Page 36
125 psig / 8.6 bar	3.5 in. w.c. to 5.5 psig / 9 mbar to 0.38 bar	8.9M BTU per hour / 100 SCM <sup>H</sup> <sup>(2)</sup>		<b>CS400 Series</b> Page 36
125 psig / 8.6 bar	8 in. w.c. to 5.5 psig / 20 mbar to 0.38 bar	20M BTU per hour / 224 SCM <sup>H</sup>		<b>CS800 Series</b> Page 36
60 psig / 4.1 bar	1.5 to 3 psig / 0.10 to 0.21 bar	66.15M BTU per hour / 745 SCM <sup>H</sup> <sup>(2)</sup>		<b>Type 133H</b> Page 40
60 psig / 4.1 bar	8.5 to 18 in. w.c. / 21 to 45 mbar	70.8M BTU per hour / 797 SCM <sup>H</sup> <sup>(3)</sup>		<b>Type 133L</b> Page 40
150 psig / 10.3 bar	9 in. w.c. to 16 psig / 22 mbar to 1.1 bar	38M BTU per hour / 428 SCM <sup>H</sup>		<b>299H Series</b> Page 40
150 psig / 10.3 bar	7 in. w.c. to 5 psig / 18 mbar to 0.35 bar	63.25M BTU per hour / 712 SCM <sup>H</sup>		<b>99-500P Series</b> Page 40
250 psig / 17.2 bar	3 in. w.c. to 5 psig / 7 mbar to 0.35 bar	556,000 BTU per hour / 6.2 SCM <sup>H</sup> <sup>(4)</sup>		<b>912 Series</b> Page 44





\*See capacity tables in the following sections for expanded rating information.  
 1. Based on inlet pressure 20 psig / 1.4 bar greater than outlet with 20% droop, unless otherwise noted.  
 2. Based on 10 psig / 0.69 bar inlet pressure setting and 20% droop.  
 3. Based on 10 psig / 0.69 bar inlet pressure setting and 2 in. w.c. / 5 mbar droop.  
 4. Types 912-101 and -104 rating at 30 psig / 2.1 bar inlet.



**First-Stage Regulators**



Maximum Inlet Pressure	Outlet Pressure Setting/Setpoint	Rated Capacity* <sup>(1)</sup>	Type Number
250 psig / 17.2 bar	10 psig / 0.69 bar +/- 1 psig / 69 mbar nominal outlet setting (non-adjustable)	1.1M BTU per hour / 12.4 SCMH	 <b>R122H Series</b> Page 25
250 psig / 17.2 bar	5 or 10 psig / 0.35 or 0.69 bar standard setpoints	2.0M BTU per hour / 22.5 SCMH	 <b>R222H Series</b> Page 25
250 psig / 17.2 bar	5 or 10 psig / 0.35 or 0.69 bar standard setpoints	2.4M BTU per hour / 27.0 SCMH	 <b>R622H Series</b> Page 25

**Second-Stage Regulators<sup>(3)</sup>**



Maximum Inlet Pressure	Outlet Pressure Range	Rated Capacity* <sup>(2)</sup>	Type Number
10 psig / 0.69 bar	9 to 13 in. w.c. / 22 to 32 mbar	2.6M BTU per hour / 29.3 SCMH	 <b>Type HSRL</b> Page 26
10 psig / 0.69 bar	11 in. w.c. / 27 mbar	650,000 BTU per hour / 7.3 SCMH	 <b>R222 Series</b> Page 26
10 psig / 0.69 bar	11 in. w.c. / 27 mbar	1.4M BTU per hour / 15.8 SCMH	 <b>R622 Series</b> Page 26
10 psig / 0.69 bar	11 in. w.c. / 27 mbar	920,000 BTU per hour / 10.4 SCMH	 <b>R642 Series</b> Page 26
10 psig / 0.69 bar	11 in. w.c. / 27 mbar	1M BTU per hour / 11.2 SCMH	 <b>R652 Series</b> Page 26

\*See capacity tables in the following sections for expanded rating information.  
 1. Based on 30 psig / 2.1 bar inlet pressure and 20% droop.  
 2. Based on 10 psig / 0.69 bar inlet pressure setting.  
 3. Second-Stage regulators are UL® rated.

## 2-psi Service Regulators



Maximum Inlet Pressure	Standard Setpoint	Rated Capacity* <sup>(1)</sup>		Type Number
10 psig / 0.69 bar	2 psi / 0.14 bar	1.68M BTU per hour / 18.9 SCMh		<b>R622E Series</b> Page 27
10 psig / 0.69 bar	2 psi / 0.14 bar	1.5M BTU per hour / 16.9 SCMh		<b>R652E Series</b> Page 27

## Integral Two-Stage Regulators



Maximum Inlet Pressure	Standard Setpoint	Rated Capacity* <sup>(1)</sup>		Type Number
250 psig / 17.2 bar	<b>First-Stage:</b> Approximately 10 psig / 0.69 bar (non-adjustable)  <b>Second-Stage:</b> 11 in. w.c. / 27 mbar	550,000 BTU per hour / 6.2 SCMh		<b>R232A Series</b> Page 28
250 psig / 17.2 bar	<b>First-Stage:</b> Approximately 10 psig / 0.69 bar (non-adjustable)  <b>Second-Stage:</b> 11 in. w.c. / 27 mbar	950,000 BTU per hour / 10.7 SCMh		<b>R632A Series</b> Page 28

\*See capacity tables in the following sections for expanded rating information.  
1. Based on 10 psig / 0.69 bar inlet pressure setting and 20% droop.  
2. Based on 30 psig / 2.1 bar inlet pressure setting and 2 in. w.c. / 5 mbar droop.

### Integral Two-psig Regulators

Maximum Inlet Pressure	Standard Setpoint	Rated Capacity* <sup>(1)</sup>		Type Number
250 psig / 17.2 bar	<b>First-Stage:</b> Approximately 10 psig / 0.69 bar (non-adjustable)  <b>Second-Stage:</b> 2 psi / 0.14 bar	500,000 BTU per hour / 5.6 SCMH		<b>R232E Series</b> Page 29
250 psig / 17.2 bar	<b>First-Stage:</b> Approximately 10 psig / 0.69 bar (non-adjustable)  <b>Second-Stage:</b> 2 psi / 0.14 bar	900,000 BTU per hour / 10.1 SCMH		<b>R632E Series</b> Page 29

### Backpressure Regulators/Relief Valves

Maximum Working Pressure	Relief Pressure Setting	Rated Capacity*		Type Number
300 psig / 20.7 bar	100 psig / 6.9 bar	93.1 GPM / 352 l/min Propane		<b>Type MR98H</b> Page 43
25 psig / 1.7 bar	15 psig / 1.0 bar	20,000 SCFH / 566 SCMH Propane		<b>Type 289H</b> Page 43
150 psig / 10.3 bar	30 psig / 2.1 bar	12,000 SCFH / 340 SCMH Propane		<b>Type 1805</b> Page 43

\*See capacity tables in the following sections for expanded rating information.  
1. Based on 30 psig / 2.1 bar inlet pressure setting and 20% droop.

### Internal/External Relief Valves

Maximum Inlet Pressure (Body Rating)	Standard Setpoint	Capacity*		Type Number
480 psig / 33.1 bar	85 to 375 psig / 5.9 to 26 bar	Up to 47,164 SCFM / 84,170 SCM <sub>H</sub>		<b>Type 63EGLP</b> Page 69
480 psig / 33.1 bar	125 to 312 psig / 8.6 to 21.5 bar	<b>UL®:</b> Up to 11,635 SCFM / 20,764 SCM <sub>H</sub> Air  <b>ASME:</b> Up to 15,286 SCFM / 18,097 SCM <sub>H</sub> Air		<b>H284 and H5114 Series</b> Page 68
480 psig / 33.1 bar	125 to 312 psig / 8.6 to 21.5 bar	<b>UL:</b> Up to 11,315 SCFM / 19,940 SCM <sub>H</sub> Air  <b>ASME:</b> Up to 13,876 SCFM / 16,400 SCM <sub>H</sub> Air		<b>H722 and H733 Series</b> Page 67
420 psig / 29.0 bar	35 to 350 psig / 2.4 to 23.8 bar Fixed Setting	Up to 2456 SCFM / 4173 SCM <sub>H</sub>		<b>H100 Series</b> Page 70

### Bypass and Backpressure Valves

Maximum Working Pressure	Relief Pressure Range	Body Size and End Connection Style		Type Number
400 psig / 27.6 bar	10 to 150 psig / 0.69 to 10.3 bar	3/4 to 2 in. FNPT		<b>N100 Series</b> Page 74



\*See capacity tables in the following sections for expanded rating information.

## Internal Valves

Pressure Rating	Excess Flow Spring	Capacity*		Type Number
400 psig / 27.6 bar WOG	30 to 80 GPM / 113 to 302 l/min	19,200 SCFH / 544 SCMH Propane		<b>C407-10 Series</b> Page 47
400 psig / 27.6 bar WOG	60 to 460 GPM / 227 to 1741 l/min	178,000 SCFH / 5040 SCMH Propane		<b>C471-16, -24 Jet Bleed Internal™ Series</b> Page 47
400 psig / 27.6 bar WOG	100 to 460 GPM / 379 to 1741 l/min	178,000 SCFH / 5040 SCMH Propane		<b>C477-16, -24 and C486-24 Jet Bleed Internal™ Series</b> Page 47
400 psig / 27.6 bar WOG	160 to 400 GPM / 606 to 1514 l/min	190,000 SCFH / 5380 SCMH Propane		<b>C483-24 Jet Bleed Internal™ Series</b> Page 53
400 psig / 27.6 bar WOG	160 to 400 GPM / 606 to 1514 l/min	190,000 SCFH / 5380 SCMH Propane		<b>C484-24 Jet Bleed Internal™ Series</b> Page 53
400 psig / 27.6 bar WOG	340 to 1000 GPM / 1287 to 3785 l/min	356,200 SCFH / 10,088 SCMH		<b>Type C404-32</b> Page 55

\*See capacity tables in the following sections for expanded rating information.

### Back Check Valves

Seat Construction	Pressure Rating	Capacity*		Type Number
Soft Seat and Metal Seat	250 psi / 17.2 bar	254 GPM / 961 l/min Propane		<b>G100 Series</b> Page 72
Soft Seat	400 psig / 27.6 bar WOG	Up to 1620 GPM / 6132 l/min Propane		<b>G200 Series</b> Page 72

### Emergency Shutoff Valves

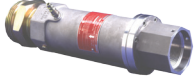
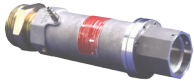



Body Size and End Connection Style	Maximum Inlet Pressure	Capacity*		Type Number
1-1/4, 2 or 3 in. FNPT	400 psig / 27.6 bar	Up to 850 GPM / 3127 l/min Propane		<b>N551 Series</b> Page 62
2 in. FNPT	400 psig / 27.6 bar	200 GPM / 757 l/min Propane		<b>N562 Series</b> Page 64
2 in. FNPT	400 psig / 27.6 bar	413 GPM / 1563 l/min Propane		<b>N563 Series</b> Page 64

\*See capacity tables in the following sections for expanded rating information.

## Globe and Angle Valves

Selection Description	Maximum Operating Pressure	Body Size and End Connection Style		Type Number
Globe Valve (Heavy Duty Version)	400 psig / 27.6 bar	1/2 to 3 in. FNPT and 3 in. / DN 80 CL300 RF Flange	<b>N301, N310 Series</b> Page 71	
Globe Valve (Economy Duty Version)	400 psig / 27.6 bar	1/2 to 3/4 in. FNPT	<b>N350 Series</b> Page 71	
Angle Valve (Heavy Duty Version)	400 psig / 27.6 bar	1/2 to 3 in. FNPT and 3 in. / DN 80 CL300 RF Flanged	<b>N401, N410 Series</b> Page 71	
Angle Valve (Heavy Duty Version)	400 psig / 27.6 bar	1/2 to 3/4 in. FNPT	<b>N450 Series</b> Page 71	

\*See capacity tables in the following sections for expanded rating information.

Valves			
Product/Function	Selection Information		Type Number
Excess Flow Valve	Brass or Steel body in a variety of Inlet and Outlet Connection Sizes and Styles; Up to 10.7 psi / 0.74 bar differential pressure		<b>F Series</b> Page 66
Filler Valve	2 in. MNPT x 2-1/4 in. ACME or 3 in. MNPT x 3-1/4 in. ACME; Single or Double Back Check style; 275 GPM / 1041 l/min filling capacity		<b>D Series</b> Page 73
Hose End Valve	1-3/4 in. ACME x 1 in. NPT; Ductile iron body		<b>Type N480</b> Page 73
Liquid Transfer Valve	3/4 MNPT x 1-3/4 in. Male ACME		<b>N456 Series</b> Page 73
Cylinder Filling Valve	30 psig / 2.1 bar Recommended Supply Pressure; Aluminum Body		<b>Type N201</b> Page 81

\*See capacity tables in the following sections for expanded rating information.



**Regulator Accessories**

Product/Function	Selection Information		Type Number
Screened Vents for Regulator	1/4 in. FNPT to 1 in. MNPT		<b>Y602 Series</b> Page 44
Regulator Mounting Brackets	Triangular, Bowtie or Strap Design		<b>Type P100</b> Page 45
Test Pressure Gauge for Appliance Line Pressure	1/4 in. NPT or Female Hose		<b>50 Series</b> Page 45
Pressure Gauge	1/4 in. MNPT; 0 to 400 psi / 0 to 27.6 bar; Ranges in MPa, kg/cm2, bar		<b>J500 Series</b> Page 45
Adjustable Orifice Reamer	Drill Size No. 80 through No. 50		<b>Type P520L</b> Page 81

### Bulk Storage Tank and Valve Accessories

Product/Function	Selection Information		Type Number
Rotary Level Gauge for Stational or Mobile Tank	68 to 140 in. / 1727 to 3556 mm Lengths		<b>Type J-31</b> Page 76
Liquid Level Vent Valves	3/4 in. MNPT for FNPT Connection; with or without Pressure Gauge		<b>J400 Series</b> Page 76
Container (Tank) Thermometer	1/2 in. MNPT; -40 to 120°F / -40 to 49°C		<b>J700 Series</b> Page 76
Female Acme Filler Couplings	1-3/4 in. Female Acme by 1/2 in. MNPT through 4-1/4 in. Female Acme by 3 in. MNPT		<b>Type M631</b> Page 77
Female Acme Vapor Return Couplings	1-3/4 in. Female Acme by 3/4 in. MNPT through 2-1/4 in. Female Acme by 1-1/4 in. MNPT		<b>Types M151, M160</b> Page 77
O-ring for Male Adaptors	For 2-1/4 or 3-1/4 in. Adaptors to Give a Better Seal than Washers		<b>T12655T0012 / 1H291706562</b> Page 76
Adaptor Caps	2-1/4 through 4-1/4 in. Female Acme by 1-3/4 through 3-1/4 in. Male Acme		<b>Type M611</b> Page 76
POL Filler Coupling	Soft-Nose Male POL by 1/4 in. MNPT		<b>Type M390</b> Page 77
Filler Valve Adaptor	For Filler Valves with 1-3/4 in. Male Acme Filler Connection and a 3/4 in. FNPT Outlet		<b>Type M450A</b> Page 78

**Bulk Storage Tank and Valve Accessories**

Product/Function	Selection Information		Type Number
Swivel POL Adaptor with Metal Seats	Straight or Angle Male POL by 1/4 in. MNPT		<b>Type M318</b>
Auxiliary Remote Cable Release for Internal Valves	With 25 or 50-Foot / 7.6 or 15.2 m Cable or without Cable		<b>Type P163A</b> Page 76
Handle- or Cable-Operated Latch/ Remote Release for Internal Valves	Built-In Fusible Link to Close Valve in Case of Fire		<b>Type P313</b> Page 76
Primary Cable Control for Internal Valves	4, 5 or 6 in. / 102, 137 or 152 mm Travel		<b>Type P650</b> Page 77
Cable Control, Release Mechanism and Cable Assembly for Internal Valves	For 1-1/4, 2, 3 and 4 in. / DN 32, 50, 80 and 100 Internal Valves		<b>Types P314</b> Page 77
Relief Valve Pipeaway Adaptors for DOT	For Use with Types H284, H5114, H125, H150, H148 and H173 Valves		<b>Types P104-24, P174</b> Page 76
Filler Hose Adaptor with Back Check Valve	1-3/4 in. Female Acme by 1-3/4 in. Male Acme		<b>Type M570</b> Page 76

### Bulk Storage Tank and Valve Accessories

Product/Function	Selection Information		Type Number
Pneumatic Actuator	For Use with C407-10 Series Only		<b>Types P389 and P731</b> Page 61
Pneumatic Actuator	For Type C484-24 Jet Bleed Internal™ Valve		<b>Types P613 and P713</b> Page 61
Pneumatic Actuator	For Type C483-24 Jet Bleed Internal™ Valve		<b>Types P623 and P723</b> Page 61
Pneumatic Actuator	For Types C471 and C477 Jet Bleed Internal™ Valves (2 and 3 in. NPT Sizes)		<b>Types P639 and P739</b> Page 61
Pneumatic Actuator	For Type C404-32 4 in. / DN 100 Single Flanged Valve		<b>Types P614A and P714</b> Page 61
Pneumatic Actuator	For Closing and Opening of N551 Series Snappy Joe™ Emergency Shutoff Valves (ESVs)		<b>Type P539A</b> Page 62

**Bulk Storage Tank and Valve Accessories**

Product/Function	Selection Information		Type Number
Fuse Plug	208 to 220°F / 98 to 104°C Melting Temperature, Available in 1/8 and 1/4 in. MNPT Sizes		<b>T1140399982 / T1033699982</b> Page 61
Protective Caps for Relief Valves	For Types H110 through H174 Valves		<b>Type P206</b> Page 70
Seals and Plugs for Female Acme Threads	1-1/4 to 4-1/4 in. Male Acme		<b>Types M178, M535-34</b> Page 78
Female Acme Caps	Hand or Wrench Installation		<b>Type M108</b> Page 79
Clamp Hose Couplings	Swivel or Standard: 1/2 in. MNPT through 4-1/4 in. Female Acme for 1/2 through 3 in. Hose		<b>Type M3162</b> Page 80
Spanner Wrench for Large Female Acme Caps and Couplings	For Use with 2-1/4 through 4-1/4 in. Acme Threads		<b>Types P120B</b> Page 81
Ring and Chain Assemblies	For 1-1/4 through 4-1/4 in. Acme Caps or Dust Seals		<b>Type P147, P167 and P183</b> Page 80

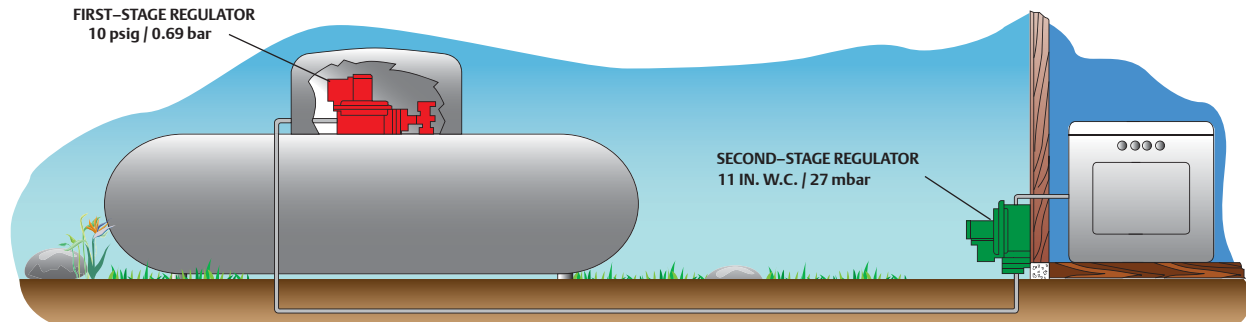

**Figure 1.** Two-Stage Regulation, One at Tank and One at Building, Reduce Pressure Down to Burner Pressure (11 in. w.c. / 27 mbar)

### Two-Stage Systems

Fisher™ regulators makes the LPG industry's largest variety of First and Second-Stage regulators for domestic and commercial/ industrial applications.

A Two-Stage system (Figure 1) uses two regulators to cut the supply pressure from the storage tank to the appliance. The Two-Stage system supplies a constant outlet pressure to the appliance. With more uniform pressure, appliances work better. Single-Stage regulators should be replaced with Two-Stage or Integral Two-Stage systems to comply with code requirements such as NFPA 58.

With a Two-Stage system, a First-Stage regulator supplies a nearly constant inlet pressure around 8 to 10 psig / 0.55 to 0.69 bar to a Second-Stage regulator. This means the Second-Stage unit does not have to attempt to compensate for widely varying inlet pressures. Second-Stage pressure can be adjusted at the building as desired.

### First-Stage Regulators

First-Stage regulators reduce tank pressure to a lower pressure (usually 10 psig / 0.69 bar) for a Second-Stage regulator. Fisher First-Stage regulators are painted red for easy identification. Vents are screened with standard orientation over the outlet.

### Two-psi Service Regulators

Two-psi Service regulators serve as an intermediate regulator after the First-Stage regulator. These regulators are designed for 2 psig / 0.14 bar LPG regulator systems. Fisher 2-psi regulators are painted white or are green with white closing caps for easy identification.

### Second-Stage Regulators

Second-Stage regulators reduce the pressure from a First-Stage unit to 11 in. w.c. / 27 mbar in domestic installations. Vents are screened with standard orientation over the inlet; however, other vent orientations are available. Fisher Second-Stage regulators are normally painted palm green for easy identification.

### Integral Two-Stage Regulators

Integral Two-Stage units combine a First-Stage regulator and Second-Stage regulator into one compact unit and are recommended for installations where piping distance between the building being served and the tank is short. Integral Two-Stage regulators provide all the advantages of Two-Stage regulation. These units are color coded gray for easy identification. Vents are screened with standard orientation over the outlet.

### Five Reasons to Two-Stage

#### 1. Compliance with Code Requirements such as NFPA 58

#### 2. Fewer Trouble Calls

With a Two-Stage system, one can expect fewer customer trouble calls due to regulator freeze-ups from too much water in the gas. A Two-Stage regulator reduces these possibilities in two ways:

- a larger orifice can be used, making it more difficult for ice to build up and block the orifice, and
- more heat can be transferred through the walls of two regulators than one

#### 3. Smaller Pipe or Tubing

Due to the higher pressure between the First and Second-Stage units, smaller pipe or tubing can be used on a Two-Stage system. These savings can make a Two-Stage system more economical to install than a Single-Stage.

#### 4. Constant Appliance Pressure

With a Two-Stage system, a First-Stage regulator supplies a nearly constant inlet pressure of 8 to 10 psig / 0.55 bar to 0.69 bar to a Second-Stage regulator. This means that the Second-Stage regulator does not have to attempt to compensate for widely varying inlet pressures. With more uniform pressure, appliances work better and customers are less likely to experience problems that result in service calls.

#### 5. Keep Downstream Pressure Below 2 psig / 0.14 bar

Second-Stage and Integral Two-Stage regulators have internal pressure relief valves, which limit the outlet pressure to 2 psig / 0.14 bar when the seat disc is removed and the inlet pressure is 10 psig / 0.69 bar or less as specified in UL® 144, STANDARD FOR LPG REGULATORS.

### When to Two-Stage

Two-Stage systems whenever the following conditions exist:

1. Compliance with regulation codes.
2. There is a possibility of moisture in the LPG.
3. Wide fluctuations in gas demand exist.
4. Winter and summer temperatures vary greatly.

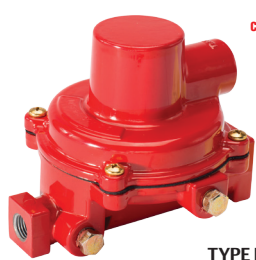

TYPE R122H

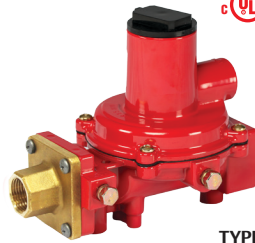

TYPE R222H

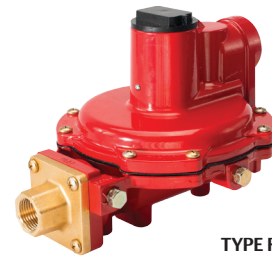

TYPE R622H



**Types R122H, R222H and R622H** First-Stage Regulators are Underwriters Laboratories (UL®) listed regulators designed for Two-Stage LPG systems. These First-Stage regulators reduce tank pressure to a lower pressure (usually 10 psig / 0.69 bar) for a Second-Stage regulator. Maximum allowable inlet pressure is 250 psig / 17.2 bar. Fisher™ First-Stage regulators are painted red for easy identification. Vents are screened with standard orientation over the outlet. The Types R122H, R222H and R622H regulators have a temperature rating of -20 to 160°F / -29 to 71°C, but have passed Fisher internal testing for lockup, relief start-to-discharge and reseal down to -40°F / -40°C. The design's superior relief performance exceeds UL requirements and provides double failure overpressure protection (pressure downstream of the second regulator will be limited close to 2 psig / 0.14 bar, even if both regulators are damaged) when used with R600 Series Second-Stage regulator. Corrosion and wear resistant materials and stainless steel internal parts provide a recommended replacement life of 20 years. A large fabric reinforced diaphragm with molded lips provide precise regulation. The large precision machined orifice assists in minimizing freeze testing problems. 1/8 in. inlet and outlet gauge taps allow easy system testing. Large inlet and outlet wrench

flats for easy installation. The unit's Fluorocarbon (FKM) valve disc provides better lockup performance and durability in contaminated gas. The vent is with 3/8 in. NPT for easy installation of vent piping.

**Type R122H** – Designed for use in domestic applications, the Type R122H's size makes it perfect for tight installations. Its non-adjustable setpoint makes the unit virtually tamper proof. The outlet pressure setpoint remains at a nominal factory setting of 10 psig / 0.69 bar.

**Type R222H** – First stage regulator with all Type R622H benefits stated above, but with a compact profile. 65% greater flow than typical compact regulators but with a 40% smaller footprint. It is perfect for underground tanks or limited dome spaces.

**Type R622H** – High Flow First-Stage regulator with multiple end connections and adjustable outlet pressure spring ranges. A large 3/4 in. FNPT drip-lip vent reduces the chance of blockage by freezing rain or sleet when properly installed with the vent pointing down. Each Type R622H is equipped with a corrosion-resistant internal relief valve that provides high capacity relief and a travel stop on the closing cap. Its size and configuration make it ideal for under-the-dome installations.

### First-Stage Regulators

TYPE	CAPACITIES (PROPANE) <sup>(1)(3)</sup>		INLET CONNECTION, IN.	OUTLET CONNECTION, IN.	OUTLET ADJUSTMENT RANGE		OUTLET PRESSURE SETTING		NOMINAL RELIEF VALVE START-TO-DISCHARGE	
	BTU / hr	SCMH			psig	bar	psig	bar	psig	bar
R122H-AAJ R122H-AAJXB <sup>(2)</sup>	1,100,000	12.4	1/4 FNPT	1/2 FNPT	Non-Adjustable		10	0.69	----	----
R222H-BGK	1,700,000	19.1	1/2 FNPT	1/2 FNPT	4 to 6	0.28 to 0.41	5	0.34	9	0.62
R222H-BGJ	1,800,000	20.2			8 to 12	0.55 to 0.82	10	0.69	16	1.10
R222H-HGK	1,700,000	19.1	FPOL	1/2 FNPT	4 to 6	0.28 to 0.41	5	0.34	9	0.62
R222H-HGJ	1,800,000	20.2			8 to 12	0.55 to 0.82	10	0.69	16	1.10
R222H-JGK	1,875,000	21.1	FPOL	3/4 FNPT	4 to 6	0.28 to 0.41	5	0.34	9	0.62
R222H-JGJ	1,875,000	21.1			8 to 12	0.55 to 0.82	10	0.69	16	1.10
R222H-DGK	2,000,000	22.5	3/4 FNPT	3/4 FNPT	4 to 6	0.28 to 0.41	5	0.34	9	0.62
R222H-DGJ	2,000,000	22.5			8 to 12	0.55 to 0.82	10	0.69	16	1.10
R622H-BGK R622H-HGK	2,000,000	22.5	1/2 FNPT FPOL	1/2 FNPT	4 to 6	0.28 to 0.41	5	0.34	----	----
R622H-JGK	2,250,000	25.3	FPOL	3/4 FNPT						
R622H-BGJ	2,100,000	23.6	1/2 FNPT	1/2 FNPT	8 to 12	0.55 to 0.83	10	0.69	----	----
R622H-DGJ	2,400,000	27.0	3/4 FNPT	3/4 FNPT						
R622H-HGJ	2,100,000	23.6	FPOL	1/2 FNPT						
R622H-JGJ	2,250,000	25.3		3/4 FNPT						

1. Based on 30 psig / 2.1 bar inlet pressure and 20% droop.  
 2. Vent over gauge taps.  
 3. Metric conversion is based on 2516 BTU/ft<sup>3</sup> of gas at 60°F / 16°C.

# Second-Stage Regulators

## Regulators

FISHER™



**Types R222, R622, R642, R652 and HSRL** Second-Stage regulators are Underwriters Laboratories (UL®) listed regulators designed to reduce the outlet pressure from a First-Stage regulator, usually 10 psig / 0.69 bar to 11 in. w.c. / 27 mbar, in domestic installations. Vents are screened with standard orientation over the inlet, but other orientations are available. Fisher™ Second-Stage regulators are painted palm green for easy identification. Types R222, R622, R642 and R652 are equipped with a stainless steel inlet screen to reduce the amount of debris entering the regulator and have a temperature rating of -20 to 160°F / -29 to 71°C, but have passed Fisher internal testing for lockup, relief start-to-discharge and reseal down to -40°F / -40°C.

**Type R222** is designed for small domestic applications up to 650,000 BTU per hour / 7.3 SCMH. The unit provides the same features as the Type R622 in a smaller package and its design provides a recommended replacement life of 20 years.

**Type R622** is designed for Two-Stage domestic applications up to 1,400,000 BTU per hour / 15.8 SCMH. The Type R622's time proven design and corrosion resistant materials, provide a recommended replacement life of 20 years.

Type R622 contains a high performance relief valve and a large 3/4 in. screened vent to limit downstream pressure to less than 2 psig / 0.14 bar

in an overpressure situation as required by NFPA 58. The relief valve design exceeds the industry standard by limiting the downstream pressure to 2 psig / 0.14 bar even in a double failure situation when used with a Type R622H or R122H First-Stage regulator. The Type R622 is adjustable from 9 to 20 in. w.c. / 22 to 50 mbar.

For easy system checks, the Type R622 has 1/8 in. NPT built-in gauge taps orificed to a No. 54 drill size, on both the upstream and downstream sides. This regulator also features a large 3/4 in. drip-lip vent design.

**Types R642 and R652** are designed for domestic applications up to 920,000 / 10.4 and 1,000,000 BTU per hour / 11.3 SCMH, respectively. These units provide all the same features as the Type R622, including the 20-year recommended replacement life and double failure protection, in an angle body for the Type R642 and backmounted design for the Type R652.

**Type HSRL** is an UL listed regulator designed for light commercial applications up to 2,600,000 BTU per hour / 29.3 SCMH. It utilizes a high strength cast iron body and a 3/4 in. NPT drip lip vent design. The PFC and SFC feature an angle-body design. The design also includes a high capacity internal relief valve and a 20-year recommended replacement life.

### Second-Stage Regulators

TYPE	CAPACITIES (PROPANE) <sup>(1)</sup>		INLET CONNECTION, IN.	OUTLET CONNECTION, IN.	OUTLET PRESSURE RANGE		OUTLET PRESSURE SETTING	
	BTU / hr	SCMH			In. w.c.	mbar	In. w.c.	mbar
R222-BAF <sup>(2)</sup>	650,000	7.3	1/2 FNPT	1/2 FNPT	9.5 to 13	24 to 32		
R622-BCF <sup>(2)</sup>	875,000	9.8	1/2 FNPT	1/2 FNPT				
R622-CFF <sup>(2)(4)</sup>	1,400,000	15.8	1/2 FNPT	3/4 FNPT	9 to 13	22 to 32	11	27
R622-DFF <sup>(5)</sup>			3/4 FNPT					
R642-DFF <sup>(2)</sup>	920,000	10.4	3/4 FNPT					
R652-CFF	1,000,000	11.3	1/2 FNPT					
R652-DFF			3/4 FNPT					
R622-CFGXA <sup>(3)</sup>	1,125,000	12.7	1/2 FNPT	3/4 FNPT	13 to 20	32 to 50	18	45
HSRL-BFC	2,300,000	25.9	3/4 FNPT	3/4 FNPT	9 to 13	22 to 32	11	27
HSRL-PFC								
HSRL-CFC								
HSRL-SFC	2,600,000	29.3	1 FNPT	1 FNPT				

1. Based on 10 psig / 0.69 bar inlet pressure and 2 in. w.c. / 5 mbar droop.  
 2. Consult factory for alternate vent over outlet position as "XA" option  
 3. Vent over Inlet as standard  
 4. Consult factory for alternate vent opposite gauge taps as "XB" option  
 5. Consult factory for alternate vent over outlet position as "XB" option



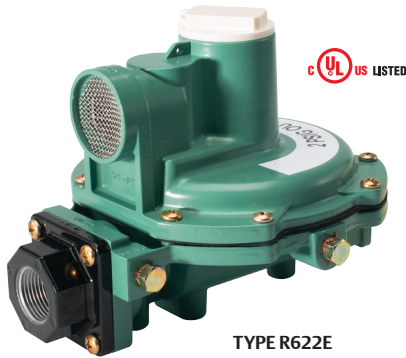

**Types R622E and R652E**, Two-psi Service Regulators, are designed for Two-psi LPG Regulator Systems and listed by Underwriters Laboratories (UL®). These units are installed downstream from a First-Stage regulator and reduce an inlet pressure of 10 psig / 0.69 bar to a nominal 2 psig / 0.14 bar outlet pressure. Two-psi Service Regulators are designed for domestic applications that supply 2 psig / 0.14 bar LPG to a line regulator located inside the building. In most cases a manifold is used with corrugated stainless steel tubing (CSST) as well as other acceptable piping materials for routing to the line pressure regulator supplying approximately 11 in. w.c. / 27 mbar to appliance regulators.

**Types R622E and R652E**, Two-psi Service Regulators feature a combination relief valve and large vent that provide overpressure protection and exceed UL requirements. Both units have a stainless steel inlet screen to reduce the amount of debris from entering them. Fisher™ Types R622E and R652E are painted green with a white closing cap for

easy identification and have a temperature rating of -20 to 160°F / -29 to 71°C, but have passed Fisher internal testing for lockup, relief start-to-discharge and reseal down to -40°F / -40°C.

**Type R622E** – Time proven design constructed of corrosion resistant materials, the Type R622E is designed to provide a recommended replacement life of 20 years. Fisher regulator’s fabric-reinforced diaphragm and large diaphragm area provide accurate regulation at increased capacities. All components provide superior resistance to field conditions that may cause wear and corrosion. Built-in 1/8 in. taps (orificed to a number 54-drill size) on the upstream and downstream sides allow for easy gas system checks.

**Type R652E** – Provides the same features as the Type R622E, includes a 20-year recommended replacement life with a back mount design.

## Typical Two-psi Installation

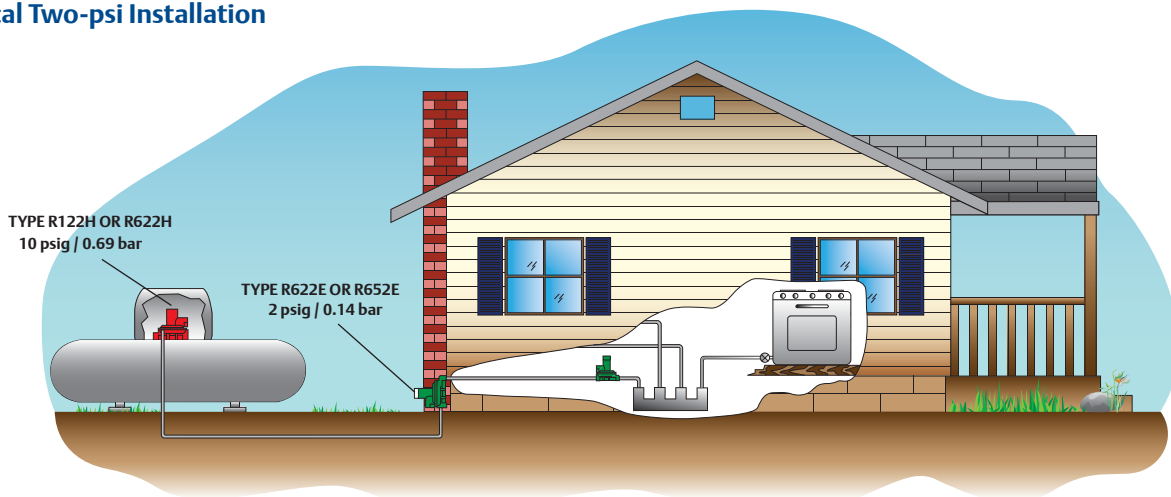

### Two-psi Service Regulators

TYPE	CAPACITIES (PROPANE) <sup>(1)</sup>		CONNECTION INLET X OUTLET, IN.	OUTLET PRESSURE RANGE		OUTLET PRESSURE SETTING	
	BTU / hr	SCMH		psig	bar	psig	bar
R622E-BCH	1,460,000	16.4	1/2 x 1/2 FNPT	1 to 2.2	69 mbar to 0.15	2	0.14
R622E-DCH	1,680,000	18.9	3/4 x 3/4 FNPT				
R652E-DFH	1,500,000	16.9					

1. Based on 10 psig / 0.69 bar inlet pressure and 20% droop.

# Integral Two-Stage Regulators

## Regulators

FISHER™

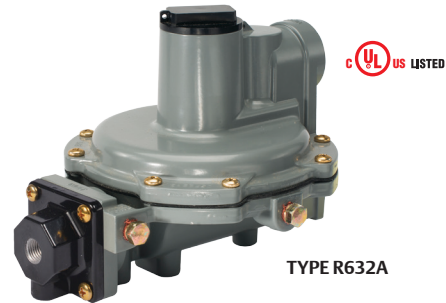
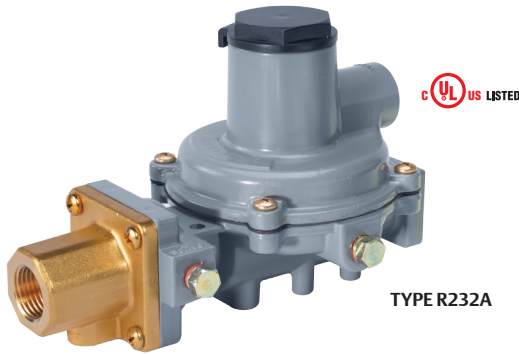

Integral Two-Stage regulators combine a First-Stage regulator and a Second-Stage regulator into one compact unit. Recommended for installations where piping distance is short, integral Two-Stage regulators provide all of the advantages of Two-Stage regulation (refer to page 24). Fisher™ integral Two-Stage regulators are color coded gray for easy identification. Vents are screened with standard Second-Stage vent orientation over the outlet. The Types R632A and R232A first-stage screened vent is threaded to accept a 1/4 in. OD copper tube inverted flare with a 7/16-24 UN thread. The Types R232A and R632A have a temperature rating of -20 to 160°F / -29 to 71°C, but have passed Fisher internal testing for lockup, relief start-to-discharge and reseal down to -40°F / -40°C.

**Type R632A** – is an Underwriters Laboratories (UL®) listed regulator with a capacity of up to 950,000 BTU per hour / 10.7 SCMH, recommended for on-site cylinder installations, mobile homes and domestic installations, where separation of the First and Second-Stage is not cost effective. This unit offers a POL inlet connection for the easy drop-in replacement of Single-Stage regulators.

Type R632A's high capacity relief valve and large 3/4 in. screened vent limit downstream pressure to less than 2 psig / 0.14 bar in an overpressure situation as required by NFPA 58. Type R632A is adjustable from 9 to 13 in. w.c. / 22 to 32 mbar, with a factory setpoint of 11 in. w.c. / 27 mbar. The Type R632A features include the 20-year recommended replacement life.

Type R632A has 1/8 in. NPT built-in gauge taps orificed to a No. 54 drill size, on the upstream and downstream sides. These taps provide easy access for testing the proper operation of the First and Second-Stage while the system is pressurized. This regulator also features a large 3/4 in. drip-lip vent to reduce the chance of blockage by freezing rain or sleet when properly installed with the vent pointing down.

**Type R232A** – Designed for installations with small capacity loads up to 550,000 BTU per hour / 6.2 SCMH. With an overall length of 6.5 or 7 in. / 165 or 178 mm for NPT or FPOL connections respectively, this compact unit fits easily into confined spaces and is ideal for ASME tanks used on small domestic loads. Intermediate and outlet gauge taps facilitate easy system testing. A 3/8 in. NPT vent allows easy installation of vent piping. Use of a valve stem and lever provide stable regulation and excellent durability. A large fabric-reinforced diaphragm provides accurate regulation. The large orifice assists in minimizing freeze problems. Stainless steel internal and corrosion resistant coatings provide excellent corrosion resistance. The Type R232A also has the design that provides a recommended replacement life of 20 years.

**Twin Cylinder Installations** – The Type R232A can also be used on twin cylinder hook-ups found on travel trailers and stationary applications. These units offer a drip-lip vent style for installations without a vent protector. Proper installation requires the vent to be pointed down in a vertical position. Additional protection may be required if road splatter is a problem.

Integral Two-Stage Regulators								
TYPE NUMBER	CAPACITIES (PROPANE) <sup>(1)</sup>		INLET CONNECTION, IN.	OUTLET CONNECTION, IN.	OUTLET ADJUSTMENT RANGE		OUTLET PRESSURE SETTING	
	BTU / hr	SCMH			In. w.c.	mbar	In. w.c.	mbar
R232A-BBF	550,000	6.2	1/4 FNPT	1/2 FNPT	10.2 to 13	25 to 32		
R232A-BBFXA <sup>(2)</sup>								
R232A-HBF								
R232A-HBFXA <sup>(2)</sup>								
R632A-BCF	850,000	9.6	1/4 FNPT	1/2 FNPT	9 to 13	22 to 32	11	27
R632A-BCFXA <sup>(2)</sup>								
R632A-CFF								
R632A-CFFXA <sup>(2)</sup>	950,000	10.7		3/4 FNPT				
R632A-HCF	850,000	9.6	FPOL	1/2 FNPT				
R632A-HCFXA <sup>(2)</sup>								
R632A-JFF	850,000	9.6	FPOL	3/4 FNPT				
R632A-JFFXA <sup>(2)</sup>								

1. Based on 30 psig / 2.1 bar inlet pressure and 2 in. w.c. / 5 mbar droop.  
2. First and Second-Stage spring case vents opposite gauge taps.

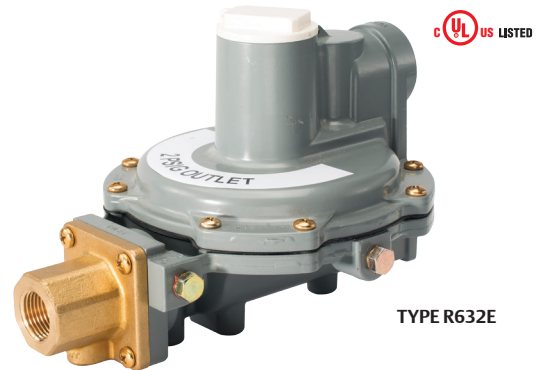
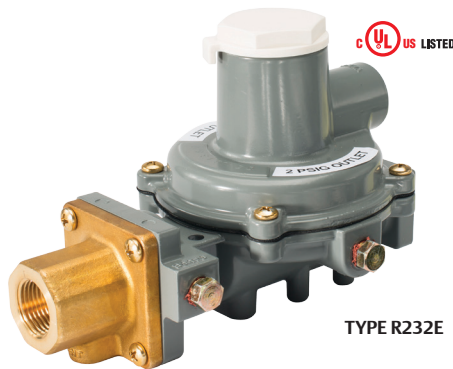

Integral Two-psi regulators combine a First-Stage regulator and a Second-Stage, Two-psi regulator into one compact unit. Recommended for installations where piping distance is short, integral Two-Stage, Two-psi regulators provide all of the advantages of Two-Stage regulation (refer to page 23). Fisher™ integral Two-Stage, Two-psi regulators are color coded gray with a white cap and white UV rated cover for easy identification. Vents are screened with standard Second-Stage vent orientation over the outlet. The Types R632E and R232E first-stage screened vent is threaded to accept a 1/4 in. OD copper tube inverted flare with a 7/16-24 UN thread. The Types R23E and R632E have a temperature rating of -20 to 160°F / -29 to 71°C, but have passed Fisher internal testing for lockup, relief start-to-discharge and reseal down to -40°F / -40°C.

**Type R632E** – is an Underwriters Laboratories (UL®) listed regulator with a capacity of up to 810,000 BTU per hour / 9.1 SCMH, recommended for on-site cylinder installations, mobile homes and domestic installations, where separation of the First and Second-Stage is not cost effective. This unit offers a POL inlet connection for the easy drop-in replacement of Single-Stage regulators.

Type R632E's high capacity relief valve and large 3/4 in. screened vent limit downstream pressure to less than 5 psig / 0.34 bar in an overpressure situation as required by NFPA 58. Type R632E is adjustable from 1 to 2.2 psig / 69 to 152 mbar, with a factory setpoint of 11 in. w.c. / 27 mbar. The Type R632E features a 20-year recommended replacement life.

Type R632E has 1/8 in. NPT built-in gauge taps orificed to a No. 54 drill size, on the upstream and downstream sides. These taps provide easy access for testing the proper operation pressure of the First and Second-Stage while the system is pressurized. This regulator also features a large 3/4 in. drip-lip vent to reduce the chance of blockage by freezing rain or sleet when properly installed with the vent pointing down.

**Type R232E** – Designed for installations with small capacity loads up to 450,000 BTU per hour / 5.1 SCMH. With an overall length of 6.5 or 7 in. / 165 or 178 mm for NPT or FPOL connections respectively, this compact unit fits easily into confined spaces and is ideal for ASME tanks used on small domestic loads. Intermediate and outlet gauge taps facilitate easy system testing. A 3/8 in. NPT vent allows easy installation of vent piping. Use of a valve stem and lever provide stable regulation and excellent durability. A large fabric-reinforced diaphragm provides accurate regulation. The large orifice assists in minimizing freeze problems. Stainless steel internal and corrosion resistant coatings provide excellent corrosion resistance. The Type R232E also has the design that provides a recommended replacement life of 20 years.

**Twin Cylinder Installations** – The Type R232E can also be used on twin cylinder hook-ups found on travel trailers and stationary applications. These units offer a drip-lip vent style for installations without a vent protector. Proper installation requires the vent to be pointed down in a vertical position. Additional protection may be required if road splatter is a problem.

Integral Two-psi Regulators								
TYPE	CAPACITIES (PROPANE) <sup>(1)</sup>		INLET CONNECTION, IN.	OUTLET CONNECTION, IN.	OUTLET ADJUSTMENT RANGE		OUTLET PRESSURE SETTING	
	BTU / hr	SCMH			psig	mbar	psig	mbar
R232E-BBH	500,000	5.6	1/4 FNPT	1/2 FNPT	1 to 2.2	69 to 152	2	138
R232E-BBHXA <sup>(2)</sup>			FPOL					
R232E-HBH				1/4 FNPT				
R232E-HBHXA <sup>(2)</sup>			3/4 FNPT					
R632E-BCH	850,000	9.6		1/4 FNPT	1/2 FNPT	1 to 2.2	69 to 152	2
R632E-BCHXA <sup>(2)</sup>								
R632E-CFH	850,000	9.6	FPOL	1/2 FNPT				
R632E-CFHXA <sup>(2)</sup>					3/4 FNPT			
R632E-HCH	900,000	10.1	FPOL	1/2 FNPT				
R632E-HCHXA <sup>(2)</sup>					3/4 FNPT			
R632E-JFH	850,000	9.6	FPOL	3/4 FNPT				
R632E-JFHXA <sup>(2)</sup>								

1. Based on 30 psig / 2.1 bar inlet pressure and 20% droop.  
 2. First and Second-Stage spring case vents opposite gauge taps.

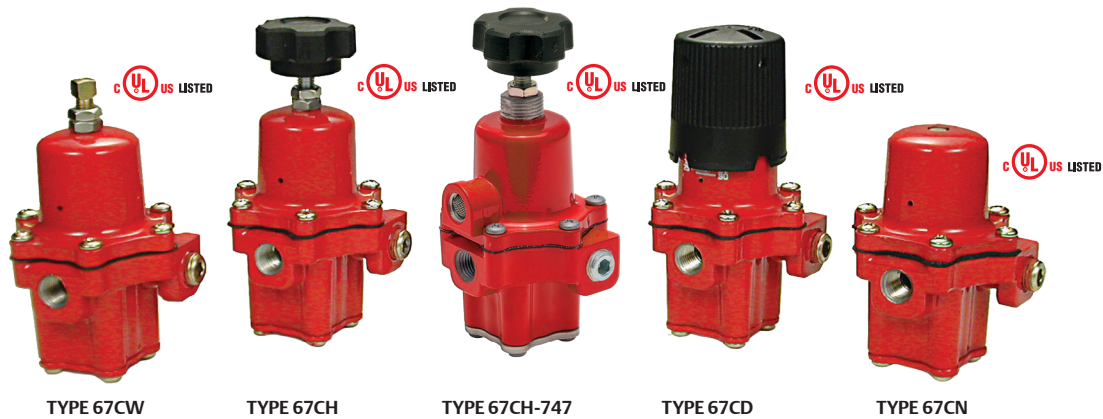

### 67C Series

Suitable for liquid or vapor service, the 67C Series high-pressure (pounds-to-pounds) regulators are used on a variety of applications. All types within the series have a 1/4 in. FNPT side outlet in which a pressure gauge (J500 Series) can be installed. The compact size of the 67C Series regulators make them particularly useful on installations where space is limited. The regulator design utilizes precise guiding of the valve plug to provide close regulation and high performance. The LPG 67C Series has a temperature rating of -20 to 180°F / -29 to 82°C.

**Type 67CW** – Standard regulator with wrench adjustment.

**Type 67CH** – Standard regulator with handwheel adjustment. Also available with 1/4 in. NPT threaded exhaust port, Type 67CH-747<sup>(2)</sup>.

**Type 67CD** – With dial calibration accuracy nearly equivalent to that of a commercial pressure gauge, the Type 67CD eliminates the need for a pressure gauge on portable applications.

Outlet pressure is calibrated on the spring case allowing visual adjustment of the outlet pressure without having to use a pressure gauge. The unit is ideal for service where gauge breakage is a problem.

**Type 67CN** – Extremely compact unit with a fixed (non-adjustable) outlet setting and a tamper resistant spring case. Three different setpoints are available: 10, 15 and 20 psig / 0.69, 1.0 and 1.4 bar.

**Note: 67C Series regulators do not have an internal relief and should be installed with additional/external overpressure protection. These units should not be installed in fixed piping serving 14 in. w.c. / 35 mbar appliance systems. Please consult with your LPG Equipment Distributor for more information.**

High-Pressure Regulators								
TYPE	DESCRIPTION	CAPACITIES (PROPANE) <sup>(1)</sup>		OUTLET PRESSURE SETTING		OUTLET ADJUSTMENT RANGE		INLET AND OUTLET CONNECTIONS, IN.
		BTU / hr	SCMH	psig	bar	psig	bar	
67CW-683	Basic Regulator (Wrench Adjustment)	675,000	7.6	15	1.0	3 to 20	0.21 to 1.4	1/4 FNPT
67CW-684		750,000	8.4	20	1.4	3 to 35	0.21 to 2.4	
67CW-685		1,200,000	13.5	40	2.8	30 to 60	2.1 to 4.1	
67CW-701		1,000,000	11.3	50	3.4	50 to 120	3.4 to 8.3	
67CH-751	Basic Regulator (Handwheel Adjustment)	675,000	7.6	15	1.0	3 to 20	0.21 to 1.4	
67CH-743		750,000	8.4	20	1.4	3 to 35	0.21 to 2.4	
67CH-742		1,200,000	13.5	40	2.8	30 to 60	2.1 to 4.1	
67CH-741		1,000,000	11.3	50	3.4	50 to 120	3.4 to 8.3	
67CH-745	Basic Regulator (Handwheel Adjustment) with Type M318 installed	750,000	8.4	20	1.4	3 to 35	0.21 to 2.4	
67CH-747 <sup>(2)</sup>	Basic Regulator (Handwheel Adjustment with 1/4 in. NPT Exhaust Vent)	750,000	8.4	20	1.4	3 to 35	0.21 to 2.4	
67CD-100	Dial Cap Adjustment	675,000	7.6	15	1.0	5 to 20	0.34 to 1.4	
67CD-102		1,200,000	13.5	40	2.8	20 to 50	1.4 to 3.4	
67CD-103		1,000,000	11.3	50	3.4	40 to 100	2.8 to 6.9	
67CN-106	Non-Adjustable	400,000	4.5	10	0.69	Non-Adjustable		
67CN-104		600,000	6.7	15	1.0	Non-Adjustable		
67CN-105		750,000	8.4	20	1.4	Non-Adjustable		

1. Based on inlet pressure 20 psig / 1.4 bar greater than outlet with 20% droop; Liquid capacity = 3 to 5 GPH / 11.4 to 18.9 l/hr.  
2. Per CSA B149.1, section 5.5.1



64 SERIES

### 64 Series

High-pressure (pounds-to-pounds) regulators usually reduce tank pressure to an intermediate pressure for use by another regulator. They may be used as high-pressure regulators on distribution systems when used in conjunction with a First-Stage downstream regulator. The Type 64SR may be used for First-Stage when set at 10 psig / 0.69 bar. They are also used for Final-Stage service on high-pressure burners in crop dryers and tobacco curers, as well as other medium sized commercial/industrial applications.

The 1/4 in. FNPT side outlet, which is normally plugged, provides an opening for an outlet pressure gauge. Standard 64's Series are capable of handling liquid or vapor at temperatures under 150°F / 66°C. A cover or auxiliary vent assembly should be used to protect the 1/4 in. FNPT regulator vent opening on outdoor installations. Temperature rating for the 64 and 64SR Series has a temperature rating from -20 to 150°F / -29 to 66°C.

**64 Series** – is an adjustable high-pressure regulator with a wide range of available outlet pressure ranges. It does not contain a relief valve.

It should always be used in conjunction with a downstream regulator and/or separate relief devices in compliance with NFPA 58 overpressure protection requirements.

**Type 64SR** – is a high-pressure regulator, which has an internal relief valve. As such it may be used as a Final-Stage regulator on high-pressure systems. It may also be used as a First-Stage regulator when set at 10 psig / 0.69 bar or less.

**Note: 64 Series regulators do not have an internal relief and should be installed with additional/external overpressure protection. These units should not be installed in fixed piping serving 14 in. w.c. / 35 mbar appliance systems. Please consult with your LPG Equipment Distributor for more information.**

**Note: If the installation location makes the ignition of vented gas a possibility, then a vent line should be installed from the Type 64SR vent to a safe location.**

High-Pressure Regulators								
TYPE	DESCRIPTION	CAPACITIES (PROPANE) <sup>(1)</sup>		OUTLET PRESSURE SETTING		OUTLET ADJUSTMENT RANGE		INLET AND OUTLET CONNECTIONS, in.
		BTU / hr	SCMH	psig	bar	psig	bar	
64-33	Basic Regulator	2,625,000	29.6	10	0.69	3 to 15	0.21 to 1.0	1/2 FNPT
64-35		3,600,000	40.5	20	1.4	5 to 35	0.34 to 2.4	
64-36		4,150,000	46.7	40	2.8	30 to 60	2.1 to 4.1	
64-222		5,250,000	59.1	50	3.4	35 to 100	2.4 to 6.9	
64SR-21	With Internal Relief Valve	2,625,000	29.6	10	0.69	3 to 15	0.21 to 1.0	
64SR-22		3,000,000	33.8	15	1.0	5 to 20	0.34 to 1.4	
64SR-23		3,600,000	40.5	20	1.4	5 to 35	0.34 to 2.4	

1. Based on inlet pressure 20 psig / 1.4 bar greater than outlet with 20% droop; Liquid capacity = 160 GPH / 606 l/hr.



TYPE 627 DIRECT-OPERATED REGULATOR



TYPE 630 DIRECT-OPERATED REGULATOR

For Commercial and Industrial high-pressure applications like factories, office building, restaurants, etc., Emerson has a wide variety of products. For ease of reference, only the most popular commercial and industrial regulators are shown in these pages. Other orifice sizes, body sizes and outlet pressure ranges are available. The higher capacities on commercial and industrial installations usually require a Two-Stage regulator system.

**Note: Because of various spring ranges and orifice sizes, all commercial and industrial regulators should be individually sized for the particular installation. Consult specific product bulletins for maximum pressure ratings. Contact your local LPG Equipment Distributor for assistance.**

**Types 627 and 630** – Large capacity direct-operated high-pressure regulators designed for loads up to 10,700,000 and 14,000,000 BTU per hour / 120 and 157 SCMH, respectively. The Types 627 and 630 are normally used in conjunction with Type CS400 units, however, they can also be used on Final-Stage (pounds-to-pounds) service. Additional overpressure protection is recommended to prevent excessive build-up in the downstream line. The diaphragm case and body of the Type 627 can be rotated in four positions to allow easy installation. Additional configurations of the Type 627 with internal relief and control line connections for monitor systems are available. For both the Types 627 and 630, additional pressure ranges and orifice sizes are available. Temperature ratings for the Types 627 and 630 is -20 to 160°F / -29 to 71°C.

**For Liquid Service**, Types 627W and MR95H are available.

**Note: Types 627 and 630 regulators do not have an internal relief and should be installed with additional/external overpressure protection. These units should not be installed as part of a two-stage system in fixed piping serving 14 in. w.c. / 35 mbar appliance systems unless additional overpressure protection is installed that will make the system compliant with NFPA 58 requirements for a two-stage system. Please consult with your LPG Equipment Distributor for more information.**

**Flanged Bodies** – The Types 630 and 627 are available with flanged bodies. Flanges are available for 2 in. CL300 FF.

**Overpressure Protection** – The Type 627 is also available in monitor configurations. Note that the Type 627 monitor regulators have unique type numbers. For more information on monitor overpressure protection, see page 42.

**Fluorocarbon (FKM) Trim** – The Type 627 is available with Fluorocarbon (FKM) Trim for high temperature applications such as vaporizers. Part numbers are listed below with a 'V' suffix. Temperature ratings for the Type 627 with Fluorocarbon (FKM) Trim is 0 to 180°F / -18 to 82°C.

**Type 1301F** – The proven reliability and accurate regulation of the Type 1301F regulator makes it ideal for numerous high-pressure drop applications. This multi-purpose regulator can be used as pilot supply or pressure-loading regulators where high-pressure operating medium must be reduced for use by gas regulator pilots or pressure-loaded regulators.

UL® Listed Type 627 Constructions											
TYPE	CAPACITIES <sup>(1)</sup> PROPANE		ORIFICE SIZE		INLET AND OUTLET CONNECTION	OUTLET PRESSURE RANGE		SETPOINT		MAXIMUM OPERATING INLET PRESSURE	
	BTU / hr	SCMH	In.	mm		psig	bar	psig	bar	psig	bar
627-5810	6,080,000	68.4	3/8	9.5	3/4 in. FNPT	5 to 20	0.34 to 1.4	10	0.69	250	17.2
627-5810V											
627-6210	10,755,000	121	1/2	13	1 in. FNPT	5 to 20	0.34 to 1.4	10	0.69	250	17.2
627-6210V											
627-7710	10,773,000	121	1/2	13	1 in. FNPT	5 to 20	0.34 to 1.4	10	0.69	250	17.2
627-7710V											

1. For UL listed Type 627 configurations, capacity based on inlet pressure of 30 psig / 2.1 bar Internal registration and 20% droop.  
NOTE: Additional spring ranges and body styles available. Ask your LPG Equipment Distributor for additional configurations and for more information.

Non-UL listed Type 627 Constructions											
TYPE	CAPACITIES <sup>(2)</sup> PROPANE		ORIFICE SIZE		INLET AND OUTLET CONNECTION	OUTLET PRESSURE RANGE		SETPOINT		MAXIMUM OPERATING INLET PRESSURE	
	BTU / hr	SCMH	In.	mm		psig	bar	psig	bar	psig	bar
627R-117 <sup>(3)</sup>	10,755,000	121	1/2	13	3/4 in. FNPT	5 to 20	0.34 to 1.4	10	0.69	200	13.8
627M-421 <sup>(4)</sup>										250	17.2
627R-197 <sup>(3)</sup>	10,773,000	121	1/2	13	1 in. FNPT	5 to 20	0.34 to 1.4	10	0.69	200	13.8
627M-471 <sup>(4)</sup>										250	17.2
627-497	14,837,000	167	1/2	13	2 in. FNPT	15 to 40	1.0 to 2.8	40	2.8	250	17.2
627-577	20,948,000	235	1/2	13	2 in. FNPT	15 to 40	1.0 to 2.8	40	2.8	250	17.2

2. For Non-UL listed Types 627 and 630 configurations, capacity based on inlet pressure 20 psig / 1.4 bar greater than outlet pressure, Internal registration and 20% droop.  
3. "R" denotes token relief. Check with your LPG Equipment Distributor on relief capacities.  
4. For monitor applications. Standard with blocked throat and external sensing.  
NOTE: Additional spring ranges and body styles available. Ask your LPG Equipment Distributor for additional configurations and for more information.

Type 630 Regulator											
TYPE	CAPACITIES IN BTU PER HOUR / SCMH PROPANE <sup>(2)</sup>		ORIFICE SIZE		INLET AND OUTLET CONNECTION	OUTLET PRESSURE RANGE		SETPOINT		MAXIMUM OPERATING INLET PRESSURE	
	BTU / hr	SCMH	In.	mm		psig	bar	psig	bar	psig	bar
630-104-78	14,000,000	158	1/2	13	2 in. FNPT	8 to 20	0.55 to 1.4	10	0.69	250	17.2

2. For Non-UL listed Types 627 and 630 configurations, capacity based on inlet pressure 20 psig / 1.4 bar greater than outlet pressure, Internal registration and 20% droop.  
NOTE: Additional spring ranges and body styles available. Ask your LPG Equipment Distributor for additional configurations and for more information.

# Commercial/Industrial High-Pressure Regulators

For Commercial and Industrial high-pressure applications, such as distributed community systems, factories, office buildings, restaurants, Emerson has a wide variety of products and solutions. For ease of reference, only the most popular commercial and industrial regulators are shown on these pages. Other orifice sizes, body sizes and outlet pressure ranges are available. The higher capacities on commercial and industrial installations usually require a Two-stage regulator system. Temperature ratings for the Type 99 is -20 to 180°F / -29 to 82°C.

**Note: Because of various spring ranges and orifice sizes, all commercial and industrial regulators should be individually sized for the particular installation. Consult specific product bulletins for maximum pressure ratings. Contact your local LPG Equipment Distributor for assistance.**

**Type 99** – Pilot-operated unit keeps outlet pressure constant despite varying flow rates and inlet pressures. Designed to handle loads up to 74,318,000 BTU per hour / 837 SCMH, the Type 99 is ideal for multiple customer installations. The unique pilot design, with fast opening and closing operation, makes the Type 99 ideal for large industrial boiler applications. The Type 99 can be used for low or high-pressure applications. A downstream control line is required. Additional overpressure protection is recommended to prevent excessive buildup in the downstream line.

**Note: Type 99 regulators do not have an internal relief and should be installed with additional/external overpressure protection. These units should not be installed as part of a two-stage system in fixed piping serving 14 in. w.c. / 35 mbar appliance systems unless additional overpressure protection is installed that will make the**



TYPE 99-901PH PILOT-OPERATED REGULATOR

**system compliant with NFPA 58 requirements for a two-stage system. Please consult with your LPG Equipment Distributor for more information.**

**Flanged Bodies** - 99F Series is equipped with 2 in. CL300 flanged bodies.

**Overpressure Protection** - The Type 99 is also available in monitor configurations. Note that the Type 99 monitor regulators have unique type numbers. For more information on monitor overpressure protection, see page 42.

## Pilot-Operated High-Pressure Commercial/Industrial Regulators

TYPE	CAPACITIES (PROPANE) <sup>(1)</sup>		ORIFICE SIZE		INLET AND OUTLET CONNECTION	OUTLET PRESSURE RANGE		OUTLET PRESSURE SETTING		MAXIMUM OPERATING INLET PRESSURE																																																																																																			
	BTU / hr	SCMH	In.	mm		psig	bar	psig	bar	psig	bar																																																																																																		
99-510P	29,400,000	331	7/8	22	2 in. FNPT	7 in. w.c. to 2	17 mbar to 0.14	1	69 mbar	250	17.2																																																																																																		
99F-510P					2 in. / DN 50 CL300 FF							99-511P	33,206,000	374	2 in. FNPT	1 to 5	69 mbar to 0.34	5	0.34	99F-511P	2 in. / DN 50 CL300 FF	99-513P	36,368,000	409	2 in. FNPT	2 to 10	0.14 to 0.69	10	0.69	99F-513P	2 in. / DN 50 CL300 FF	99-512P	37,950,000	427	2 in. FNPT	5 to 15	0.34 to 1.0	15	1.0	99F-512P	2 in. / DN 50 CL300 FF	99-515P	41,112,000	463	2 in. FNPT	10 to 20	0.69 to 1.4	20	1.4	99F-515P	2 in. / DN 50 CL300 FF	99-903P	44,275,000	498	2 in. FNPT	10 to 65	0.69 to 4.5	30	2.1	99F-903P	2 in. / DN 50 CL300 FF	99-502PH	50,600,000	570	1-1/8	29	2 in. FNPT	1 to 5	69 mbar to 0.34	5	0.34	300	20.7	99F-502PH	2 in. / DN 50 CL300 FF	99-503PH	61,668,000	694	2 in. FNPT	2 to 10	0.14 to 0.69	10	0.69	99F-503PH	2 in. / DN 50 CL300 FF	99-504PH	63,250,000	712	2 in. FNPT	5 to 15	0.34 to 1.0	15	1.0	99F-504PH	2 in. / DN 50 CL300 FF	99-505PH	67,993,000	765	2 in. FNPT	10 to 20	0.69 to 1.4	20	1.4	99F-505PH	2 in. / DN 50 CL300 FF	99-901PH	74,318,000	837	2 in. FNPT
99-511P	33,206,000	374			2 in. FNPT	1 to 5	69 mbar to 0.34	5	0.34																																																																																																				
99F-511P					2 in. / DN 50 CL300 FF							99-513P	36,368,000	409	2 in. FNPT	2 to 10	0.14 to 0.69	10	0.69	99F-513P	2 in. / DN 50 CL300 FF	99-512P	37,950,000	427	2 in. FNPT	5 to 15	0.34 to 1.0	15	1.0	99F-512P	2 in. / DN 50 CL300 FF	99-515P	41,112,000	463	2 in. FNPT	10 to 20	0.69 to 1.4	20	1.4	99F-515P	2 in. / DN 50 CL300 FF	99-903P	44,275,000	498	2 in. FNPT	10 to 65	0.69 to 4.5	30	2.1	99F-903P	2 in. / DN 50 CL300 FF	99-502PH	50,600,000	570	1-1/8	29	2 in. FNPT	1 to 5	69 mbar to 0.34	5	0.34	300	20.7	99F-502PH			2 in. / DN 50 CL300 FF	99-503PH	61,668,000	694	2 in. FNPT			2 to 10	0.14 to 0.69	10	0.69	99F-503PH	2 in. / DN 50 CL300 FF	99-504PH	63,250,000	712	2 in. FNPT	5 to 15	0.34 to 1.0	15	1.0	99F-504PH	2 in. / DN 50 CL300 FF	99-505PH	67,993,000	765	2 in. FNPT	10 to 20	0.69 to 1.4	20	1.4	99F-505PH	2 in. / DN 50 CL300 FF	99-901PH	74,318,000	837	2 in. FNPT	10 to 65	0.69 to 4.5	30	2.1	99F-901PH	2 in. / DN 50 CL300 FF
99-513P	36,368,000	409			2 in. FNPT	2 to 10	0.14 to 0.69	10	0.69																																																																																																				
99F-513P					2 in. / DN 50 CL300 FF							99-512P	37,950,000	427	2 in. FNPT	5 to 15	0.34 to 1.0	15	1.0	99F-512P	2 in. / DN 50 CL300 FF	99-515P	41,112,000	463	2 in. FNPT	10 to 20	0.69 to 1.4	20	1.4	99F-515P	2 in. / DN 50 CL300 FF	99-903P	44,275,000	498	2 in. FNPT	10 to 65	0.69 to 4.5	30	2.1	99F-903P	2 in. / DN 50 CL300 FF	99-502PH	50,600,000	570	1-1/8	29	2 in. FNPT	1 to 5	69 mbar to 0.34	5	0.34	300	20.7	99F-502PH			2 in. / DN 50 CL300 FF	99-503PH	61,668,000	694	2 in. FNPT			2 to 10			0.14 to 0.69	10	0.69	99F-503PH	2 in. / DN 50 CL300 FF			99-504PH	63,250,000	712	2 in. FNPT	5 to 15	0.34 to 1.0	15	1.0	99F-504PH	2 in. / DN 50 CL300 FF	99-505PH	67,993,000	765	2 in. FNPT	10 to 20	0.69 to 1.4	20	1.4	99F-505PH	2 in. / DN 50 CL300 FF	99-901PH	74,318,000	837	2 in. FNPT	10 to 65	0.69 to 4.5	30	2.1	99F-901PH	2 in. / DN 50 CL300 FF						
99-512P	37,950,000	427			2 in. FNPT	5 to 15	0.34 to 1.0	15	1.0																																																																																																				
99F-512P					2 in. / DN 50 CL300 FF							99-515P	41,112,000	463	2 in. FNPT	10 to 20	0.69 to 1.4	20	1.4	99F-515P	2 in. / DN 50 CL300 FF	99-903P	44,275,000	498	2 in. FNPT	10 to 65	0.69 to 4.5	30	2.1	99F-903P	2 in. / DN 50 CL300 FF	99-502PH	50,600,000	570	1-1/8	29	2 in. FNPT	1 to 5	69 mbar to 0.34	5	0.34	300	20.7	99F-502PH			2 in. / DN 50 CL300 FF	99-503PH	61,668,000	694	2 in. FNPT			2 to 10			0.14 to 0.69	10	0.69	99F-503PH	2 in. / DN 50 CL300 FF			99-504PH			63,250,000	712	2 in. FNPT	5 to 15	0.34 to 1.0			15	1.0	99F-504PH	2 in. / DN 50 CL300 FF	99-505PH	67,993,000	765	2 in. FNPT	10 to 20	0.69 to 1.4	20	1.4	99F-505PH	2 in. / DN 50 CL300 FF	99-901PH	74,318,000	837	2 in. FNPT	10 to 65	0.69 to 4.5	30	2.1	99F-901PH	2 in. / DN 50 CL300 FF												
99-515P	41,112,000	463			2 in. FNPT	10 to 20	0.69 to 1.4	20	1.4																																																																																																				
99F-515P					2 in. / DN 50 CL300 FF							99-903P	44,275,000	498	2 in. FNPT	10 to 65	0.69 to 4.5	30	2.1	99F-903P	2 in. / DN 50 CL300 FF	99-502PH	50,600,000	570	1-1/8	29	2 in. FNPT	1 to 5	69 mbar to 0.34	5	0.34	300	20.7	99F-502PH			2 in. / DN 50 CL300 FF	99-503PH	61,668,000	694	2 in. FNPT			2 to 10			0.14 to 0.69	10	0.69	99F-503PH	2 in. / DN 50 CL300 FF			99-504PH			63,250,000	712	2 in. FNPT	5 to 15	0.34 to 1.0			15			1.0	99F-504PH	2 in. / DN 50 CL300 FF	99-505PH	67,993,000			765	2 in. FNPT	10 to 20	0.69 to 1.4	20	1.4	99F-505PH	2 in. / DN 50 CL300 FF	99-901PH	74,318,000	837	2 in. FNPT	10 to 65	0.69 to 4.5	30	2.1	99F-901PH	2 in. / DN 50 CL300 FF																		
99-903P	44,275,000	498			2 in. FNPT	10 to 65	0.69 to 4.5	30	2.1																																																																																																				
99F-903P					2 in. / DN 50 CL300 FF							99-502PH	50,600,000	570	1-1/8	29	2 in. FNPT	1 to 5	69 mbar to 0.34	5	0.34	300	20.7	99F-502PH			2 in. / DN 50 CL300 FF	99-503PH	61,668,000	694	2 in. FNPT			2 to 10			0.14 to 0.69	10	0.69	99F-503PH	2 in. / DN 50 CL300 FF			99-504PH			63,250,000	712	2 in. FNPT	5 to 15	0.34 to 1.0			15			1.0	99F-504PH	2 in. / DN 50 CL300 FF	99-505PH	67,993,000			765			2 in. FNPT	10 to 20	0.69 to 1.4	20	1.4			99F-505PH	2 in. / DN 50 CL300 FF	99-901PH	74,318,000	837	2 in. FNPT	10 to 65	0.69 to 4.5	30	2.1	99F-901PH	2 in. / DN 50 CL300 FF																								
99-502PH	50,600,000	570	1-1/8	29	2 in. FNPT	1 to 5	69 mbar to 0.34	5	0.34	300	20.7																																																																																																		
99F-502PH					2 in. / DN 50 CL300 FF							99-503PH	61,668,000	694			2 in. FNPT	2 to 10	0.14 to 0.69	10	0.69			99F-503PH			2 in. / DN 50 CL300 FF	99-504PH	63,250,000	712	2 in. FNPT			5 to 15			0.34 to 1.0	15	1.0	99F-504PH	2 in. / DN 50 CL300 FF			99-505PH			67,993,000	765	2 in. FNPT	10 to 20	0.69 to 1.4			20			1.4	99F-505PH	2 in. / DN 50 CL300 FF	99-901PH	74,318,000			837	2 in. FNPT	10 to 65	0.69 to 4.5	30	2.1	99F-901PH	2 in. / DN 50 CL300 FF																																						
99-503PH	61,668,000	694			2 in. FNPT	2 to 10	0.14 to 0.69	10	0.69																																																																																																				
99F-503PH					2 in. / DN 50 CL300 FF							99-504PH	63,250,000	712			2 in. FNPT	5 to 15	0.34 to 1.0	15	1.0			99F-504PH			2 in. / DN 50 CL300 FF	99-505PH	67,993,000	765	2 in. FNPT			10 to 20			0.69 to 1.4	20	1.4	99F-505PH	2 in. / DN 50 CL300 FF			99-901PH			74,318,000	837	2 in. FNPT	10 to 65	0.69 to 4.5			30	2.1	99F-901PH	2 in. / DN 50 CL300 FF																																																				
99-504PH	63,250,000	712			2 in. FNPT	5 to 15	0.34 to 1.0	15	1.0																																																																																																				
99F-504PH					2 in. / DN 50 CL300 FF							99-505PH	67,993,000	765			2 in. FNPT	10 to 20	0.69 to 1.4	20	1.4			99F-505PH			2 in. / DN 50 CL300 FF	99-901PH	74,318,000	837	2 in. FNPT			10 to 65			0.69 to 4.5	30	2.1	99F-901PH	2 in. / DN 50 CL300 FF																																																																				
99-505PH	67,993,000	765			2 in. FNPT	10 to 20	0.69 to 1.4	20	1.4																																																																																																				
99F-505PH					2 in. / DN 50 CL300 FF							99-901PH	74,318,000	837			2 in. FNPT	10 to 65	0.69 to 4.5	30	2.1			99F-901PH			2 in. / DN 50 CL300 FF																																																																																		
99-901PH	74,318,000	837			2 in. FNPT	10 to 65	0.69 to 4.5	30	2.1																																																																																																				
99F-901PH					2 in. / DN 50 CL300 FF																																																																																																								

1. Capacity based on inlet pressure 20 psig / 1.4 bar greater than outlet pressure, external registration and 0.1 to 0.3 psi / 6.9 to 21 mbar proportional band. NOTE: Additional spring ranges and body styles are available. Ask your LPG Equipment distributor for more information.



**Type 1098** - The Type 1098-EGR regulator provides large capacities for use in large commercial applications and large distributed community systems. Designed to handle loads from 170,000,000 BTU / 1910 SCM (2 in. size) to in excess of 1,000,000,000 BTU / 11,234 SCM (4 in. size) and rated to 75 psig / 5.2 bar for Maximum Outlet Pressure, the Type 1098H is a regulator unmatched in performance in the LPG Industry. The Type 1098's pilot-operated two-path system is designed to quickly respond to sudden changes in the downstream demand, making this regulator ideal for fuel gas supply to industrial boilers, furnaces, ovens and mixers. Temperature rating for the Type 1098 is -20 to 180°F / -29 to 82°C. Actuator/diaphragm are size 40.

**Type 1098H** - The Type 1098H-EGR regulator also provides large capacities used in systems similar to Type 1098. The Type 1098H uses a special cast iron actuator assembly that increases the Maximum Downstream Pressure rating of the standard Type 1098 up to 300 psig / 20.7 bar, offering an even greater level of protection with outlet pressure settings up to 125 psig / 8.6 bar. Temperature rating for the Type 1098H is -20 to 180°F / -29 to 82°C. Actuator/diaphragm are size 30.

**Flanged Bodies** - The Types 1098 and 1098H are available with flanged bodies. Flanges are available in 2, 3 and 4 in. body sizes and CL300 FF end connection.

**Note: Type 1098 regulators do not have an internal relief and should be installed with additional/external overpressure protection. These units should not be installed as part of a two-stage system in fixed piping serving 14 in. w.c. / 35 mbar appliance systems unless additional overpressure protection is installed that will make the system compliant with NFPA 58 requirements for a two-stage system. Please consult with your LPG Equipment Distributor for more information.**



TYPE 1098-L22 PILOT-OPERATED REGULATOR

**Overpressure Protection** - The Types 1098 and 1098H is also available in monitor configurations. Note that the Type 1098H regulators may be used either as the worker or monitor regulator. For more information on monitor overpressure protection, see page 42.

The Type 1098 regulator is a highly advanced regulator with many configurations for various applications. **Always consult Emerson to discuss your application prior to placing your order.**

### Pilot-Operated High-Pressure Commercial/Industrial Regulators

TYPE	CAPACITIES (PROPANE)		ORIFICE SIZE		INLET AND OUTLET CONNECTION	OUTLET PRESSURE RANGE		OUTLET PRESSURE SETTING		MAXIMUM OPERATING INLET PRESSURE	
	BTU / hr	SCMH	In.	mm		psig	bar	psig	bar	psig	bar
1098-L21	170,500,000 <sup>(1)</sup>	1915 <sup>(1)</sup>	2-3/8	60	2 in. FNPT	2 to 10	0.14 to 0.69	10	0.69	400	27.6
1098-L22	215,300,000 <sup>(2)</sup>	2419 <sup>(2)</sup>				3 to 40	0.21 to 2.7	20	1.4		
1098-L23	322,300,000 <sup>(3)</sup>	3621 <sup>(3)</sup>				35 to 75	2.4 to 5.2	50	3.4		
1098-F21	170,500,000 <sup>(1)</sup>	1915 <sup>(1)</sup>			2 in. / DN 50 CL300 RF	2 to 10	0.14 to 0.69	10	0.69		
1098-F22	215,300,000 <sup>(2)</sup>	2419				3 to 40	0.21 to 2.7	20	1.4		
1098-F23	322,300,000 <sup>(3)</sup>	3621 <sup>(3)</sup>				35 to 75	2.4 to 5.2	50	3.4		
1098-F31	356,300,000 <sup>(1)</sup>	4003 <sup>(1)</sup>	3-3/8	86	3 in. / DN 80 CL300 RF	2 to 10	0.14 to 0.69	10	0.69		
1098-F32	447,400,000 <sup>(2)</sup>	5026 <sup>(2)</sup>				3 to 40	0.21 to 2.7	20	1.4		
1098-F33	669,500,000 <sup>(3)</sup>	7521 <sup>(3)</sup>				35 to 75	2.4 to 5.2	50	3.4		
1098-F41	551,300,000 <sup>(4)</sup>	6193 <sup>(4)</sup>	4-3/8	111	4 in. / DN 100 CL300 RF	2 to 10	0.14 to 0.69	10	0.69		
1098-F42	693,500,000 <sup>(4)</sup>	7791 <sup>(4)</sup>				3 to 40	0.21 to 2.7	20	1.4		
1098-F43	1,035,500,000 <sup>(3)</sup>	11,633 <sup>(3)</sup>				35 to 75	2.4 to 5.2	50	3.4		

NOTE: Additional spring ranges and body styles are available. Ask your LPG Equipment Distributor for more information.

- Capacity based on 30 psig / 2.1 bar inlet pressure and 15 psig / 1.0 bar setpoint.
- Capacity based on 40 psig / 2.8 bar inlet pressure and 20 psig / 1.4 bar setpoint.
- Capacity based on 75 psig / 5.2 bar inlet pressure and 50 psig / 3.4 bar setpoint.
- Capacity based on 25 psig / 1.7 bar inlet pressure greater than outlet pressure setting.

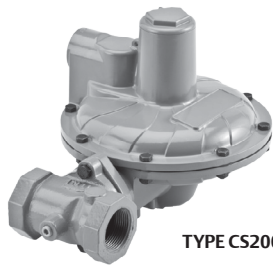

TYPE CS200

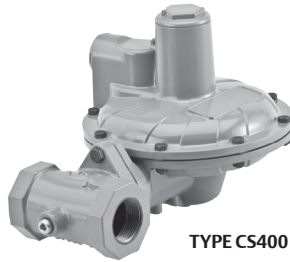

TYPE CS400



TYPE CS800

Emerson has a wide range of low-pressure regulators to meet almost any commercial or industrial application. For ease of reference, only the most popular commercial and industrial regulators are shown on this page. Other orifice sizes, body sizes and outlet pressure ranges are available. See the product guides on pages 36 and 38. The Commercial Service (CS) Regulator Series have a temperature rating of -20 to 160°F / -29 to 71°C, but have passed Fisher™ internal testing for lockup, relief start-to-discharge and reseal down to -40°F / -40°C.

**Note: Because of various spring ranges and orifice sizes, all commercial and industrial regulators should be individually sized for the particular installation. Consult specific product bulletins for maximum pressure ratings. Contact your local LPG Equipment Distributor for assistance.**

**Type CS400** – The Type CS400 is a medium capacity low-pressure, direct-operated regulator designed for loads up to 7,800,000 BTU per hour / 88 SCMH, ideal for installations at schools, bakeries and many other commercial/industrial applications. Available in 1-1/4, 1-1/2 and 2 in. body sizes with spring ranges from 4.5 in. w.c. to 5.5 psig / 11 mbar to 0.38 bar.

**Type CS200** – The Type CS200 is a medium capacity low-pressure, direct-operated regulator designed for loads up to 3,800,000 BTU per hour / 44 SCMH, ideal for installations on smaller commercial/industrial applications. Available in 3/4, 1 and 1-1/4 in. body sizes with spring ranges from 3.5 in. w.c. to 2 psig / 9 mbar to 0.14 bar.

**Flanged Bodies** – The Types CS400 and CS800 are available with a flanged body. Flanges are available in 2 in. / DN 50 body size and CL125 FF end connection.

**Type CS800** – The Type CS800 is a direct-operated, spring-loaded regulator which has been engineered for low-pressure commercial service applications. This regulator can accommodate up to 21,600,000 BTU per hour / 243 SCMH of flow capacity and is available in 1-1/2 and 2 in. body sizes with 8 in. w.c. to 5.5 psig / 20 mbar to 0.38 bar pressure ranges.

**Note: Types CS200, CS400 and CS800 regulators should be installed with additional/external overpressure protection. These units when installed as part of a two-stage system in fixed piping serving 14 in. w.c. / 35 mbar appliance systems require additional overpressure protection to make the system compliant with NFPA 58 requirements for a two-stage system. Please consult with your LPG Equipment Distributor for more information.**

### Low-Pressure Commercial Regulators

TYPE	CAPACITIES (PROPANE) <sup>(1)</sup>		ORIFICE SIZE		INLET AND OUTLET CONNECTION, IN.	OUTLET PRESSURE RANGE		OUTLET PRESSURE SETTING		MAXIMUM OPERATING INLET PRESSURE	
	BTU / hr	SCMH	In.	mm		psig	bar	psig	bar	psig	bar
CS200IR-6EC1	2,500,000	28	1/2	13	3/4 FNPT	10 to 14 in. w.c.	25 to 35 mbar	11 in. w.c.	27 mbar	40	2.8
CS200IR-6EC3	3,800,000	43			1 FNPT						
CS200IR-6EC6	3,900,000	44			1-1/4 FNPT						
CS400IR-8EC6	6,800,000	76	3/4	19.1	1-1/4 FNPT	8 to 12 in. w.c.	20 to 30 mbar	2	0.14	20	1.4
CS400IR-8EC7	7,600,000	85			1-1/2 FNPT						
CS400IR-8EC8	7,600,000	85			2 FNPT						
CS800IR-8CC7	10,460,000	118	1	25.4	1-1/2 FNPT	1 to 2	0.06 to 0.14	2	0.14	30	2.1
CS800IR-8CC8	21,809,000	245			2 FNPT						
CS200IR-6HC1	3,760,000	42	1/2	13	3/4 FNPT	1 to 2.5	0.06 to 0.17	5	0.35	40	2.8
CS200IR-6HC3	4,780,000	54			1 FNPT						
CS200IR-6HC6	5,327,000	60			1-1/4 FNPT						
CS400IR-8HC6	9,715,000	109	3/4	19.1	1-1/4 FNPT	2 to 5.5	0.14 to 0.38	5	0.35	20	1.4
CS400IR-8HC7	10,500,000	118			1-1/2 FNPT						
CS400IR-8HC8	8,775,000	99			2 FNPT						
CS820IR-8FC7	15,011,000	169	1	25.4	1-1/2 FNPT	2.5 to 5.5	0.17 to 0.38	5	0.35	30	2.1
CS820IR-8FC8	21,436,000	241			2 FNPT						
CS400IR-8IC6	7,365,000	83	3/4	19.1	1-1/4 FNPT	1 to 2	0.06 to 0.14	2	0.14	40	2.8
CS400IR-8IC7	6,895,000	77			1-1/2 FNPT						
CS400IR-8IC8	7,365,000 <sup>(2)</sup>	83 <sup>(2)</sup>			2 FNPT						
CS820IR-8HC7	15,262,000	171	1	25.4	1-1/2 FNPT	2.5 to 5.5	0.17 to 0.38	5	0.35	30	2.1
CS820IR-8HC8	16,532,000	186			2 FNPT						

1. Capacities are based on 10 psig / 0.69 bar and 2 in. w.c. / 5 mbar droop.

2. Capacities are based on 10 psig / 0.69 bar and 20% droop.

NOTE: Additional combinations of body sizes, spring ranges and orifice sizes are available. See guides on the next page. Consult your LPG Equipment distributor for more information.

Type CS200 Selection Guide													
BASE		SENSING		RELIEF		ORIFICE		REGULATOR SETPOINT		BODY OPTION			
CODE	DESCRIPTION	CODE	DESCRIPTION	CODE	DESCRIPTION	CODE	SIZE In. / mm	CODE	In. w.c. / mbar	CODE	DESCRIPTION		
CS200	Basic	I	Internal	N	None	1	1/8 / 3.2	A	3.5 to 5 / 9 to 12	C1	3/4 in. FNPT, Cast Iron		
					Internal	2	3/16 / 4.8	B	4.5 to 6.5 / 11 to 16	C3	1 in. FNPT, Cast Iron		
								3	1/4 / 6.4	C	6 to 8 / 15 to 20	C6	1-1/4 in. FNPT, Cast Iron
								5	3/8 / 9.5	D	7.5 to 11 / 19 to 27		
								6	1/2 / 13	E	10 to 14 / 25 to 35		
										F	12 to 19 / 30 to 47		
										G	18 to 1 psig / 45 mbar to 0.06 bar		
										H	1 to 2 psig / 0.06 to 0.13 bar		

Type CS400 Selection Guide											
BASE		SENSING		RELIEF		ORIFICE		REGULATOR SETPOINT		BODY OPTION	
CODE	DESCRIPTION	CODE	DESCRIPTION	CODE	DESCRIPTION	CODE	SIZE, In. / mm	CODE	In. w.c. / mbar	CODE	DESCRIPTION
CS400	Basic	I	Internal	N	None	2	3/16 / 4.8	A	3.5 to 5 / 9 to 12	C6	1-1/4 in. FNPT, Cast Iron
					Internal	3	1/4 / 6.4	B	4.5 to 6.5 / 11 to 16	C7	1-1/2 in. FNPT, Cast Iron
						T	Token	5	3/8 / 9.5	C	6 to 8 / 15 to 20
						6	1/2 / 13	D	7.5 to 11 / 19 to 27	C9	2 in. / DN 50, CL150 FF, Ductile Iron
						8	3/4 / 19	E	10 to 14 / 25 to 35		
								F	12 to 19 / 30 to 47		
								G	18 to 1 psig / 45 mbar to 0.06 bar		
								H	1 to 2 psig / 0.06 to 0.13 bar		
						I	2 to 5.5 psig / 0.14 to 0.38				

Type CS800 Selection Guide											
BASE		SENSING		RELIEF		ORIFICE		REGULATOR SETPOINT		BODY OPTION	
CODE	DESCRIPTION	CODE	DESCRIPTION	CODE	DESCRIPTION	CODE	SIZE, In. / mm	CODE <sup>(1)</sup>	In. w.c. / mbar	CODE	DESCRIPTION
CS800	Basic	I	Internal	N	None	2	1/4 / 6.4	A	3.5 to 6 / 9 to 15	C6	1-1/4 in. FNPT, Gray Iron
CS820	High Outlet	E	External	R	Internal	3	3/8 / 9.5	B	5.5 to 8.5 / 11 to 16	C7	1-1/2 in. FNPT, Gray Iron
					Token	4	1/2 / 13	C	8 to 12 / 15 to 20	C8	2 in. FNPT, Gray Iron
					High Capacity	6	3/4 / 19.1	D	10 to 16 / 25 to 40	C9	2 in. / DN 50, CL125 FF, Gray Iron
						8	1 / 25	E	14 to 30 / 25 to 75	D11	2 in. / DN 50, CL150 FF, Ductile Iron
						9	1-3/8 / 35	F	1 to 2.5 psig / 0.06 to 0.17 bar		
										G	1.5 to 3.5 / 0.10 to 0.24 bar
						H	2.5 to 5.5 / 0.17 to 0.38 bar				

1. Code A to E only applies to Type CS800. Code F to H only applies to Type CS820.

### Type CS403 with Integral True-Monitor™ Protection

1-1/4 in. FNPT to 2 in. FNPT Body Sizes  
 (2 in. / DN 50, CL150 Flange Available)  
 7.65 to 8.44M BTU per hour / 85.9 to 94.8 SCMH  
 Internal Registration

**Type CS403:** Combines operation of a conventional two-regulator wide-open monitor set into one body. During normal operation, the monitor is in a wide open state at a setpoint higher than the primary regulator. If the downstream pressure should rise due to loss of control by the primary regulator, the integral monitor will assume control and regulate the flow to the downstream system.

See Selection Guide on the next page for available options.

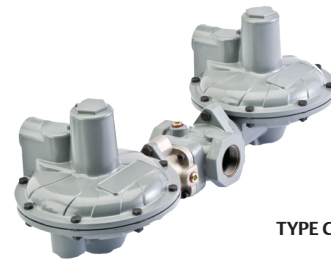

TYPE CS403

PRIMARY SETPOINT	MONITOR SETPOINT	MONITOR SPRING RANGE
In. w.c. / mbar	In. w.c. / mbar	Spring Range
11 / 27	21 / 52	16 to 23 in. w.c. / 40 to 57 mbar
2 psig / 0.14 bar	2.5 psig / 0.17 bar	1.5 to 2.5 psig / 0.10 to 0.17 bar
5 psig / 0.35 bar	6 psig / 0.41 bar	4 to 7.5 psig / 0.28 to 0.52 bar

### Type CS404 with Integral Slam shut

1-1/4 in. FNPT to 2 in. FNPT Body Sizes  
 (2 in. / DN 50, CL150 Flange Available)  
 7.65 to 8.44M BTU per hour / 85.9 to 94.8 SCMH  
 Internal Registration

**Type CS404:** Integrates a fast acting shutoff device that provides overpressure shutoff (OPSO) or over/underpressure shutoff (UPS/O) protection by completely shutting off the flow of gas to the downstream system. The Slam Shut operates independently of the main regulator and does not affect normal operation unless the downstream pressure fluctuates outside of the desired ranges.

See Selection Guide on the next page for available options.

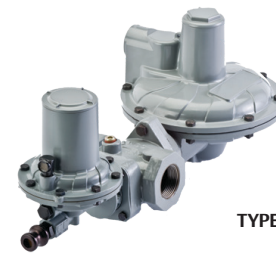

TYPE CS404

PRIMARY SETPOINT	SLAM-SHUT SETPOINT	
	OPSO	UPS/O - OPSO
In. w.c. / mbar	In. w.c. / mbar	In. w.c. / mbar
7 / 17	17 / 42	----
11 / 27	19 / 47	6.3 / 16 - 25 / 62
14 / 35	30 / 75	8.8 / 22 - 28 / 70
1 psig / 0.07 bar	1.9 psig / 0.13 bar	16 / 40 - 1.9 psig / 0.13 bar
2 psig / 0.14 bar	3.3 psig / 0.23 bar	1 psig / 0.07 bar - 3.2 psig / 0.22 bar
5 psig / 0.35 bar	6.7 psig / 0.46 bar	2.9 psig / 0.20 bar - 7.5 psig / 0.52 bar

### Types CS803 and CS823 with Integral True-Monitor Protection

1-1/2 in. FNPT and 2 in. FNPT Body Sizes  
 (2 in. / DN 50, CL150 Flange Available)  
 10.46 to 21.44M BTU per hour / 118 to 241 SCMH  
 Internal Registration

**Type CS803:** Designed to deliver less than 1 psig, the Type CS803 combines operation of a conventional two-regulator wide-open monitor set into one body. During normal operation, the monitor is in a wide open state at a setpoint higher than the primary regulator. If the downstream pressure should rise due to loss of control by the primary regulator, the integral monitor will assume control and regulate the flow to the downstream system.

**Type CS823:** Equipped with the same technology as the Types CS803 and Type CS823 delivers up to 5.5 psig / 0.38 bar operating pressures.

See Selection Guide on the next page for available options.

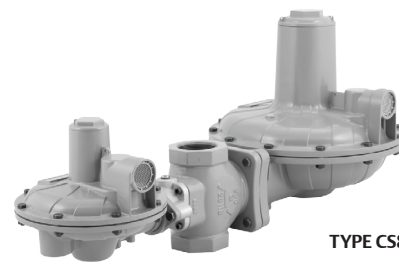

TYPE CS803

PRIMARY SETPOINT	MONITOR SETPOINT	MONITOR SPRING RANGE
In. w.c. / mbar	In. w.c. / mbar	Spring Range
11 / 27	21 / 52	16 to 23 in. w.c. / 40 to 57 mbar
2 psig / 0.14 bar	2.5 psig / 0.17 bar	1.5 to 2.5 psig / 0.10 to 0.17 bar
5 psig / 0.35 bar	6 psig / 0.41 bar	4 to 7.5 psig / 0.28 to 0.52 bar

Type CS403 Selection Guide											
BASE		SENSING		RELIEF		ORIFICE		REGULATOR SETPOINT		BODY OPTION	
CODE	DESCRIPTION	CODE	DESCRIPTION	CODE	DESCRIPTION	CODE	SIZE, In. / mm	CODE	Primary - Monitor In. w.c. / mbar	CODE	DESCRIPTION
CS403	Integral Monitor	I	Internal	N	None	2	3/16 / 4.8	D	11 / 27 - 21 / 52	D2	1-1/4 in. FNPT, Ductile Iron
		E	External	T	Token	3	1/4 / 6.4	H	2 psig / 0.14 bar - 2.5 psig / 0.17 bar	D3	1-1/2 in. FNPT, Ductile Iron
						5	3/8 / 9.5	L	5 psig / 0.35 bar - 6 psig / 0.41 bar	D4	2 in. FNPT, Ductile Iron
						6	1/2 / 13			D9	2 in. / DN 50, CL125 FF, Ductile Iron
						8	3/4 / 19				

Type CS404 Selection Guide											
BASE		SENSING		RELIEF		ORIFICE		REGULATOR SETPOINT		BODY OPTION	
CODE	DESCRIPTION	CODE	DESCRIPTION	CODE	DESCRIPTION	CODE	SIZE, In. / mm	CODE	Primary - Slam shut In. w.c. / mbar	CODE	DESCRIPTION
CS404	Integrated Slam shut	I	Internal	N	None	2	3/16 / 4.8	D	11 / 27 - 19 / 47	D2	1-1/4 in. FNPT, Ductile Iron
		E	External	T	Token	3	1/4 / 6.4	K	2 psig / 0.14 bar - 3.3 psig / 0.23 bar	D3	1-1/2 in. FNPT, Ductile Iron
						5	3/8 / 9.5	N	5 psig / 0.35 bar - 6.7 psig / 0.46 bar	D4	2 in. FNPT, Ductile Iron
						6	1/2 / 13	V*	11 in. w.c. / 27 mbar - 6.3 in. w.c. / 16 mbar - 25 in. w.c. / 62 mbar	D9	2 in. / DN 50, CL125 FF, Ductile Iron
						8	3/4 / 19	AB*	2 / 0.14 - 1 / 0.06 - 3.2 / 0.22		
						AE*	5 / 0.35 - 2.9 / 0.2 - 7.5 / 0.52				

\* set pressures for:  
Primary - Underpressure - Overpressure. Units are in psig / bar

Types CS803 and CS823 Selection Guide											
BASE		SENSING		RELIEF		ORIFICE		REGULATOR SETPOINT		BODY OPTION	
CODE	DESCRIPTION	CODE	DESCRIPTION	CODE	DESCRIPTION	CODE	SIZE In. / mm	CODE	In. w.c. / mbar	CODE	DESCRIPTION
CS803	Integral Monitor, in. w.c.	I	Internal	N	None	2	1/4 / 6.4	D	11 / 27	D3	1 1/2 in. FNPT, Ductile Iron
CS823	Integral Monitor, psig	E	External	T	Token	3	3/8 / 9.5	H	2 psig / 0.14 bar	D4	2 in. FNPT, Ductile Iron
						5	1/2 / 13	L	5 psig / 0.35 bar	D9	2 in. CL125 FF/ CL150 FF Cast Iron
						6	3/4 / 19				
						8	1 / 25				

# Industrial Service Low-Pressure Regulators

## Regulators



TYPE 133H  
OR 133L



TYPE 299H

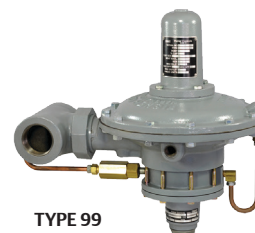

TYPE 99

Emerson has a wide range of low-pressure regulators to meet almost any commercial or industrial application. For ease of reference, only the most popular commercial and industrial regulators are shown on this page. Other orifice sizes, body sizes and outlet pressure ranges are available.

**Note: Because of various spring ranges and orifice sizes, all commercial and industrial regulators should be individually sized for the particular installation. Consult specific product bulletins for maximum pressures ratings. Contact your local LPG Equipment Distributor for assistance.**

**Type 299H** – A high capacity pilot-operated regulator. Incorporates a lightweight design (21 lbs / 10 kg) with dependable operation. With a capacity up to 38,000 000 BTU per hour / 428 SCMH, the Type 299H is ideal for applications from large commercial sites to smaller multi-dwelling establishments. The unit comes with a 1-1/2 or 2 in. cast iron body with internal or external registration. Internal registration allows easy installation while external registration provides higher accuracy. 2 in. / DN 50 flanged body or steel body material also available. Alternate

outlet settings from 3.5 in. w.c. to 60 psig / 9 mbar to 4.1 bar are available. Temperature ratings for the Type 299H is -20 to 150°F / -29 to 66°C. **The Type 299H has maximum inlet pressure rating of 150 psig / 10 bar so it cannot be used as a First-Stage regulator.**

**Type 99** – Pilot-operated unit keeps outlet pressure constant despite varying flow rates and inlet pressures. Designed to handle loads up to 63,250,000 BTU per hour / 712 SCMH, the Type 99L is ideal for multiple customer installations. The unique pilot design, with fast opening and closing operation, makes the Type 99L ideal for large industrial boiler applications. The Type 99L can be used for low pressure. A downstream control line is required. Temperature ratings for the Type 99 is -20 to 160°F / -29 to 82°C.

**133 Series** – Direct-operated Second-Stage regulator ideal for large industrial applications with loads up to 70,875,000 BTU per hour / 798 SCMH. The unit can be used for either low pressure or pounds service. Maximum inlet pressure is 60 psig / 4.1 bar and a downstream control line is required. The 133 Series has a temperature rating of -20 to 150°F / -29 to 66°C.

### Low-Pressure Commercial/Industrial Regulators

TYPE	CAPACITIES (PROPANE)		ORIFICE SIZE		INLET AND OUTLET CONNECTION, IN.	OUTLET PRESSURE RANGE		OUTLET PRESSURE SETTING		MAXIMUM OPERATING INLET PRESSURE	
	BTU / hr	SCMH	In.	mm		psig	bar	psig	bar	psig	bar
299H-101	13,100,000 <sup>(1)</sup>	148 <sup>(1)</sup>	3/4	19	1-1/2 FNPT	9 to 20 in. w.c.	22 to 50 mbar	11 in. w.c.	27 mbar	150	10.3
299H-102	19,700,000 <sup>(1)</sup>	222 <sup>(1)</sup>			2 FNPT						
299H-103	23,300,000 <sup>(2)</sup>	262 <sup>(2)</sup>			1-1/2 FNPT	6 to 16	0.41 to 1.1	10	0.69		
299H-104	38,000,000 <sup>(2)</sup>	428 <sup>(2)</sup>			2 FNPT						
299H-105	20,400,000 <sup>(3)</sup>	230 <sup>(3)</sup>			1-1/2 FNPT	9 to 20 in. w.c.	22 to 50 mbar	11 in. w.c.	27 mbar		
299H-106					2 FNPT						
299H-107	38,000,000 <sup>(4)</sup>	428 <sup>(4)</sup>			1-1/2 FNPT	6 to 16	0.41 to 1.1	10	0.69		
299H-108					2 FNPT						
99-501P	49,000,000 <sup>(6)</sup>	552 <sup>(6)</sup>	1-1/8	29	2 FNPT	7 in. w.c. to 2 psig	17 mbar to 0.14 bar	1	69 mbar	150	10.3
99-502P	50,600,000 <sup>(6)</sup>	570 <sup>(6)</sup>				1 to 5	69 mbar to 0.34 bar	5	0.34		
99-503P	61,650,000 <sup>(6)</sup>	694 <sup>(6)</sup>				2 to 10	0.14 to 0.69	10	0.69		
99-504P	63,250,000 <sup>(6)</sup>	712 <sup>(6)</sup>				5 to 15	0.34 to 1.0	15	1.0		
133L-4	70,875,000 <sup>(3)</sup>	798 <sup>(3)</sup>	2	51		8.5 to 18 in. w.c.	21 to 45 mbar	14 in. w.c.	35 mbar	60	4.1
133H-1	66,150,000 <sup>(5)</sup>	745 <sup>(5)</sup>				1.5 to 3	0.10 to 0.21	3	0.21		
133H-3	115,958,000 <sup>(6)</sup>	1305 <sup>(6)</sup>				5 to 10	0.34 to 0.69	10	0.69		

1. Capacity based on inlet pressure of 10 psig / 0.69 bar, Internal Registration and 2 in. w.c. / 5 mbar droop.  
 2. Capacity based on inlet pressure of 20 psig / 1.4 bar higher than outlet pressure, Internal Registration and 20% droop.  
 3. Capacity based on inlet pressure of 10 psig / 0.69 bar, External Registration and 2 in. w.c. / 5 mbar droop.  
 4. Capacity based on inlet pressure of 20 psig / 1.4 bar higher than outlet pressure, External Registration and 2 in. w.c. / 5 mbar droop.  
 5. Capacity based on inlet pressure of 10 psig / 0.69 bar, External Registration and 20% droop.  
 6. Capacity based on inlet pressure of 20 psig / 1.4 bar higher than outlet pressure, External Registration and 20% droop.  
 NOTE: Additional spring ranges and body styles are available. Ask your LPG Equipment Distributor for more information.

## Commercial Automatic Changeover Regulators

Designed for large capacity multi-cylinder or tank installations, these regulators are used on applications such as bakeries, motels, restaurants and grain dryers. The manifold portion of the assembly consists of two 64 Series regulators and a direct mounted 803 Series indicator. Temperature rating for the Type 64SR-122 is -20 to 150°F / -29 to 66°C.

**Type 64SR-122** – For high pressure (pounds-to-pounds) service with the outlet pressure supplied by a Type 64SR that has internal relief protection.



TYPE 64SR-122

Commercial Automatic Changeover Regulators					
TYPE	CAPACITIES IN BTU per hour / SCMH PROPANE <sup>(1)</sup>	INLET CONNECTION, IN.	OUTLET CONNECTION, IN.	OUTLET PRESSURE SETTING, psig / bar	OUTLET ADJUSTMENT RANGE, psig / bar
64SR-122	1,210,000 / 13.6	1/2 FNPT	1/2 FNPT	10 / 0.69	5 to 20 / 0.34 to 1.4

## Changeover Manifold Assemblies

**Type R130-21** – Composed of two Type 67C regulators and a special 0 to 60 psig / 0 to 4.1 bar pressure gauge, the Type R130 delivers a 45 psig / 3.1 bar outlet pressure on supply and 30 psig / 2.1 bar on reserve. The gauge, which serves as the changeover indicator, is painted red from 0 to 35 psig / 0 to 2.4 bar. When the dial reads in the 0 to 35 psig / 0 to 2.4 bar range, it indicates that the manifold has switched from the supply to the reserve cylinder. The Type R130-21 has a temperature rating of -20 to 160°F / -29 to 71°C.

**Type 749B-21** – Large capacity changeover manifold for commercial and industrial applications. It consists of two 64 Series regulators and a 803 Series direct indicator. The assembly is used primarily in conjunction with either a Type HSRL or 64SR regulator. The standard outlet setting is 15 psig / 1.0 bar from the supply and 5 psig / 0.34 bar from the reserve. Temperature rating for the Type 749B-21 is -20 to 150°F / -29 to 66°C.

**Note:** These units are intended for use with Second-Stage regulators and/or separate relief devices which provide overpressure protection required by NFPA 58. Capacity of all these changeover manifolds is dependent on the size of the Second-Stage regulator with which they are used. If the manifolds are used as a Final-Stage (pounds-to-pounds), a relief valve is required in the downstream system.



TYPE R130-21

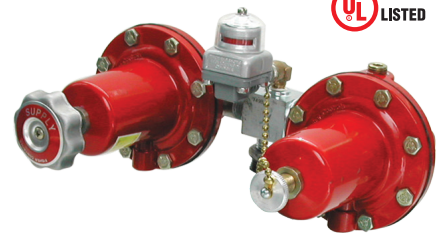

TYPE 749B-21



TYPE 803-21

## Remote Indicator

**803 Series** – give remote visual indication that the supply cylinder is empty and that the regulator is withdrawing gas from the reserve cylinder. The indicator has 360° visibility and is weatherproof.

**Type 803-21** – Indicator only

Changeover Manifold Regulators					
TYPE	CAPACITIES IN BTU per hour / SCMH PROPANE <sup>(1)</sup>	INLET CONNECTION, IN.	OUTLET CONNECTION, IN.	OUTLET PRESSURE SETTING	
				Supply Setting, psig / bar	Reserve Setting, psig / bar
R130-21	1,475,000 / 16.6	1/4 FNPT	1/4 FNPT	45 / 3.1	30 / 2.1
749B-21	1,500,000 / 16.9	1/2 FNPT	1/2 FNPT	15 / 1.0	5 / 0.34

1. Based on 100 psig / 6.9 bar inlet, reserve setting.

# Monitor Overpressure Protection Regulators

Monitoring is overpressure control by containment. When the working pressure reducing valve ceases to control the pressure, a second regulator installed in series, which has been sensing the downstream pressure, goes into operation to maintain the downstream pressure at a slightly higher than normal pressure. The monitoring concept is gaining in popularity, especially in low-pressure systems, because very accurate relay points permit reasonably close settings of the working and monitoring regulators.

When selecting regulators for use in a monitor system, the upstream regulator must have a control line. When determining the capacity of a monitor system you will get approximately 70% to 73% of the capacity of a single regulator when using the same regulator for both regulators in the system.

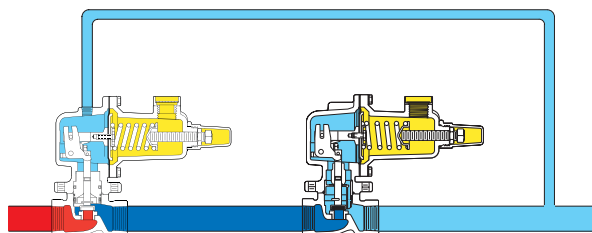

TYPE 627M (DIRECT-OPERATED) MONITOR

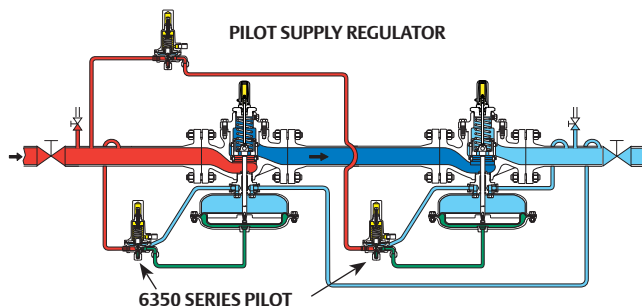

TYPE 1098H (PILOT-OPERATED) MONITOR

- INLET PRESSURE
- OUTLET PRESSURE
- LOADING PRESSURE
- ATMOSPHERIC PRESSURE
- INTERMEDIATE PRESSURE

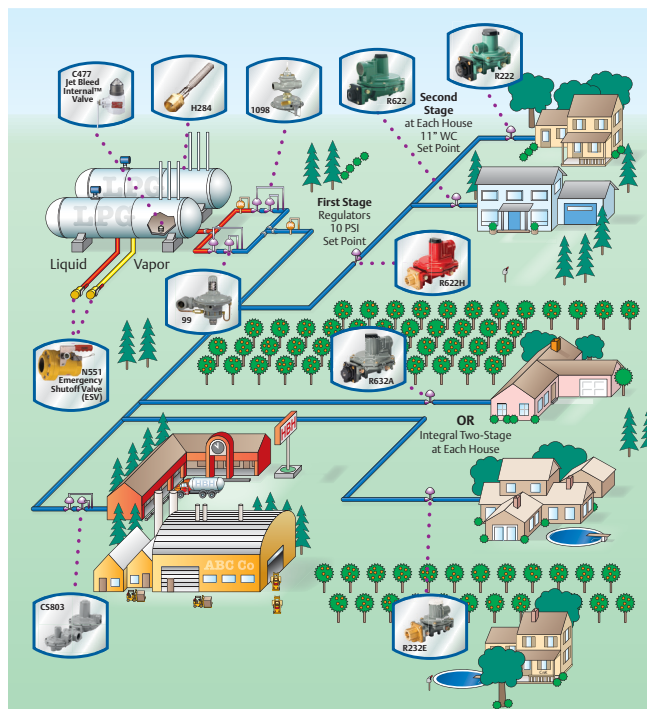

COMMUNITY SYSTEM MAP

The major advantage is that there is no venting to atmosphere. During an overpressure situation, monitoring keeps the customer on line and keeps the downstream pressure relatively close to the setpoint of the working regulator. Testing is relatively easy and safe. To perform a periodic test on a monitor, increase the outlet set pressure of the working device and watch the pressure to determine if the monitor takes over.

Fisher™ offers a wide variety of products for monitor applications. Provided for your reference below is a list of commonly used regulators for various capacity requirements. Note that pilot-operated regulators may be used in conjunction with direct-operated regulators in monitor applications, depending on the application requirement. Please call your local LPG Equipment Distributor to review your monitor requirements.

### Typical Wide-Open Monitor System

OPERATING REGULATOR	ORIFICE SIZE		BODY SIZE, IN.	MONITOR REGULATOR	ORIFICE SIZE		BODY SIZE, IN.	REGULATING CAPACITY <sup>(1)</sup>	
	In.	mm			In.	mm		BTU/hr	SCMH
Type 627-5810	3/8	9.53	3/4 NPT	Type 627M-421	1/2	13	3/4 NPT	5,750,000	64.6
Type 627-6210	1/2	13	3/4 NPT	Type 627M-421			3/4 NPT	7,050,000	79.2
Type 627-7710			1 NPT	Type 627M-471			1 NPT	8,400,000	94.4
Type 630-104/78			2 NPT	Type 627M-267			2 NPT	13,500,000	152
Type 630-104/78	1-1/8	28.6	2 NPT	Type 99M-504PH	1-1/8	28.6	2 NPT	42,650,000	479
Type 99-504PH			2 NPT	Type 99M-504PH			2 NPT	54,500,000	612
Type 99-504PH	2-3/8	60.3	2 NPT	Type 1098H	2-3/8	60.3	2 NPT	136,900,000	1538
Type 1098			3 NPT	Type 1098H			3 NPT	283,700,000	3187
Type 1098			4 NPT	Type 1098H			4 NPT	437,800,000	4918

1. Capacities are based on 30 psig / 2.1 bar in and 8 psig / 0.55 bar out.



### Relief Valve for Liquid or Vapor Service

**Type MR98H** – is a direct-operated relief valve for use on relief and backpressure applications involving large LPG pumping systems and vaporizers. Internal pressure registration eliminates the need for a control line. Body materials are available in Gray Cast Iron, Steel or Stainless Steel. It is available with Nitrile (NBR) gaskets in sizes from 1/4 in. to 2 in. / 6.35 to 50.8 mm. Relief pressure ranges from 15 to 200 psi / 1.03 to 13.8 bar. Temperature ratings are -40 to 180°F / -40 to 82°C for CI and SST and -20 to 180°F / -29 to 82°C for Steel. Available with: gauge port on inlet, gauge port on outlet and Fluorocarbon (FKM) elastomers.

**Type MR98HH** – Same features as above but relief pressure range is 150 to 375 psig / 10.3 to 25.9 bar.

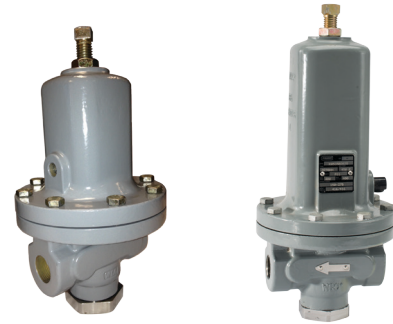

TYPE MR98H

TYPE MR98HH

### Liquid Service Relief Valves

TYPE	BODY SIZE, IN.	RELIEF PRESSURE RANGE		RELIEF PRESSURE SETTING		PROPANE RELIEF CAPACITY GPM / l/min AT FOLLOWING PRESSURE BUILD-UP OVER RELIEF SETTING									
		psig	bar	psig	bar	5 psig / 0.34 bar		10 psig / 0.69 bar		20 psig / 1.4 bar		30 psig / 2.1 bar		50 psig / 3.4 bar	
						GPM	l/min	GPM	l/min	GPM	l/min	GPM	l/min	GPM	l/min
MR98H-13	1/2 FNPT	25 to 75	1.7 to 5.2	50	3.4	16.9	66.1	26.8	103.4	38.0	140.8	40.8	154.9	49.3	184.5
MR98H-22	3/4 FNPT	70 to 140	4.8 to 9.7	100	6.9	32.4	121.0	53.5	201.4	78.9	300.0	87.3	331.0	104.2	394.4
MR98H-30	1 FNPT	70 to 140	4.8 to 9.7	100	6.9	32.4	121.0	53.5	201.4	78.9	300.0	87.3	331.0	104.2	394.4
MR98H-31	1 FNPT	130 to 200	9.0 to 13.8	175	12.1	29.6	112.4	47.9	178.9	77.5	291.5	90.1	342.3	118.3	446.5
MR98HH-19	1 FNPT	150 to 375	10.3 to 25.9	250	17.2	27.6	104.4	37.7	142.3	61.7	233.8	83.4	315.5	113.0	426.8

### Vapor Relief Valves

**Type 1805** – relief valve is designed for installation between the First and Second-Stage regulators or in the downstream line from a high-pressure regulator used for a Final-Stage service where high line pressures are allowed. Available in 1 or 2 in. valve bodies with a temperature rating of -20 to 150°F / -29 to 66°C.

**Type 289H** – relief valve is designed for installation downstream of larger high-pressure or low-pressure regulators in most all relief applications. The larger diaphragm in this relief valve provides extremely sensitive operation, with a temperature rating of -20 to 150°F / -29 to 66°C.

**Types 1808 and 1808A** – pilot-operated relief valve is designed to protect large high-pressure regulators by offering extremely high relief capacities compared to the Type 289H. The Type 1808 has a temperature rating of -20 to 180°F / -29 to 82°C.

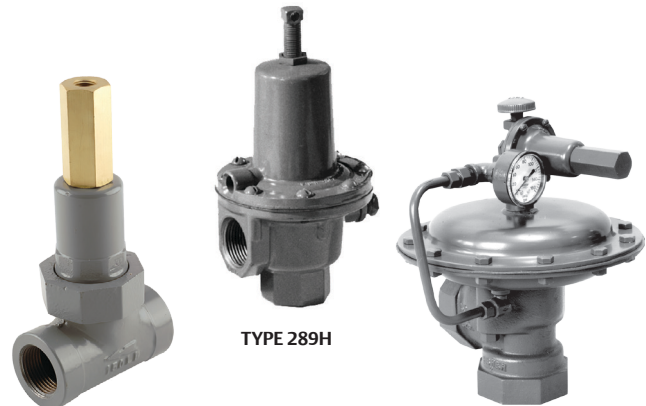

TYPE 1805

TYPE 289H

TYPE 1808

### Vapor Relief Valves

TYPE	BODY SIZE, IN.	RELIEF START-TO-DISCHARGE		SPRING RANGE		PRESSURE BUILDUP OVER SET PRESSURE		CAPACITY (AIR)	
		psig	bar	psig	bar	psig	bar	SCFH	Nm³/h
1805-18P	1 FNPT	15	1.03	5 to 35	0.34 to 2.41	15	1.03	6160 at 30 psig	161 at 2.07 bar
1805-19P	1 FNPT	40	2.75	10 to 60	0.69 to 4.1	15	1.03	3120 at 55 psig	83.62 at 3.79 bar
1805-51P	2 FNPT	15	1.03	5 to 20	0.34 to 1.38	15	1.03	28,500 at 30 psig	748 at 2.07 bar
1805-52P	2 FNPT	40	2.75	10 to 50	0.69 to 3.4	15	1.03	14,245 at 55 psig	381.77 at 3.79 bar
1808A-61	2 FNPT, Angle	20	1.4	15 to 40	1.03 to 2.76	10	0.69	78,230 at 30 psig	2053 at 2.07 bar
289H-42	1 FNPT	15	1.03	4 to 15	0.28 to 1.03	15	1.03	33,880 at 30 psig	889 at 2.07 bar
289H-2	2 FNPT	24 in. w.c.	60 mbar	1/2 to 2-1/4	34 to 155 mbar	1.13	78 mbar	15,400 at 2 psig	38 at 138 mbar

NOTE: Some regulators will require more than one relief valve. Consult your local Fisher™ LPG Distributor for proper relief valve sizing.



TYPE Y602-1 (UMBRELLA TYPE)



TYPE Y602-13 (ANGLE TYPE)

### Vent Assemblies

Attached directly to the regulator vent connection to a regulator vent line, vent assemblies should be pointed downward on outdoor installations to avoid moisture build-up in the regulator spring case. Units with stabilizer assembly are intended for regulators with stability problems. The stabilizer gives a restricted breathing rate under normal conditions, opening for rapid discharge when necessary. Screen material is Monel® with integral plastic screen for all except Type Y602-12.

Vent Assemblies			
TYPE		SIZE	STABILIZER
Umbrella Type	Angle Type		
----	Y602-13	1/4 in. FNPT	No
----	Y602-14		Yes
Y602-1	----	1/4 in. MNPT	No
Y602-2	----		Yes
Y602-3	----	3/8 in. O.D. Tubing (Flare Connection)	No
Y602-4	----		Yes
Y602-12	----	1/4 in. MNPT	No
----	Y602-5	3/8 in. FNPT	No
----	Y602-6		Yes
----	Y602-7	1/2 in. FNPT	No
----	Y602-8		Yes
----	Y602-9	3/4 in. FNPT	No
----	Y602-23	3/4 in. MNPT	No
----	Y602-25	1 in. MNPT	No



TYPE 912-101

### Small Portable Appliance Regulators

**Type 912** – Designed for use on small portable outdoor appliances.

**Underwriters Laboratory (UL®)** requires horizontally mounted regulators to be installed with vent opening protection to prevent blockage by freezing rain. The 912 Series has a temperature rating of -20 to 160°F / -29 to 71°C.

Appliance Regulators													
TYPE	PRESSURE RANGE		OUTLET PRESSURE		Capacities in BTU per hour Propane			INLET CONNECTION		OUTLET CONNECTION		ORIFICE SIZE	
	In. w.c.	mbar	In. w.c.	mbar	10 psig, Inlet	25 psig, Inlet	100 psig, Inlet	In.	mm	In.	mm	In.	mm
912N-194 <sup>(1)</sup>	3 to 7	7 to 17	5	12	101,000	151,000	----	1/4	6.4	1/4	6.4	0.073	1.85
912-104	9.25 to 13	23 to 32	11	27	101,000	270,000	349,000	1/4	6.4	1/4	6.4	0.073	1.85
912N-109 <sup>(1)</sup>	5 to 10	12 to 25	7	17	123,000	232,000	556,000	1/4	6.4	3/8	9.5	0.073	1.85
912-101	9.25 to 13	23 to 32	11	27	110,000	201,000	494,000	1/4	6.4	3/8	9.5	0.073	1.85
912-122	9.25 to 13	23 to 32	11	27	110,000	201,000	494,000	1/4	6.4	3/8	9.5	0.073	1.85
912H-108	0.5 to 2.7 psig	0.03 to 0.19 bar	1.5 psig	103	131,000	202,000	470,000	1/4	6.4	3/8	9.5	0.094	2.39

1. Not UL listed.



TYPE P100A



TYPE P100C

### Mounting Brackets

Mounting brackets are used to mount regulators securely to the container or to the side of the building.

Mounting Brackets		
REGULATOR TYPE	BRACKET STYLE	
	Triangular	Bowtie
R622, R632, R642 and R622H	P100A	P100C
R122H, R222 and R232	P100A	----
912	P100A	----



TYPE 50-2



TYPE 50P-5



TYPE 50P-2

### Test Gauge Assemblies

The 50 Series test gauges are used to check appliance line pressure after the regulator has been installed.

Test Gauge Assemblies				
TYPE	INLET CONNECTION	HOSE	PLASTIC	RANGE, IN. W.C. / mbar
50-2	1/4 in. MNPT	No	No	0 to 35 / 0 to 87
50P-2	Female Hose	Yes	Yes	
50P-5		Yes	No	



TYPE P499



TYPE P500

### Adaptor With Screen (Type P499)

Used to convert a 1/4 in. NPT inlet on regulators such as Types 912 and 67C to an inverted flare.

### Type P500 Plug

Keeps dirt and foreign material from entering changeover assemblies. 1/4 in. Inverted Flare.

### Type P501 Filter Assembly

Intended for the inlet of 67C Series regulators, the Type P501 prevents foreign material from reaching the regulator's valve disc.

Adaptor with Screen	
TYPE	SIZE
P499	1/4 in. Inverted Flare x 1/4 in. MNPT



TYPE J542  
BOTTOM CONNECTION



BACK CONNECTION

### Pressure Gauges

Fisher™ offers pressure gauges with bottom or back connection for LPG service. The back connection makes a more compact assembly on installations where space is limited. All gauges have a 2 in. / 51 mm diameter face/black Terluran® plastic case.

Pressure Gauges							
PRESSURE GAUGE RANGE, psig / bar							
Connection	Size, in.	0 to 15 / 0 to 1.0	0 to 30 / 0 to 2.1	0 to 60 / 0 to 4.1	0 to 160 / 0 to 11	0 to 300 / 0 to 20.7	0 to 400 / 0 to 27.6
Bottom	1/4	J500	J501	J502	J504	J506	J542 <sup>(1)</sup>
Back	1/4	J510	J511	J512	J514	J516	N/A

1. For LPG or Anhydrous ammonia (NH<sub>3</sub>) service.

Terluran® is a trademark of BASF.

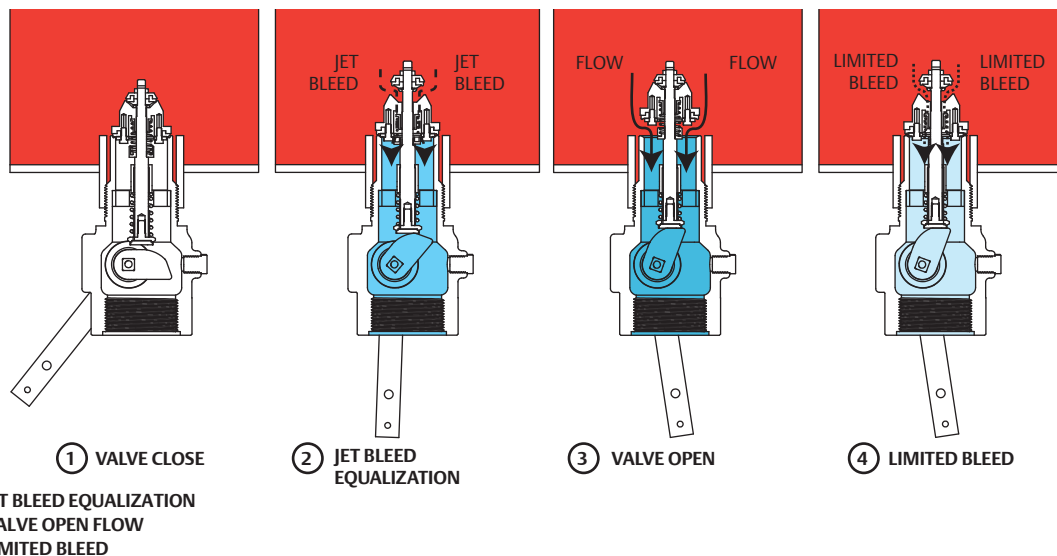

Fisher™ internal valves have gained wide field acceptance for use as primary shutoff valves, excess flow valves and back check valves<sup>(1)</sup>. Internal valves are installed in the inlets and outlets (liquid or vapor) of pressure vessels and in piping systems to control the flow of LPG and Anhydrous Ammonia (NH<sub>3</sub>). The most frequent application is on bobtail and transport truck tanks, but they may also be used on large stationary storage tanks and on in-line installations. The valves can be used in conjunction with or without pumps and compressors.

## Features and Benefits

- **Patented rapid equalization bleed area\***—provides fast valve response for quick opening by moving the flow area away from the stem and allowing it to flow through the poppet. This not only increases flow rate, but also greatly improves valve cycle life which directly improves expected service life.
- **Unique Serviceability Features\***—Removable gland packing, stainless trim parts and poppet designed with integral wrench flat for easy maintenance.
- **Durable Design**—Stainless poppet and stem\* interface smoothly for a long wear life.
- **Excess Flow Closure**—Functions when flow exceeds the valves rated capacity or piping is sheared off at the valve.
- **Back Check Feature**—Allows reverse flow, fill with or without actuator device in valve open position.
- **Spring loaded PTFE stub shaft packing**
- **PTFE wear pads and Rulon® Bushings at critical wear points**
- **Manual, Cable or Air Open/Close Control**
- **Thermal Fusible links or plugs melt at 212 to 220°F / 100 to 104°C and allow valve closure in the event of a fire at the valve.**

## Principle of Operation

The operational schematic below depicts threaded valves, however flanged styles operate in the same manner. For detailed information, refer to the Instruction Manual provided with the valve.

### View #1

The valve is held closed by both tank pressure and the valve's closing spring. There is no leakage past the resilient seats in the poppet to the valve outlet.

### View #2

The valve is opened by moving the operating lever to approximately midpoint in its 70° travel. This allows the cam to place the rapid equalization portion of the valve stem in the pilot opening, permitting a larger amount of product to bleed downstream than if the operating lever were moved to the full open position.

### View #3

When tank and downstream pressure are nearly equal after a few seconds, the excess flow spring pushes open the main poppet and the operating lever can be moved to the full open position.

If tank pressure is greater than the valve's outlet pressure, the main poppet will remain in the closed position. If valve outlet piping is closed off by other valves, however, product bleeding through the pilot will increase until it nearly equals tank pressure and the main poppet opens. The main poppet will not open if valve outlet piping is not closed off so that the outlet pressure can approach tank pressure.

### View #4

Once the main poppet opens, a flow greater than the valve's excess flow spring rating or a sufficient surge in flow forces the main poppet closed against the excess flow spring. The pilot valve allows a small amount of product to bleed, but much less than view # 2 where the rapid equalization portion of the stem is placed in the pilot opening. When the operating lever is moved to the closed position, the valve closes completely and seals tightly (view #1).

\*Unique to the Jet Bleed Internal™ Valve Design only.

1. Because of the integral back check function of these valves, selective filling of manifold storage tanks requires the use of additional shutoff valves.

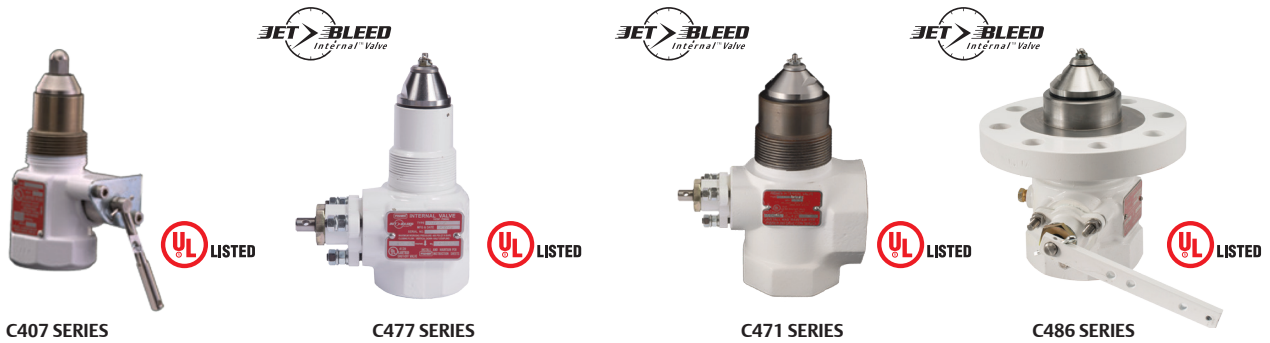

## Threaded Internal Valves

Emerson offers the widest variety of threaded internal valves in the industry. While their most frequent use is in the liquid and vapor openings of bobtail and transport trucks, the valves can also be used in stationary storage tanks, complying with NFPA 58 requirements. Designed as primary shutoff valves, the units are designed with several features that help control product discharge.

All UL-listed internal valves are suitable for LPG or Anhydrous Ammonia (NH<sub>3</sub>) service. Special construction is available for other compressed gases. All threaded internal valves have a compact, one-piece body design. They can be actuated manually, by cable control or with an air cylinder.

**C407-10 Series (1-1/4 in. / DN 32 Body Size)** – An excellent valve for vapor return lines on bobtail trucks. Other applications include use as a main valve on small capacity pumping systems, Anhydrous Ammonia (NH<sub>3</sub>) nurse tanks and in-line installations.

**C477 Series (Straight-Through Body)** – Available in 2 and 3 in. end connections. The most compact and economical unit in the Series, the C477 Series has one bottom outlet. The C477 Series can be used on bobtail, transport, stationary tank and in-line installations.

**C471 Series (Tee Body)** – Available in 2 and 3 in. end connections. This unit is designed with two outlets, bottom and side. The side outlet permits installing horizontal piping immediately adjacent to the tank without the need for extra pipe fittings. Either connection can be used for truck filling or withdrawal. The C471 Series is used primarily on bobtails and transport trucks.

**C486 Series (Flange-by-NPT)** – Available in 3 in. end connections. This unit was designed with an integrally cast inlet flange to quickly bolt to existing installations that historically required a valve to be threaded into a flange. Outlet is standard 3 in. FNPT.

UL® Approved C400 Series Internal Valves

CONNECTION INLET X OUTLET	TYPE		CLOSING FLOW (PROPANE) <sup>(2)</sup>				VAPOR CAPACITY (PROPANE) <sup>(2)</sup>				CLOSING FLOW (NH <sub>3</sub> ) <sup>2</sup>	
	Straight Body	Tee Body	Half Coupling		Full Coupling		25 psig / 1.7 bar Inlet		100 psig / 6.9 bar Inlet		Half Coupling	
			GPM	l/min	GPM	l/min	SCFH	SCMH	SCFH	SCMH	GPM	l/min
1-1/4 in. MNPT x 1-1/4 in. FNPT	C407-10-04	----	40	152	25	95	7400	210	12,700	360	36	136
	C407-10-05	----	50	189	35	133	9600	272	16,400	464	45	170
	C407-10-08 <sup>(1)</sup>	----	80	303	65	246	15,800	447	27,600	781	72	272
2 in. MNPT x 2 in. FNPT	C477-16-10	C471-16-10	105	397	60	227	26,100	739	45,000	1274	95	360
	C477-16-15	C471-16-15	150	568	80	303	39,400	1116	69,000	1954	136	515
	C477-16-25	C471-16-25	250	946	130	492	----	----	----	----	227	859
3 in. MNPT x 3 in. FNPT	C477-24-16	C471-24-16	160	606	120	454	41,100	1164	71,000	2011	145	549
	C477-24-26	C471-24-26	265	1003	230	871	71,800	2033	127,000	3596	239	905
	C477-24-37	C471-24-37	375	1419	320	1211	99,000	2803	178,000	5040	339	1283
	C477-24-46	C471-24-46	460	1741	380	1438	----	----	----	----	415	1571
3 in. CL300 RF x 3 in. FNPT	C486-24-16	----	160	606	120	454	41,100	1164	71,000	2011	145	549
	C486-24-26	----	265	1003	230	871	71,800	2033	127,000	3596	240	908
	C486-24-37	----	375	1419	320	1211	99,000	2803	178,000	5040	340	1287
	C486-24-46	----	460	1741	380	1438	----	----	----	----	418	1582

NOTE: Includes a factory installed Type P340 / P341 latch.

1. LPG Vapor exceeds UL differential requirement of 15 psid / 1.03 bar d.

2. Closing Flows and Vapor Capacities listed are with valve in "bottom of tank" position. See product bulletins for additional data.



### C800 Series Threaded Internal Valves

The Fisher™ C800 Series Internal Valves provide the same primary shutoff and excess flow protection as the C400 Series, but are offered in a wide variety of body materials and elastomeric seals. With industrial process installations spanning the globe, the C800 Series has been the trusted product line for decades.

### Specifications

Emerson is the leader in special service conditions and offers a wide selection of metallic and elastomeric components to meet your demands. Every process or special service fluid has unique compatibility properties, pressure ranges and temperature ranges. Please contact your Fisher LPG Equipment distributor to help select the configuration that's best for you.

C800 Series Special Service Internal Valves									
CONNECTION INLET X OUTLET	BODY STYLE	TYPE	BODY MATERIAL	ELASTOMER AVAILABLE PER ORDER <sup>(3)</sup>					
1-1/4 in. MNPT x 1-1/4 in. FNPT	Straight Body	C807-10	Steel	Fluorocarbon (FKM)	Nitrile (NBR)	PTFE	----	----	----
		C8075-10	SST						
2 in. MNPT x 2 in. FNPT	Tee Body	C871-16	Ductile Iron	EPDM	Viton <sup>®(1)</sup>	Kalrez <sup>®(2)</sup>	Neoprene (CR)	Nitrile (NBR)	PTFE
	Straight Body	C877-16	Ductile Iron						
		C887-16	Steel						
		C897-16	SST						
3 in. MNPT x 3 in. FNPT	Tee Body	C871-24	Ductile Iron						
	Straight Body	C877-24	Ductile Iron						
		C897-24	SST						
3 in. CL300 RF Flange x 3 in. FNPT	Straight Body	C886-24	Steel						

1. Viton<sup>®</sup> or Fluorocarbon (FKM) equivalent  
 2. Kalrez<sup>®</sup> or Perfluoroelastomer (FFKM) equivalent  
 3. Additional materials can be sourced upon request. Please contact your Fisher LPG Equipment Distributor for more information.

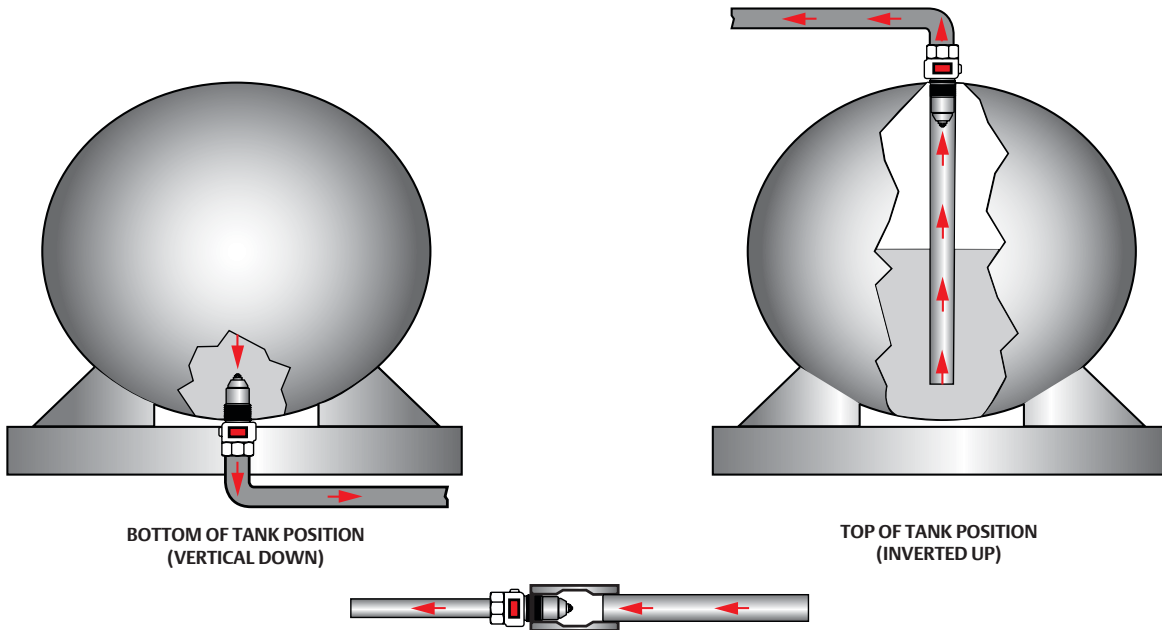

### INTERNAL VALVE TANK POSITIONS

HORIZONTAL POSITION  
(REFER BELOW)

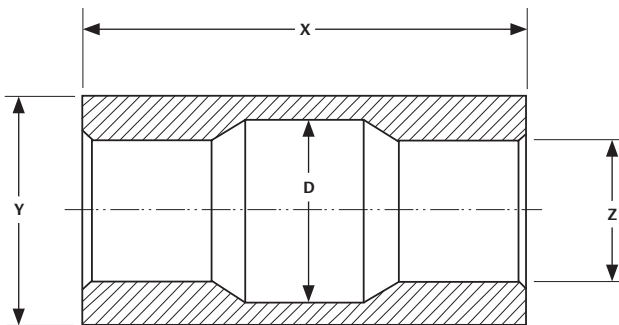

IN-LINE ADAPTOR

#### In-Line Adaptors (for reference only)\*

Z	DIMENSION, IN. / mm		
	X	Y	D
1-1/4 in. FNPT	4.70 / 119	2.75 / 70	2.05 / 52
2 in. FNPT	6.77 / 172	3.5 / 89	2.80 / 71
3 in. FNPT	7.53 / 191	4.5 / 114	3.80 / 97

\* Not for sale.

### Threaded Valve Specifications

- Pressure Rating:** 400 psig / 27.6 bar WOG
- Temperature<sup>(1)</sup>:** C470 Series: -20 to 150°F / -29 to 66°C  
C800 Series: Contact your Fisher™ LPG Distributor for details
- Body:** C470 Series: Ductile Iron  
C407-10 Series: Cast Steel  
C800 Series: Ductile Iron, Steel, SST
- Packing:** PTFE
- Seat Discs:** C407-10 and C470 Series: Molded, synthetic rubber  
C800 Series: Contact your local LPG Distributor for details
- Stub Shaft and Stem:** Stainless steel



### WARNING

A line break downstream of a pump may not actuate the excess flow valve. If any break occurs in the system or if the excess flow valve closes, the system should be shutdown immediately.

**DO NOT USE** the excess flow function incorporated into Fisher C Series internal valves or F Series excess flow valves to satisfy the passive shutdown requirement in 49CFR§173.315(n)(2). **DO NOT** include the excess flow incorporated into Fisher C Series internal valves or F Series excess flow valves in a DCE certification under 49CFR§173.315(n)(2). The cargo tank manufacturer must install some other equipment that satisfies the requirement for passive shutdown capability under 49CFR§173.315(n)(2).

Failure to follow this warning could result in serious personal injury or property damage from fire or explosion in the event of an unintentional release of product during an unload operation.

Type C477/471-24 "Bottom of Tank" Position Flow Curve, Half Coupling

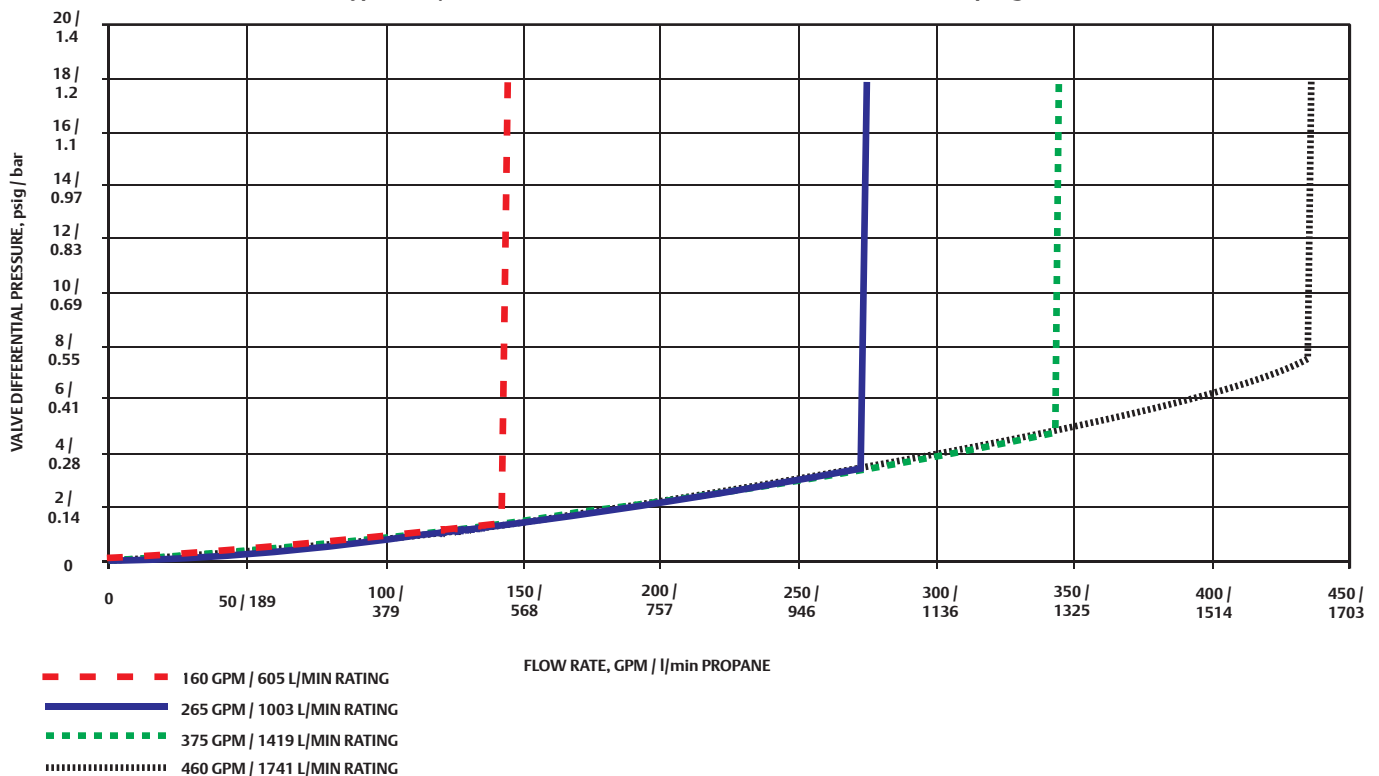

1. Product has passed Fisher testing for pressure shutoff down to -40°F / -40°C.



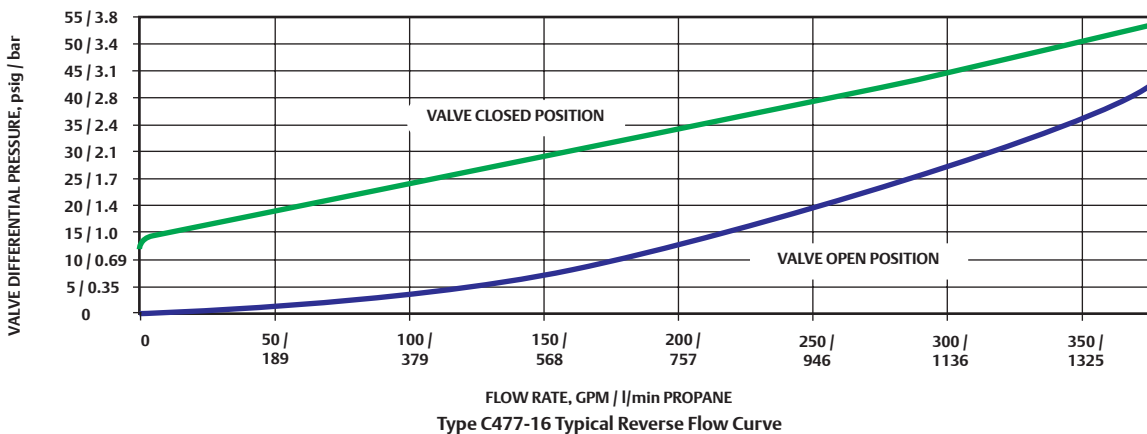
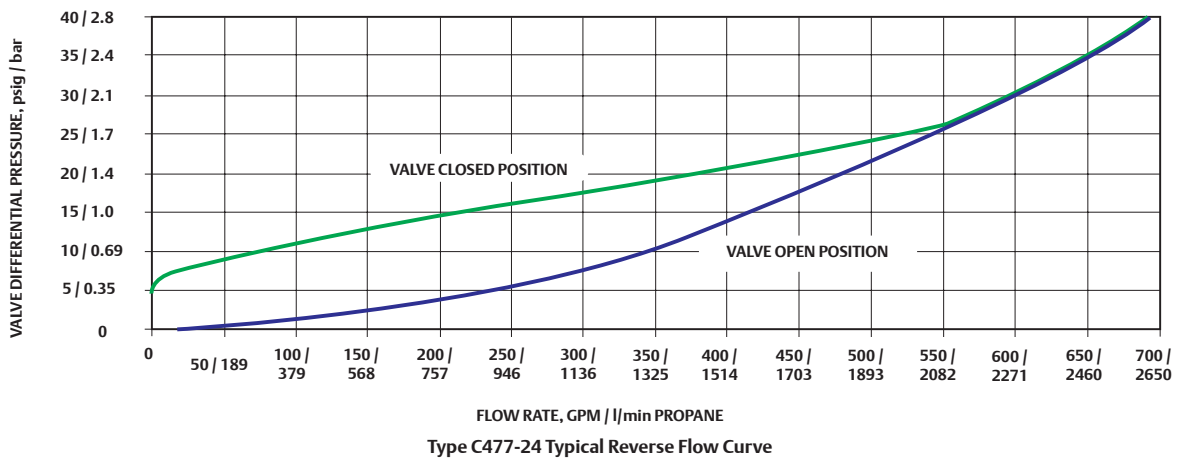
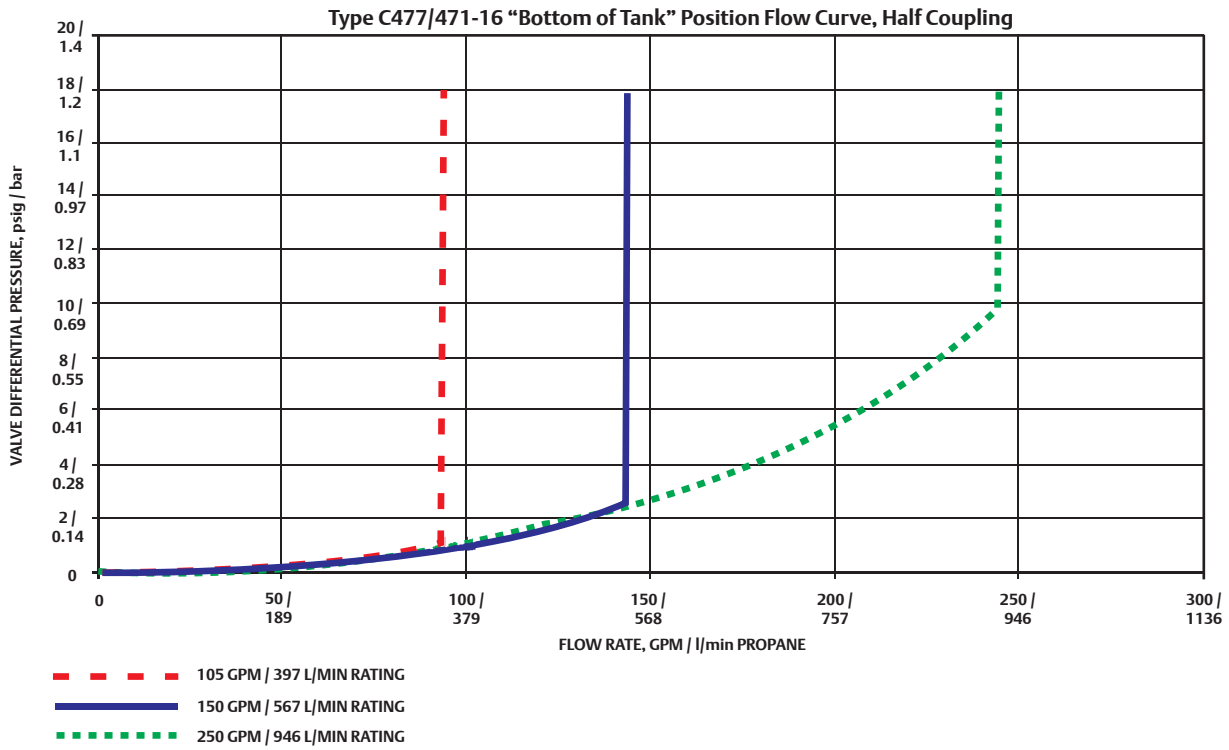

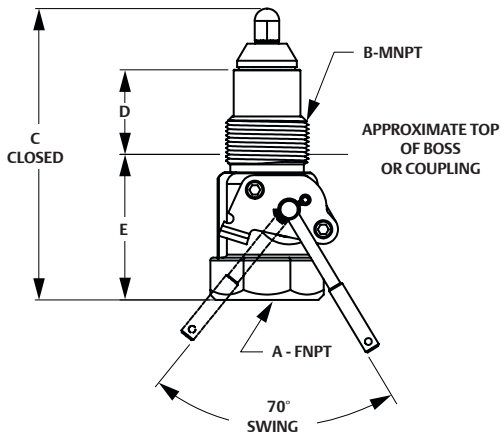

C407-10 AND C807-10 SERIES

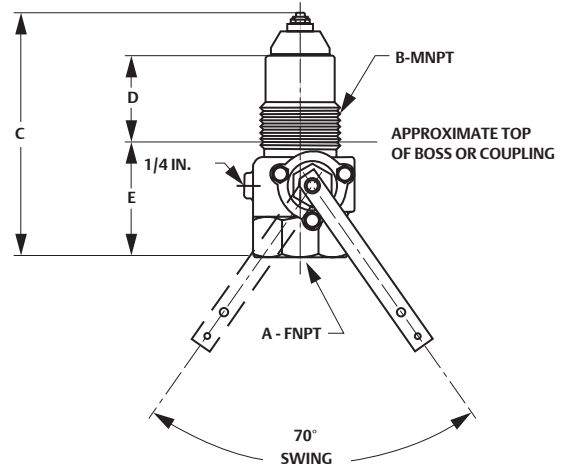

C477, C877 AND C897 SERIES

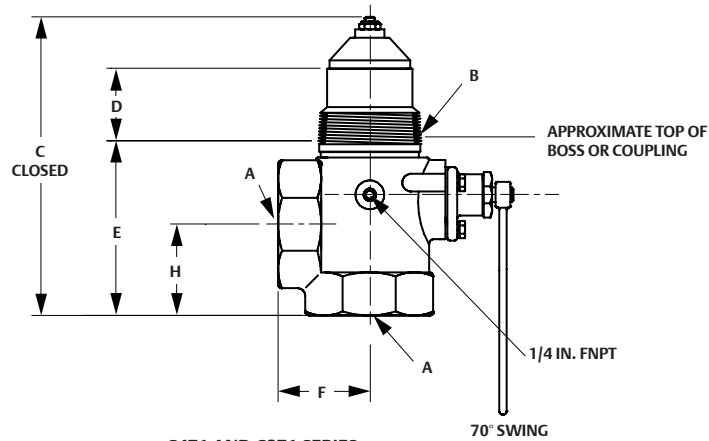

C471 AND C871 SERIES

### UL® Approved C400 Series Internal Valves

TYPE	A, IN. (FNPT)	B, IN. (MNPT)	DIMENSION, IN. / mm					INSTALLATION CLEARANCE DIAMETER, IN. / mm
			C	D	E	F	H	
C407-10	1.25	1.25	5.90 / 150	1.86 / 47	2.88 / 73	----	----	5.00 / 127
C471-16	2	2	8.07 / 205	2.40 / 61	4.05 / 103	2.76 / 70	2.66 / 68	10.00 / 254
C471-24	3	3	9.00 / 229	2.60 / 66	4.57 / 116	3.25 / 83	3.26 / 83	13.38 / 340
C477-16	2	2	8.07 / 205	2.40 / 61	4.05 / 103	----	----	10.00 / 254
C477-24	3	3	9.00 / 229	2.60 / 66	4.57 / 116	----	----	13.38 / 340

### Threaded Body Outlet Design and Size

TYPE	WRENCH SIZE, IN.
C407-10	2-5/16 Octagon
C471-16 and C477-16	3-1/4 Octagon
C471-24, C477-24 and C486-24	4-1/2 Octagon



## Flanged Internal Valves

Flanged valves provide a sturdy and compact means of directly mounting a pump or piping connection. Special stud bolts, weakened with a groove on the outside diameter, are furnished with the valves to permit the pump or piping to shear off in the event of an accident, leaving the valve intact. A built-in excess flow valve reduces the chance of uncontrolled product discharge when flow exceeds the rated flow capacity.

All flanged valves have an internal screen for pump protection that can be easily removed if the valve is used primarily for filling the tank. They also contain PTFE packing to resist stub shaft leakage. These valves can be activated manually, by cable control or by air cylinder (refer to pages 60 and 61).

## 3 in. / DN 80 Flanged Sizes

**Type C484-24** – A single-flange unit widely used on bobtail and transport trucks for a compact means of direct pump connection to the valve outlet. Another application for the Type C484-24 is on in-line installations.

**Type C483-24** – A double-flange unit designed for special bobtail truck applications where the pump must be lowered to clear the truck frame or other obstacles. A special shear section in the body permits the lower section of the valve to shear off in the event of an accident, leaving the critical shutoff parts within the tank.

### UL® Approved 3 In. / DN 80 Flanged Internal Valves

Size	Type Number		Closing Flow Propane								Closing Flow NH <sub>3</sub>			
	Single Flanged	Double Flanged	Single Flanged, Bottom of Tank Position*		Double Flanged, Bottom of Tank Position*		Single Flanged, Top of Tank Position*		Double Flanged, Top of Tank Position*		Single Flanged, Bottom of Tank Position*		Double Flanged, Bottom of Tank Position*	
			GPM	l/min	GPM	l/min	GPM	l/min	GPM	l/min	GPM	l/min	GPM	l/min
3 in. / DN 80	C484-24-16	C483-24-16	160	606	160	606	180	681	180	681	144	545	144	545
	C484-24-25	C483-24-26	250	946	265	1003	250	946	290	1098	239	905	226	855
	C484-24-40	C483-24-40	400	1514	400	1514	400	1514	400	1514	361	1366	361	1366

\* See Internal Valve Flow Positions (page 49) for description of Bottom of Tank, Top of Tank and Horizontal Flow Positions.

### UL Approved 3 In. / DN 80 Flanged Internal Valves

Size	Type		Vapor Capacity Propane							
	Single Flanged	Double Flanged	100 psig / 6.9 bar Inlet, Single Flanged, Bottom of Tank Position**		100 psig / 6.9 bar Inlet, Double Flanged, Bottom of Tank Position**		100 psig / 6.9 bar Inlet, Single Flanged, Top of Tank Position*		100 psig / 6.9 bar Inlet, Double Flanged, Top of Tank Position*	
			SCFH	SCMH	SCFH	SCMH	SCFH	SCMH	SCFH	SCMH
3 in. / DN 80	C484-24-16	C483-24-16	71,000	2011	71,000	2011	96,000	2718	96,000	2718
	C484-24-25	C483-24-26	NOT LISTED		127,000	3568	NOT LISTED		148,000	4191
	C484-24-40	C483-24-40	181,000	5125	181,000	5125	190,000	5380	190,000	5380

\* See Internal Valve Flow Positions (page 49) for description of Bottom of Tank, Top of Tank and Horizontal Flow Positions.

### Flanged Valve Specifications

**Pressure Rating:** 400 psig / 27.6 bar WOG  
**Temperature:** Types C483 and C484<sup>(1)</sup>: -20 to 150°F / -29 to 66°C  
 Type C404-32<sup>(2)</sup>: -20 to 150°F / -29 to 66°C  
**Body:** Types C483 and C484-24: Cast steel and WCC  
 Type C404-32: Stainless steel  
**Packing:** PTFE  
**Seat Discs:** Molded, synthetic rubber  
**Stub Shaft and Stem:** Stainless steel  
**Gaskets:** Non-asbestos spiral wound graphite

**DO NOT USE** the excess flow function incorporated into Fisher™ C Series internal valves or F Series excess flow valves to satisfy the passive shutdown requirement in 49CFR§173.315(n)(2). **DO NOT** include the excess flow incorporated into Fisher C Series internal valves or F Series excess flow valves in a DCE certification under 49CFR§173.315(n)(2). The cargo tank manufacturer must install some other equipment that satisfies the requirement for passive shutdown capability under 49CFR§173.315(n)(2).



### WARNING

A line break downstream of a pump may not actuate the excess flow valve. If any break occurs in the system or if the excess flow valve closes, the system should be shutdown immediately.

Failure to follow this warning could result in serious personal injury or property damage from fire or explosion in the event of an unintentional release of product during an unload operation.

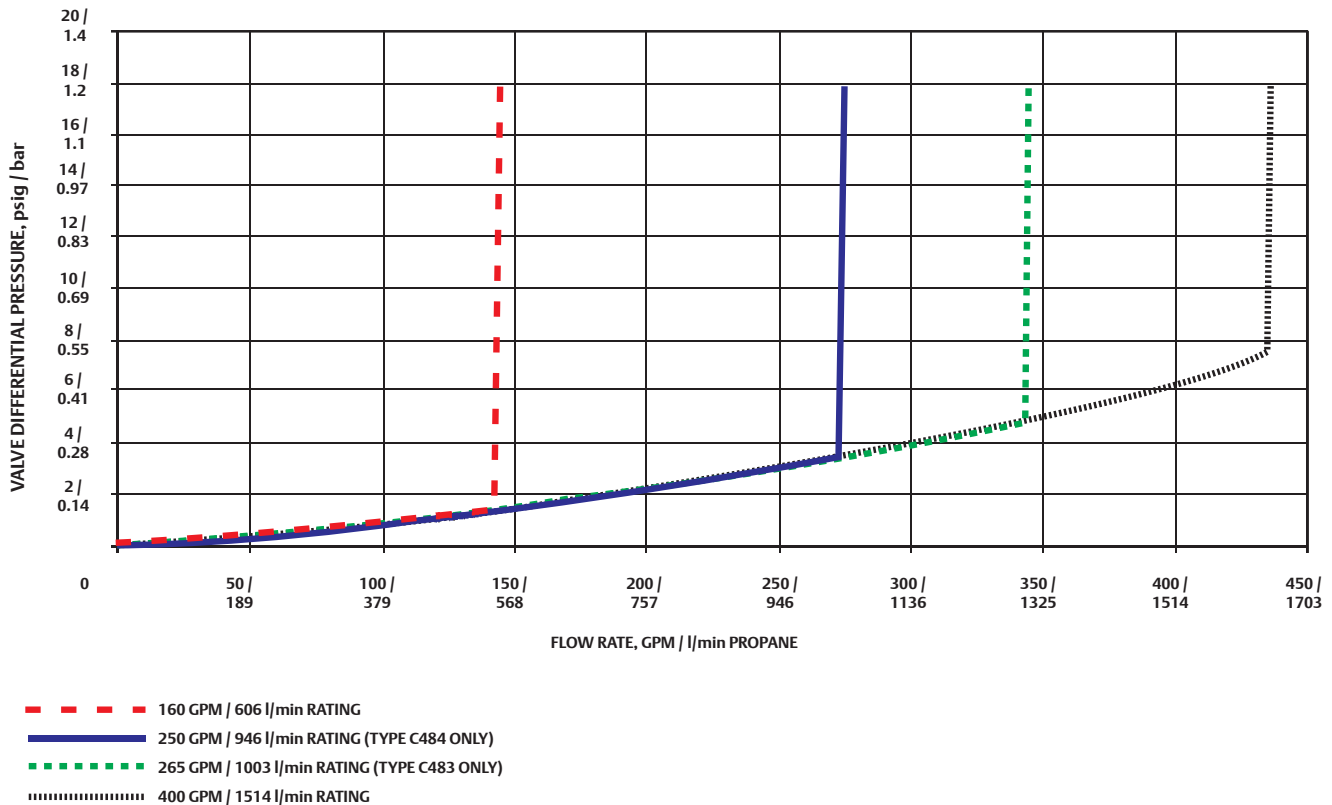

1. Product has passed Fisher testing for pressure shutoff down to -40°F / -40°C.  
 2. Product has passed Fisher testing for pressure shutoff down to -50°F / -45°C.



TYPE C404-32



TYPE C404A32 WITH P614A ACTUATOR

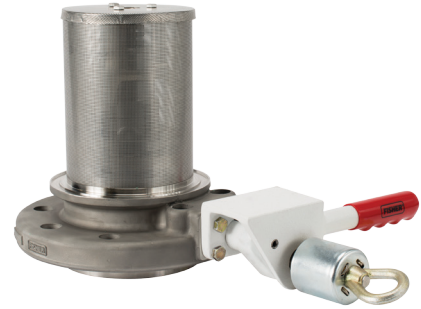

TYPE C404M32 WITH P313 HANDLE ASSEMBLY

### 4 in. / DN 100 Flanged Size (Stainless Steel Construction)

**Type C404-32** – Used widely on transport trucks and large storage tanks, the 4 in. / DN 100 flanged unit comes standard with all stainless steel construction for maximum protection against rust and corrosion. For easy field maintenance, the seat ring is field replaceable.

The Type C404-32 is the only internal valve that cannot be opened and closed by the Type P650 cable control (refer to page 60).

Factory installation of an air cylinder or manual operating handle (with remote release mechanism) is available on the 4 in. / DN 100 flanged valves. Refer to ordering information below.

#### UL® Approved 4 In. / DN 100 Flanged Internal Valves

TYPE <sup>(1)</sup>			INLET, IN. / DN	OUTLET, IN. / DN	CLOSING FLOW, GPM / l/min PROPANE <sup>(2)</sup>	VAPOR CAPACITY, SCFH / SCM <sup>3</sup> PROPANE	
Cable	Air	Manual				25 psig / 1.7 bar Inlet	100 psig / 6.9 bar Inlet
C404-32-34	C404A 32-34	C404M 32-34	4 / 100 CL300 ASME RF Modified 5-7/8 / 149 mm diameter bore	4 / 100 CL300 ASME RF	340 / 1287	61,600 / 1745	104,800 / 2968
C404-32-40	C404A 32-40	C404M 32-40			400 / 1514	63,900 / 1810	108,600 / 3076
C404-32-60	C404A 32-60	C404M 32-60			600 / 2271	83,200 / 2356	141,500 / 4007
C404-32-80	C404A 32-80	C404M 32-80			800 / 3028	259,600 / 7352	356,200 / 10,088
C404-32-100	C404A 32-100	C404M 32-100			1000 / 3785	----	----

1. 4 in. / DN 100 size available in single flange only.  
2. Closing flow vertical down.

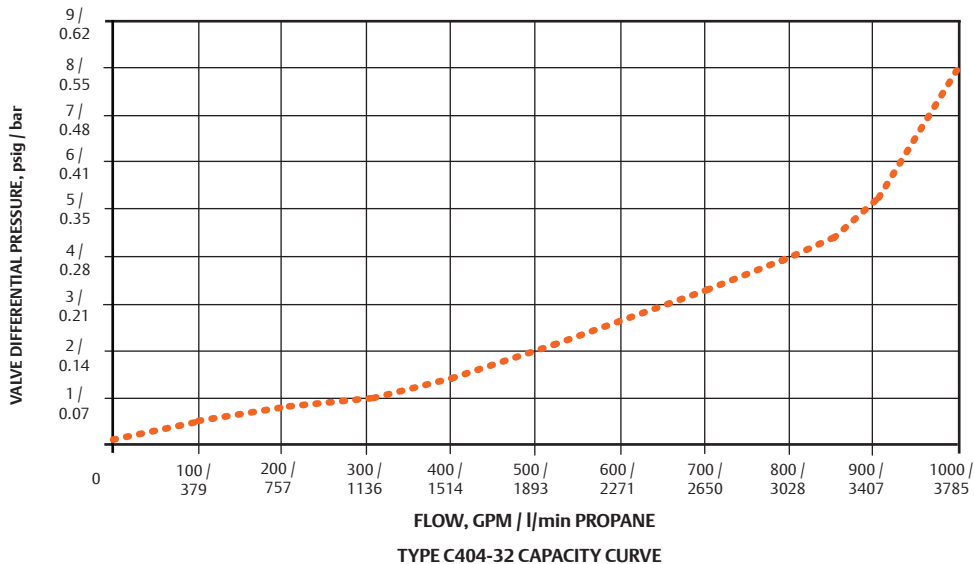

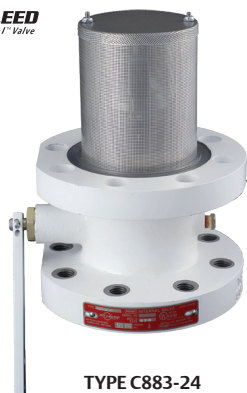

TYPE C883-24



TYPE C884-24

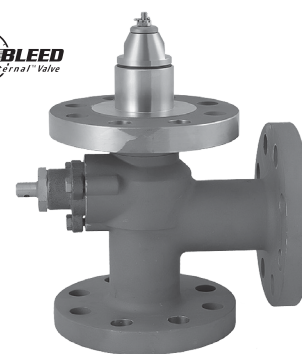

TYPE C891



TYPE C804-32



TYPE C804A-32



TYPE C804M-32

### C800 Series Flanged Internal Valves

The Fisher™ C800 Series Flanged Internal Valves provide the same primary shutoff and excess flow protection as the C400 Series, but are offered in a wide variety of elastomeric seals. With industrial process installations spanning the globe, the robust flanged C800 Series has been the trusted product line for decades.

**Type C804H-32 for Y-Grade:** designed with a new formulated seal to withstand corrosive effects in Y-Grade natural gas liquid (NGL) applications. Retrofit kit available for Type C404-32: RC404YGT012.

### Specifications

Emerson is the leader in special service conditions and offers a wide selection of metallic and elastomeric components to meet your demands. Every process or special service fluid has unique compatibility properties, pressure ranges and temperature ranges. Please contact your Fisher LPG Equipment distributor to help select the configuration that's best for you.

**C800 Series Special Service Internal Valves**

CONNECTION INLET X OUTLET	BODY STYLE	TYPE	BODY MATERIAL	ELASTOMERS AVAILABLE FOR ORDER <sup>(3)</sup>											
				EPDM	Viton <sup>®(1)</sup>	Kalrez <sup>®(2)</sup>	Neoprene (CR)	Nitrile (NBR)	PTFE						
2 in. CL300 RF	Tee Body	C891-16	SST	EPDM	Viton <sup>®(1)</sup>	Kalrez <sup>®(2)</sup>	Neoprene (CR)	Nitrile (NBR)	PTFE						
3 in. CL300 RF	Tee Body	C891-24													
3 in. Mod. CL300 RF Flange x 3 in. CL300 RF Flange	Double Flange	C883-24	Steel												
	Single Flange	C884-24													
4 in. Mod. CL300 RF Flange x 4 in. CL300 RF Flange	Single Flange	C804-32	SST							Viton <sup>®(1)</sup>	PTFE	Y-Grade NGL <sup>(6)</sup>	Nitrile (NBR)	----	----
		C804A-32 <sup>(4)</sup>													
		C804M-32 <sup>(5)</sup>													

1. Viton® or Fluorocarbon (FKM) equivalent  
 2. Kalrez® or Perfluoroelastomer (FFKM) equivalent  
 3. Additional materials can be sourced upon request. Please contact your Fisher LPG Equipment Distributor for more information.  
 4. Air Actuation.  
 5. Manual.  
 6. Available as Types C804H32, C804HA32 and C804HM32.

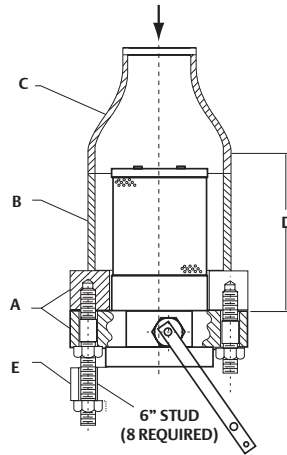

<b>In-Line Piping</b>				
A	DIMENSION, IN. / mm			OUTLET
	B	C	D	E
ASME CL300 RF Flange	Pipe Size	Reducer	Minimum	ASME CL300 RF Flange
3 in. / DN 80	6 / 152	6 x 3 / 152 x 76	7.9 / 201	3 in. / DN 80
4 in. / DN 100	8 / 203	8 x 4 / 203 x 102	11.5 / 292	4 in. / DN 100

### Studding Outlet (modified flange)

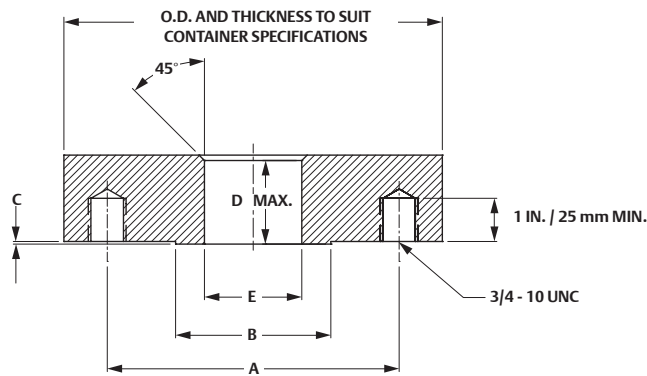

<b>Tank Connections</b>								
MODIFIED CL300 ASME RF FLANGE	DIMENSION, IN. / mm							MATING FLANGE O.D., IN. / mm
	A			B RF	C RF	D	E (Modified) <sup>(1)</sup>	
	DBC	No.	Size					
3 in. / DN 80	6.62	8	0.75	5.75 / 146	0.06 / 1.5	1.50 / 38	4.62 / 117	8.25 / 210
4 in. / DN 100	7.88	8	0.75	7.00 / 178	0.06 / 1.5	1.56 / 40	5.88 / 149	10.00 / 254

1. Can be increased up to 4.81 in. / 122 mm for 3 in. valve and 6.19 in. / 157 mm for 4 in. valve, if valve and gasket are centered with modified flange opening.

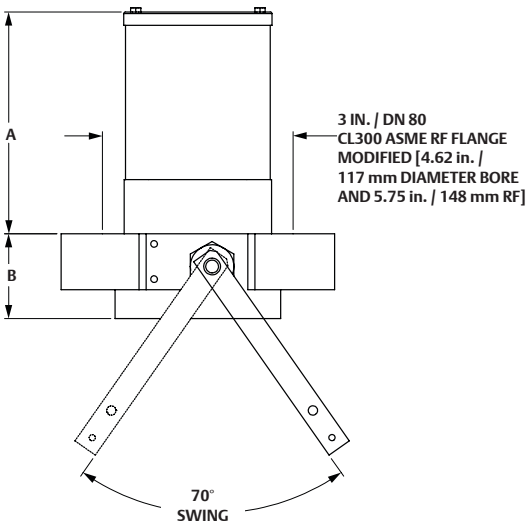

TYPES C484-24 AND C884-24

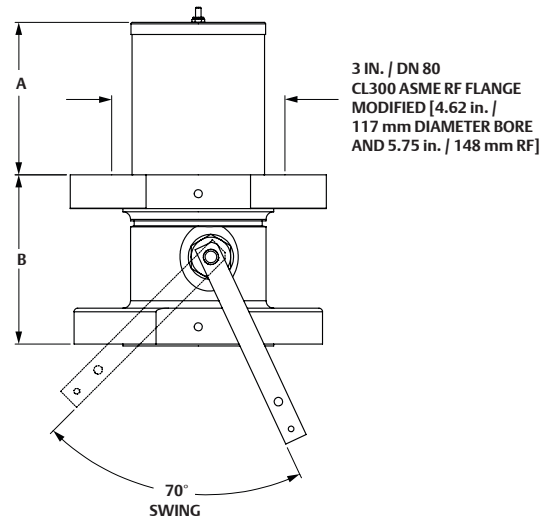

TYPES C483-24 AND C883-24

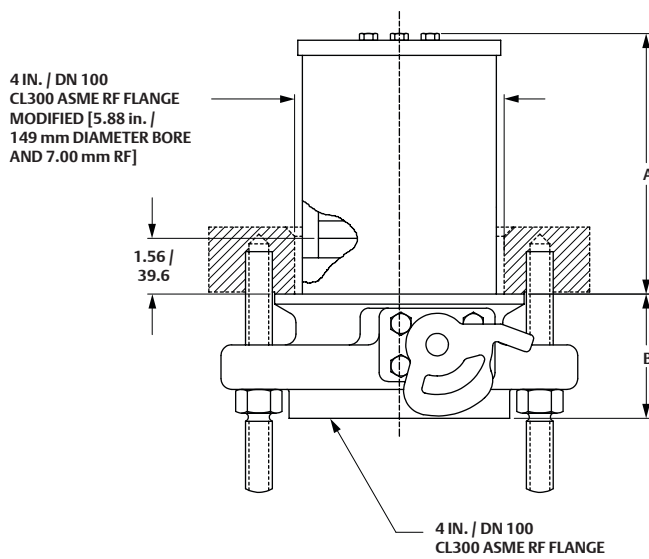

TYPES C404-32 AND C804-32

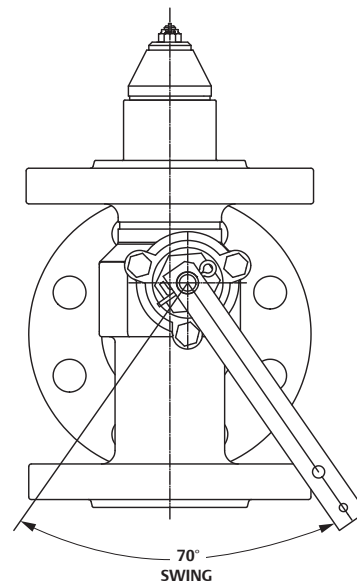

TYPE C891

### Flanged Valves

TYPE	TANK CONNECTION, IN. / DN	DIMENSION, IN. / mm	
		A	B
C484-24	3 / 80 CL300 RF Flange	6.75 / 171	2.56 / 65
C483-24	3 / 80 CL300 RF Flange	5.33 / 135	5.62 / 143
C404-32	4 / 100 CL300 RF Flange	7.55 / 192	3.48 / 88



## Air Interlock Systems

An air interlock system can be configured for transport and bobtail trucks with air brakes by using air cylinder actuated internal valves. This system simultaneously interlocks the internal operation with the truck air brakes without affecting normal air brake operation. It complies with DOT MC331 and NFPA 58 requirements regarding thermal and remote release feasibility.

The air interlock system permits the air brakes to set before the internal valve opens – even if the truck operator forgets to set the brakes. The brakes cannot be released until the internal valve is closed.

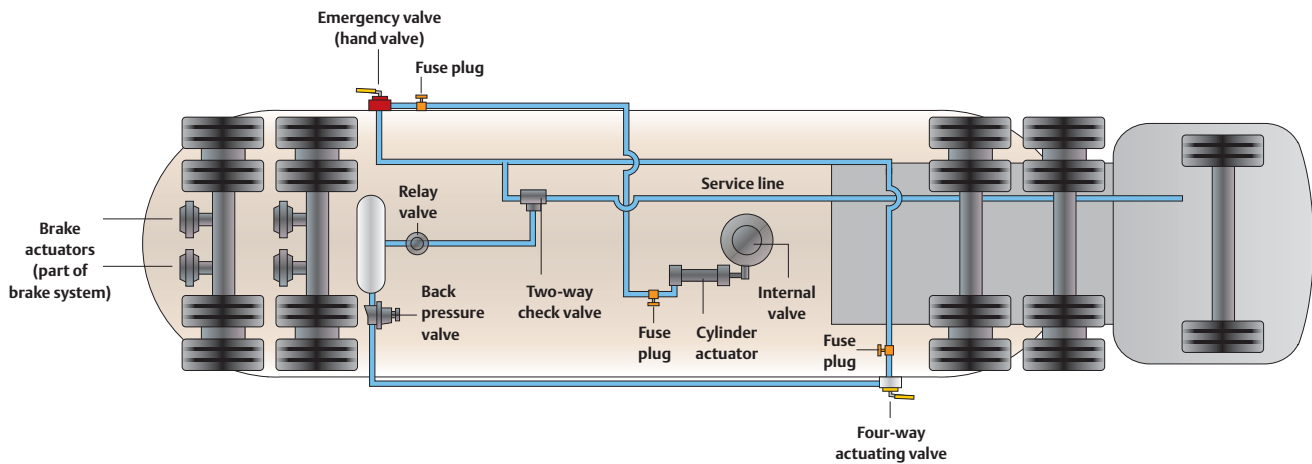

AIR INTERLOCK HOOK-UP ON TRANSPORT TRUCK

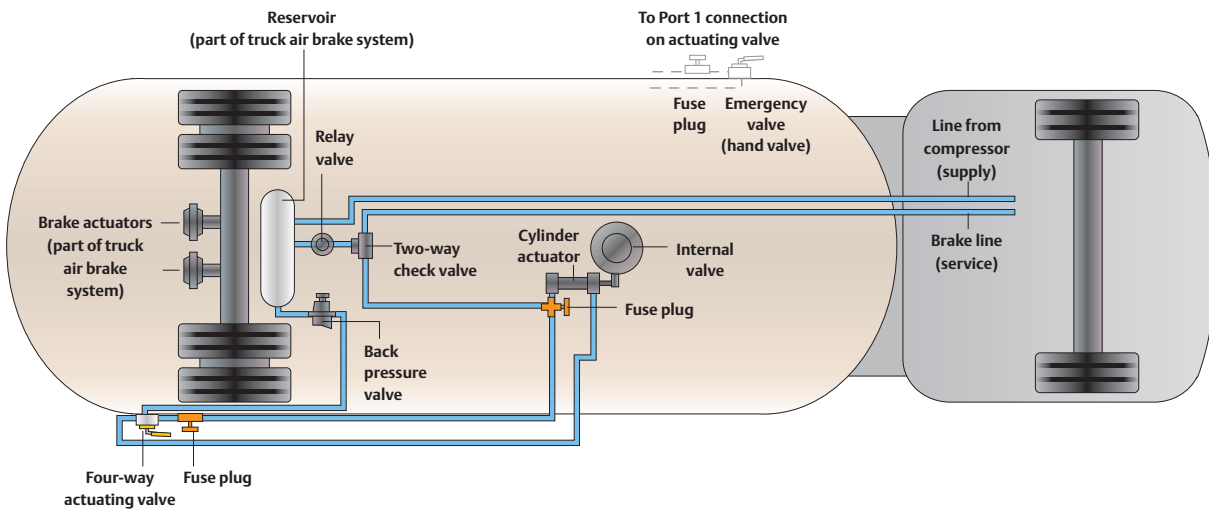

AIR INTERLOCK HOOK-UP ON BOBTAIL TRUCK

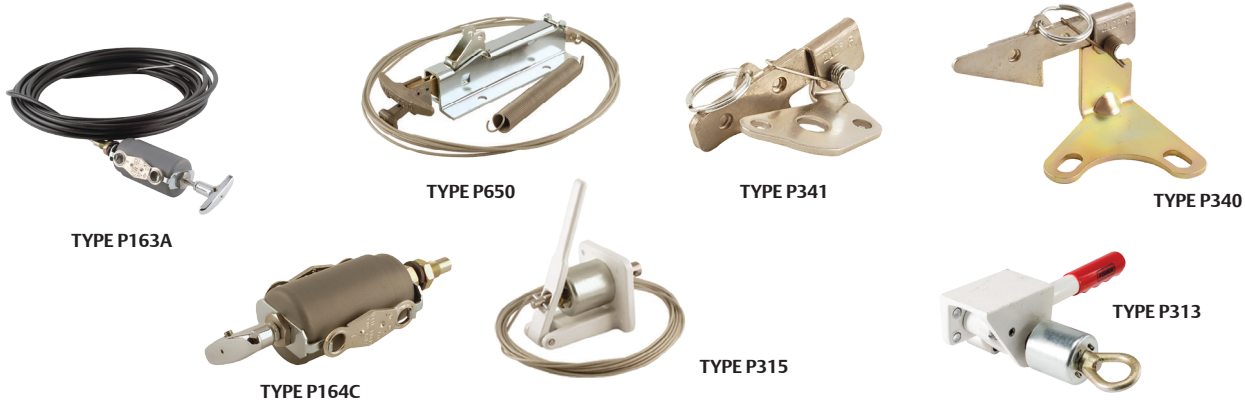

### Cable Controls

Fisher™ cable controls and accessories can be furnished to remotely open and close all internal valves except the 4 in. / DN 100 flanged size. This equipment can be used to comply with NFPA 58 and DOT requirements for MC331 cargo tanks.

Cable systems can also be used on stationary storage tanks at bulk plants and on in-line applications to increase safety during transfer operations. All fusible elements and links used in the cable control systems comply with NFPA 58 and MC331 requirements.

**Type P650 or P651 Primary Cable Control** – Capable of actuating all Fisher internal valves except the 4 in. / DN 100 Type C404-32, the Type P650 or P651 opens and closes the valve from a remote point, usually the rear of the bobtail or transport. Pulling the handle of the primary control opens the internal valve; pushing the handle closes the valve. There are three notches on the primary control that give a travel of 4, 5 or 6 in. / 102, 127 or 152 mm depending upon the travel required by the valve’s operating lever.

Included with each Type P650 primary control is a 20-foot / 6.1 m cable, Type P134 fusible links, a return spring and mounting hardware. If just the primary cable control is needed, order Type P651, which is available without any of the other accessories.

**Type P163A or P164A Auxiliary Remote Release** – These units allow the internal valve to be closed from a location other than the primary control point (Type P650 or P651). Pulling the auxiliary release handle trips the release mechanism on the primary control to close the internal valve.

The two assemblies are identical except for the length. Type P163A has an untrimmed length of 25 feet / 7.6 m and Type P164A has an untrimmed length of 50 feet / 15.2 m. Both cables can be trimmed to any length. Both releases can be installed through mounting brackets up to 3/8 in. / 9.5 mm thick.

Type P164B – a release assembly that uses 50 feet / 15 m of cable housing which does not require elaborate guiding like uncovered cables.

Type P164C – an Auxiliary Remote Release without cable is also available.

### Latch/Remote Release Mechanisms

With the exception of the 3 in. / DN 80 flanged sizes, all Fisher internal valves can be fitted with a manual latch/remote release mechanism. When the internal valve’s operating lever is manually moved to the open position, the lever can be latched in the open position. The lever can be released from a remote location by pulling on the cable attached to a pull ring, thus closing the internal valve. A built-in fusible element in the latch/release melts if exposed to fire allowing the operating lever to return to the closed position.

**Type P340** – Fits all 2 and 3 in. NPT internal valves (Types C471 and C477). Type P340 is easily installed in the field by removing two of the three gland cap screws.

**Type P341** – Fits 1-1/4 in. NPT C407 Series internal valves. Also available factory installed, Type C407M10.

**Type P342** – Bi-directional latch/remote release for the 1-1/4 in. NPT C407-10 Series allows operation from two directions.

**Type P313** – Fits 4 in. / DN 100 Type C404-32 internal valves. Also available factory installed, Type C404M32. The Type P315 remote release should be used with this release.

**Type P314** – This cable assembly is used as an attachment from the Type C404-32 operating lever to the primary cable control. The assembly includes a 40-foot / 12.2 m cable, a special bushing with a fusible element and clamp. The bushing fits in the valve-operating lever and has a built-in fusible element that will melt if exposed to fire, allowing the Type C404-32 to close. The cable connects to the bushing and the clamp permits the other end of the cable to be attached to the fusible link (not furnished) at the primary cable control.

**Type P315** – On manually actuated 4 in. / DN 100 valves (Type C404M32), Type P315 remote handle release can be used to close the internal valve from a remote location. Cable linkage (30 feet / 9.1 m) and mounting hardware are included.

### Internal Valve Accessories

INTERNAL VALVE SIZE, IN. / DN	PRIMARY CABLE CONTROL	AUXILIARY REMOTE RELEASE	CABLE ASSEMBLY	LATCH/RELEASE MECHANISM
1-1/4, 2 and 3 / 32, 50 and 80 (NPT or Flanged)	Type P650 or P651 <sup>(1)</sup>	Type P163A or P164A	Included with Type P650	Type P341, P342 (C407-10 Series) or Type P340 (C400 Series)
4 / 100 Flanged	Use Allegheny or Wheaton Control	Type P315	Type P314	Type P313 <sup>(2)</sup>

1. Type P651 is a primary control only, no accessories.

2. Use with Type P315 remote release mechanism.

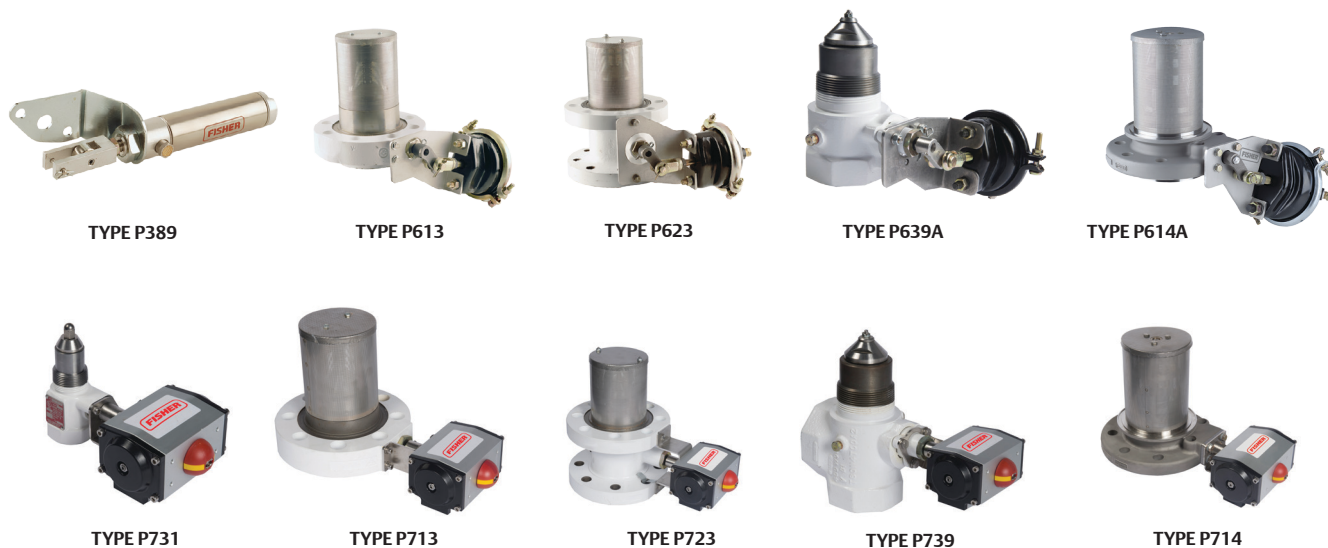

NOTE: INTERNAL VALVES SHOWN ARE NOT INCLUDED.

## P Series Pneumatic Actuators

All Fisher™ internal valves can be ordered with a pneumatic actuators that permits the valve to be opened and closed from a remote location. Two styles of pneumatic actuators are available: P600 Series ‘Brake Chamber’ style actuators and P700 Series ‘Rotary’ style rack-and-pinion actuators. For the P600 Series when air pressure is applied to the actuator, it moves the actuator’s rod and internal valve operating lever to the open position. Upon loss of air pressure, the valve’s operating lever returns to the closed position. For the P700 Series, when air pressure is applied to the actuator, pistons act on a gear assembly that rotates the internal valve lever to the open position. Upon loss of air pressure, the valve will return to the closed position. Besides air pressure, nitrogen or carbon dioxide can also be used to pressure the actuators. In addition, the P700 Series supply source can be propane vapor.

Use of a pneumatic actuator permits the opening and closing of the internal valve to be tied into the air brake of the transport or bobtail. Pneumatic Actuators can also provide a convenient way to remotely operate a number of internal valves on stationary storage tanks at bulk plants.

**Type P389 (1-1/4 in. / DN 32 Size)** – This actuator can only be used with the C407-10 Series valve. All necessary hardware for installing the actuator is included. Minimum pressure is 60 psig / 4.1 bar; maximum

pressure is 250 psig / 17.2 bar. Fuse Plug Part Number T1140399982 ordered separately.<sup>(1)</sup>

**Types P613, P623, P639A and P614A Brake Chamber Actuators** – The actuator attaches directly to the valve after removal of the cable-operating lever. Included in each assembly is an operating lever and appropriate mounting hardware specific to each respective valve.

These actuators can only be used with the internal valves as specified on the table below.

**Types P731, P713, P714, P723 and P739 Rotary Actuators** – The actuator attaches directly to the valve after removal of the cable-operating lever. Included in each assembly is an operating lever and appropriate mounting hardware specific to each respective valve in addition to air pressure, nitrogen and carbon dioxide, the P700 Series can be actuated with propane vapor.

**Fuse Plugs** – When installed in the actuator piping at the valve, will allow the pneumatic pressure to vent closing the valve if the plug is exposed to temperature between 208 to 220°F / 98 to 104°C. Fuse plugs are available in two sizes, 1/8 in. NPT (T1140399982) and 1/4 in. NPT (T1033699982). Fuse Plugs come with all Types P600 and P700 actuators, EXCEPT Type P389. Part Number T1140399982 to be ordered separately.<sup>(1)</sup>

Pneumatic Actuators Ordering Information				
INTERNAL VALVE TYPE	BRAKE CHAMBER STYLE PNEUMATIC ACTUATOR		ROTARY STYLE PNEUMATIC ACTUATOR	
	Type	Supply Pressure Range, psig / bar	Type	Supply Pressure Range, psig / bar
C407-10	P389 <sup>(1)</sup>	60 to 250 / 4.1 to 17.2	P731	50 to 125 / 3.5 to 8.6
C484-24	P613	20 to 125 / 1.4 to 8.6	P713	25 to 125 / 1.7 to 8.6
C483-24	P623	20 to 125 / 1.4 to 8.6	P723	25 to 125 / 1.7 to 8.6
C471 and C477 (2 and 3 in. NPT Sizes)	P639A	20 to 125 / 1.4 to 8.6	P739	25 to 125 / 1.7 to 8.6
C404-32	P614A	40 to 125 / 2.8 to 8.6	P714	40 to 125 / 2.8 to 8.6

1. Fuse Plug Part Number T1140399982 must be ordered separately.

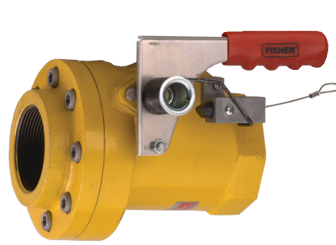

TYPE N551 (VALVE CLOSED)

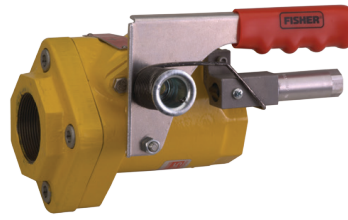

TYPE N551 WITH TYPE P327D



TYPE N551 WITH TYPE P539A

## Snappy Joe™ Emergency Shutoff Valves for Bulk Plants

Snappy Joe **Type N551** Emergency Shutoff Valves (ESVs) are designed for in-line installations, usually near a bulkhead. The valves provide a means of shutting off gas in the event of a hose rupture or piping break at the transfer area to avoid a large scale loss of LPG or Anhydrous Ammonia (NH<sub>3</sub>).

The valves can be manually opened and closed at the installed location or closed remotely by either cable or air. A remote operating actuator is also available.

**High Flow Capacity** – The main poppet moves completely out of the flow stream for extremely low restriction-to-flow.

**Operational Ease** – Moving the operating lever to the vertical position opens the valve, making it simple to tell if the unit is open or closed. A pilot valve in the poppet opens as the lever is moved upward to pressurize the hose. Once equalized, the poppet moves quickly to the open position.

The valve is closed by simply pushing the lever down without first having to trip a latch. The operating lever is easily reached from across a bulkhead. All sizes look similar and operate exactly the same, an important point in an emergency situation.

**Fusible Element** – The fusible element is located at the hub of the operating lever and stub shaft. When exposed to fire, the element melts allowing the stub shaft to turn. The poppet then moves to the closed position, even if the operating lever has been wired open.

**Rugged Construction** – Heavy duty construction makes Snappy Joe ESVs suitable for use as a “working” shutoff valve for the transfer area, even under frequent use. The internal closing spring is protected from the elements and tampering. All seats and seals use UL®-approved materials rated for -40°F / -40°C and have metal back-up seals for extended fire resistance. The valves are rated 400 psig / 27.6 bar WOG.

**Ease of Service** – Serviceable without removal from the pipeline. Parts that wear are external and can be changed out in a matter of minutes. The packing can be changed with the valve in-line.

**Cable Release** – Standard valves are fitted with a release mechanism for cable attachment. A cable connected to the wire loop allows closure from a safe remote location, such as the bulk plant entrance.

While the ordinary cable can be used, the **Type P164B** release assembly is available. This assembly uses 50 feet / 15 m of cable housing which does not require elaborate guiding like uncovered cables.

**Pneumatic Operation** – Remote pneumatic closure is available with **Type P327D** release. Depending upon valve inlet pressure, a minimum supply pressure of 30 to 70 psig / 2.1 to 4.8 bar on the Type P327D allows the valve to be latched in the open position with manual closure possible at the valve. Loss of supply pressure to the cylinder permits the ESV to close. Air, nitrogen or CO<sub>2</sub> can be used for the cylinder supply source. Maximum inlet pressure to the cylinder is 125 psig / 8.6 bar. Operating Temperature Rating = -40 to 160°F / -40 to 71°C.

**Type P539A** pneumatic actuator permits opening and closing Fisher™ N551 Series Snappy Joe emergency shutoff valves (ESVs) both at the valve with the use of a pneumatic 4-way valve and from a remote location. The actuator opens the valve when pressure is applied. Minimum pressure is 20 psig / 1.4 bar and maximum pressure is 30 psig / 2.1 bar.

Upon loss of pressure, the N551 Series closes, assisted by the spring in the pneumatic actuator.

### Type N851 for Special Service

The Type N551 can be ordered with alternate elastomer compounds for various industrial process applications. The **Type N851K** is assembled with FFKM (Kalrez® or equivalent) and can be used in a variety of fluid services. Other materials may be available. Contact your local Fisher LPG Distributor for more details.

Emergency Shutoff Valves				
TYPE	BODY SIZE, IN.	FLOW IN GPM / l/min PROPANE		ACCESSORIES
		1 psid / 69 mbar d	2 psid / 0.14 bar d	
N551-10	1-1/4 FNPT	110 / 416	150 / 568	Type P164B Cable Release Type P327D Pneumatic Release Type P539A Pneumatic Actuator
N551-16	2 FNPT	190 / 719	295 / 1117	
N551-24	3 FNPT	580 / 2195	850 / 3127	

TYPE N551 CAPACITY CURVE

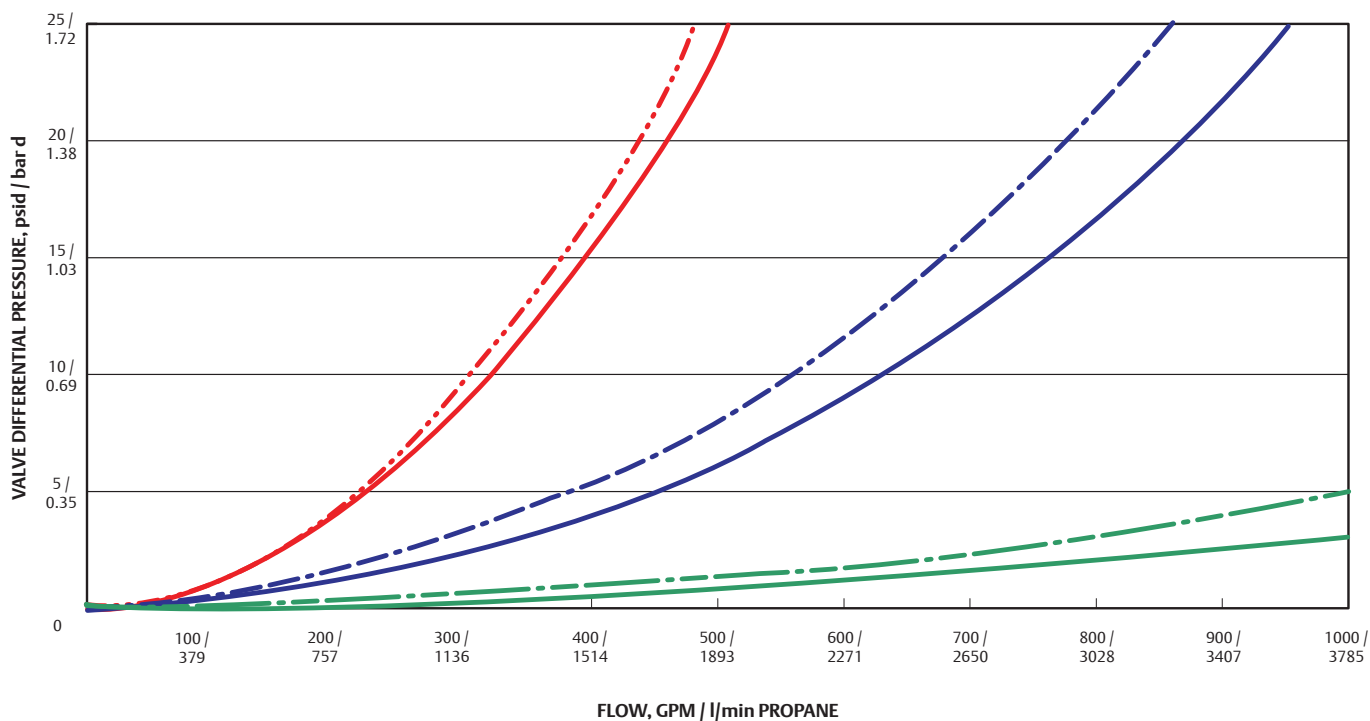

- TYPE N551-10 WITH TYPE P539A ACTUATOR
- TYPE N551-10 WITH MANUAL LEVER
- TYPE N551-16 WITH TYPE P539A ACTUATOR
- TYPE N551-16 WITH MANUAL LEVER
- TYPE N551-24 WITH TYPE P539A ACTUATOR
- TYPE N551-24 WITH MANUAL LEVER

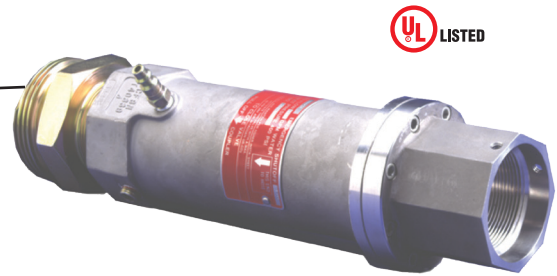
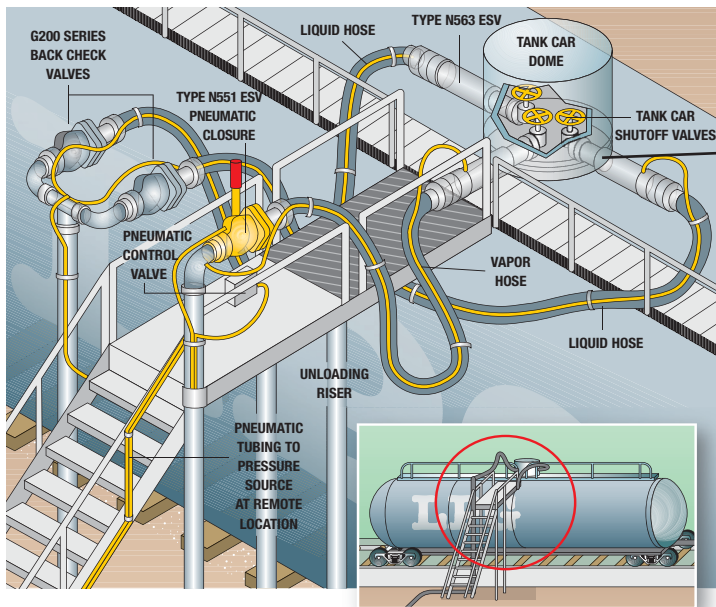

TYPE N562/N563

## Snappy Joe™ Emergency Shutoff Valves for Railroad Tank Cars

Snappy Joe Emergency Shutoff Valves (ESVs) are designed for railcar protection and attached to the shutoff valves on railroad tank cars (refer to installation drawing). Typically three ESVs are used – two on the liquid lines and one on the vapor line. NFPA 58 regulations call for ESV protection on both sides of the transfer hose or piping. Types N562 and N563 are UL® listed for service in Propane and Anhydrous Ammonia. Its Nitrile (NBR) elastomer are UL approved to -40°F / -40°C.

Pneumatically operated, the valve is opened and closed by means of a standard quick-disconnect coupling (furnished). Approximately 20 to 60 psig / 1.4 to 4.1 bar is needed to open the valve, depending upon tank car pressure. Remote closure from one or more points, such as the unloading riser, is accomplished by exhausting pressure from the valve's piston chamber with a pneumatic control valve.

### Ease of Use

- Nipple lengths attached to the 2 in. NPT female inlet are field selectable. These nipples can be easily secured and replaced.
- Outlet is FNPT or ACME for easy connection
- Pneumatically operated with quick disconnect coupling (included)

### Application Flexibility

- UL approved for LPG and Anhydrous Ammonia (Nitrile (NBR) only)
- Comprehensive line of elastomers for all other compressed gas service
- A 1/4 in. FNPT opening in the hex portion can be used to install a bleed valve

### System Protection

- Remote shutoff capability
- Emergency shut-off in the event of fire: valve closes at 212°F / 100°C

### Durability

- All Stainless steel construction
- Wrenching Hex to prevent damage when connecting or disconnecting
- Hardened Stainless steel threads to reduce wear

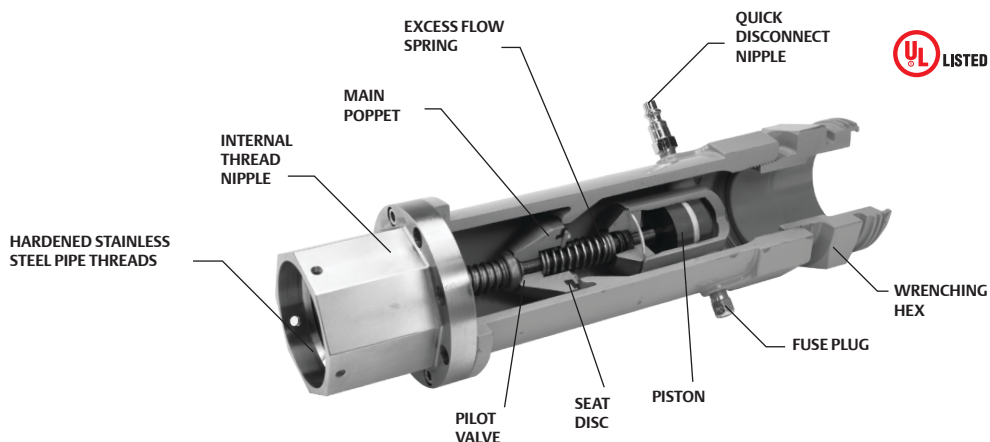

TYPE N562

**Type N562** ESV integrates shutoff valve with an excess flow protection to automatically close if flow exceeds 200 GPM / 757 l/min propane at 13 psid / 0.90 bar d.

Railcar Emergency Shutoff Valves with Excess Flow				
TYPE	ELASTOMER	UL® LISTED	INLET CONNECTION, IN.	OUTLET CONNECTION, IN.
N562-16	Nitrile (NBR)	YES	2 FNPT	2 FNPT
N562-18				2-1/4 Male Acme
N562-26				3-1/4 Male Acme
N862K-16	Kalrez®(1)	NO		2 FNPT
N862K-18				2-1/4 Male Acme
N862K-26				3-1/4 Male Acme
N862V-16	Viton®(3)	NO		2 FNPT
N862V-18				2-1/4 Male Acme
N862V-26				3-1/4 Male Acme

**Type N563** ESV is designed for higher flow needs. It flows up to 413 GPM / 1563 l/m to reduce loading/unloading time and provide faster railcar turnover.

Railcar High Flow Emergency Shutoff Valves				
TYPE	ELASTOMER	UL LISTED	INLET CONNECTION, IN.	OUTLET CONNECTION, IN.
N563-16	Nitrile (NBR)	Yes	2 FNPT	2 FNPT
N563-26				3-1/4 Male Acme
N863E-16	EPDM			2 FNPT
N863E-26				3-1/4 Male Acme
N863K-16	Kalrez®(1)			2 FNPT
N863K-26				3-1/4 Male Acme
N863N-16	Neoprene (CR)	No		2 FNPT
N863N-26				3-1/4 Male Acme
N863T-16	Teflon®(2)			2 FNPT
N863T-26				3-1/4 Male Acme
N863V-16	Viton®(3)		2 FNPT	
N863V-26			3-1/4 Male Acme	

1. Perfluoroelastomer (FFKM) equivalent  
 2. PTFE equivalent  
 3. Fluorocarbon (FKM) equivalent

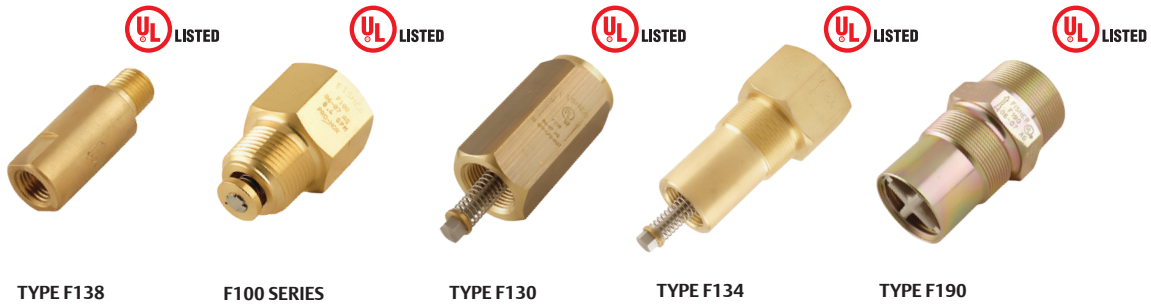

Excess flow check valves are intended to close upon excessive discharge of vapor or liquid resulting from a break in the hose or piping system. They are used to protect cylinder, tank and piping systems and are available in a large variety of sizes and body configurations. Standard temperature rating is -20 to 160°F / -29 to 71°C.

When flow exceeds the valve's setting, the valve closes and remains closed until the system equalizes. A built-in equalizing passage automatically opens the valve once pressure on both sides of the poppet is equal. Valves larger than 1/2 in. NPT have a drill size No. 60. Valves with a 1/2 in. NPT and smaller have a limited bypass to comply with NFPA 58.



### WARNING

A break or leak downstream of an excess flow valve, that does not allow a flow equal to the valve flow rating, will not actuate the valve and could cause a hazardous condition. For this reason, system operators should be familiar with the shutoff valves in the system so that necessary precautions can be taken in an emergency.

Care must be taken to be sure the valve's closing rate is less than the capacity of the LPG or Anhydrous Ammonia (NH<sub>3</sub>) system in which the valve is installed. Brass valves are not suitable for Anhydrous Ammonia (NH<sub>3</sub>) applications.

See the WARNING on page 50, if these excess flow valves are to be used on DOT Cargo Tanks.

### UL® Approved Excess Flow Check Valves

TYPE	MATERIAL	APPLICATION	INLET CONNECTION, IN.	OUTLET CONNECTION, IN.	UL RATED CLOSING FLOW, PROPANE (HORIZONTAL POSITION)			DIFFERENTIAL PRESSURE, psid / bar d	WORKING PRESSURE, psig / bar
					Liquid GPM / l/min	Vapor SCFH / SCMh			
						25 psig / 1.7 bar Inlet	100 psig / 6.9 bar Inlet		
F138	Brass	In-Line	1/4 MNPT	1/4 FNPT	1.8 / 6.8	377 / 10.7	641 / 18.2	1.4 / 0.097	250 / 17.2
F202	Brass		Male POL	1/2 SAE Flare	1.9 / 7.2	634 / 17.9	1100 / 31.1	2.6 / 0.18	
F170	Brass	Tanks (Full or Half Coupling)	3/4 MNPT	3/4 FNPT	6.6 / 25.0	1184 / 33.5	2012 / 57.0	1.2 / 0.08	
F100	Brass				8.4 / 31.8	2010 / 56.9	3417 / 96.8	2.4 / 0.17	
F101	Brass				20 / 76.0	3459 / 97.9	5880 / 167	8.5 / 0.59	
F102	Brass		1-1/4 MNPT	1-1/4 FNPT	33 / 125	6300 / 178	10,630 / 301	10.7 / 0.74	
F105	Brass				55 / 208	9982 / 283	16,967 / 480	10.7 / 0.74	
F106	Brass		2 MNPT	2 FNPT	85 / 322	18,513 / 524	31,467 / 891	2.6 / 0.18	
F107	Brass				100 / 379	20,796 / 589	35,349 / 1001	3.6 / 0.25	
F130	Brass	In-Line	1 FNPT	1 FNPT	25 / 94.6	5287 / 150	8986 / 254	3.3 / 0.23	
F131	Brass		1-1/2 FNPT	1-1/2 FNPT	60 / 227	11,694 / 331	19,877 / 563	4.7 / 0.32	
F132	Brass		2 FNPT	2 FNPT	96 / 363	19,874 / 563	33,877 / 959	2.1 / 0.14	
F133	Brass				155 / 587	29,202 / 827	49,718 / 1408	4.2 / 0.29	
F134	Brass	Tanks (Full or Half Coupling)	1-1/2 MNPT x 1 FNPT	1 FNPT	28 / 106	5181 / 147	8806 / 249	2.7 / 0.19	
F135	Brass		2-1/2 MNPT x 1-1/2 FNPT	1-1/2 FNPT	60 / 227	12,000 / 340	20,290 / 575	5.2 / 0.35	
F190	Steel	Tanks <sup>(1)</sup> (Full or Half Coupling)	2 MNPT	2 MNPT x 1-1/4 FNPT	80 / 303	15,400 / 436	26,250 / 743	3.7 / 0.26	
F191	Steel				105 / 397	18,800 / 532	32,000 / 906	8.9 / 0.61	
F194	Steel		3 MNPT	2 MNPT	165 / 625	32,800 / 929	55,950 / 1584	3.1 / 0.21	
F195	Steel				260 / 984	50,650 / 1434	86,350 / 2445	6.9 / 0.48	
F198	Steel		3 MNPT	3 MNPT x 2 FNPT	165 / 625	33,000 / 934	56,250 / 1593	3.1 / 0.21	
F199	Steel				260 / 984	49,500 / 1402	84,350 / 2389	7.1 / 0.49	

1. LPG or NH<sub>3</sub> service.



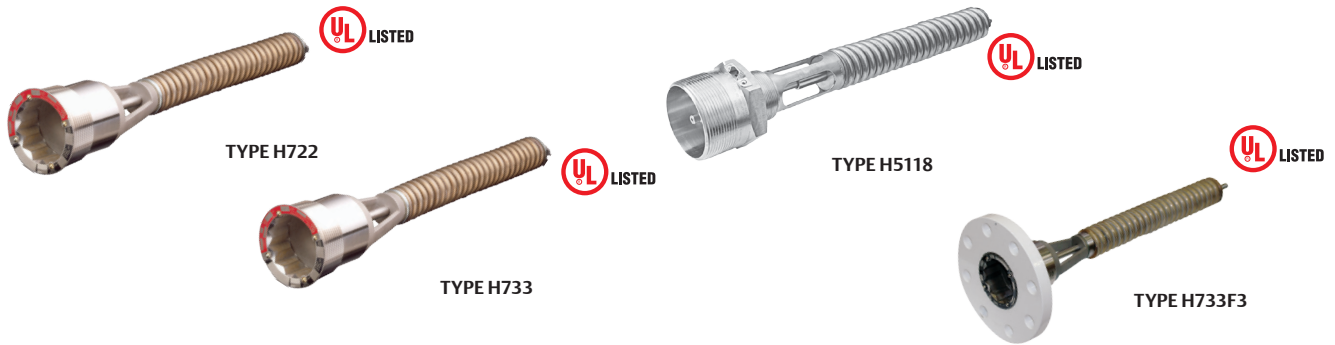

## Relief Valves for Mobile Tanks and Transports

Primarily for trucks transporting LPG, Anhydrous Ammonia (NH<sub>3</sub>) or other compressed gases.

**Types H722, H733 and H5118** stainless steel relief valves resist rust and corrosion, including a 300 Series stainless steel spring for additional resistance to product contaminants. A thickly molded main seal improves service life and resistance to severe applications. Stainless steel makes it easy to remove the valve from the tank for periodic testing (as prescribed by DOT) and permits standard tank couplings instead of the more costly flanged tank openings. The Type H733 has an optional CL300 RF Flange connection. Standard product temperature rating is -20 to 160°F / -29 to 71°C.

**Type H5118:** Semi-Internal relief valve for 2 in. threaded recessed well-head connections on transports.

Tight fitting protective caps (Types P297, P298 and P299) are standard on the valve to ensure no debris blocks the valve discharge. Standard setpoints listed with UL for the Type H722 include 125, 156, 250, 265, 275 and 312 psig / 8.6, 10.8, 17.2, 18.3, 19.0 and 21.5 bar. Standard set points listed with UL for the Types H733 and H5118 include 250 and 265 psig / 17.2 and 18.3 bar. All set points between 100 and 400 psig / 6.9 and 27.6 bar are available with ASME approvals.

A 1-1/2 and 2-1/2 in. hex size (Type P304 or P305) wrench can be inserted into the valve socket when installing/removing the valve to provide a means of attaching a standard wrench.

UL® Approved Internal Relief Valves							
TYPE	CONTAINER CONNECTION, IN.	START-TO-DISCHARGE SETTING		FLOW CAPACITY, SCFM / SCMH AIR		FOR TANK WITH AREA UP TO <sup>(3)</sup> : Ft <sup>2</sup> / m <sup>2</sup>	PROTECTIVE CAP (INCLUDED)
		psig	bar	UL	ASME		
H722-250	2 MNPT <sup>(1)</sup>	250	17.2	3635 / 6176	3203 / 5136	171 / 15.9	Type P297
H722-265		265	18.3	3556 / 6042	3386 / 5753	166 / 15.4	
H722-275		275	19.0	3714 / 6310	3508 / 5960	175 / 16.3	
H733-250	3 MNPT <sup>(2)</sup>	250	17.2	10,150 / 17,245	9369 / 15,918	598 / 55.6	Type P298
H733-265		265	18.3	10,940 / 18,587	9904 / 16,827	655 / 60.9	
H733F3-250	3 in. CL300 RF Flange	250	17.2	10,150 / 17,245	9369 / 15,918	598 / 55.6	Type P298
H733F3-265		265	18.3	10,940 / 18,587	9904 / 16,827	655 / 60.9	
H5118-250 <sup>(4)</sup>	2 MNPT	250	17.2	10,530 / 17,891	9724 / 16,521	625 / 58.1	Type P299
H5118-265 <sup>(4)</sup>		265	18.3	11,300 / 19,199	10,280 / 17,466	681 / 63.3	

1. Order Type P304 (1-1/2 in. hex bar) installation wrench.  
 2. Order Type P305 (2-1/2 in. hex bar) installation wrench.  
 3. Based on UL flow capacities.  
 4. Use with a 3.5 in. hex size installation tool.

Internal Relief Valves				
TYPE	CONTAINER CONNECTION, IN.	SPRING RANGE <sup>(3)</sup> , psig / bar	MATERIAL OPTION	ASME FLOW RATE FACTOR <sup>(4)</sup>
H822-1	2 MNPT <sup>(1)</sup>	100 to 150 / 6.9 to 10.3	<b>Standard - Nitrile (NBR)</b> E - EPDM K - Kalrez® N - Neoprene (CR) V - Viton®	10.18
H822-2	2 MNPT <sup>(1)</sup>	151 to 250 / 10.4 to 17.2		
H822-3	2 MNPT <sup>(1)</sup>	251 to 400 / 17.3 to 27.6		
H833-1	3 MNPT <sup>(2)</sup>	100 to 149 / 6.9 to 10.3		29.77
H833-2	3 MNPT <sup>(2)</sup>	150 to 200 / 10.3 to 13.8		
H833-3	3 MNPT <sup>(2)</sup>	201 to 275 / 13.9 to 19.0		
H833-4	3 MNPT <sup>(2)</sup>	276 to 330 / 19.0 to 22.8		
H833-5	3 MNPT <sup>(2)</sup>	331 to 400 / 22.8 to 27.6		
H833F3-3	3 CL300 RF Flange	201 to 275 / 13.9 to 19.0	<b>Standard - Nitrile (NBR)</b> N - Neoprene (CR)	30.90
H8118-3 <sup>(5)</sup>	2 MNPT	201 to 275 / 13.9 to 19.0		

1. Order Type P304 (1-1/2 in. hex bar) installation wrench.  
 2. Order Type P305 (2-1/2 in. hex bar) installation wrench.  
 3. ASME-Approved set points approved within these spring ranges.  
 4. ASME Flow Capacity (SCFM Air) = [Set Pressure (psig) \* 1.2 + 14.7] \* ASME Flow Rate Factor.  
 5. Use with a 3.5 in. hex size installation tool.

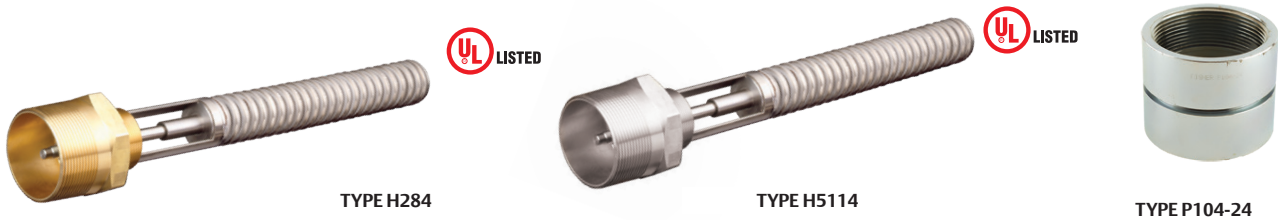

### Relief Valves for Bulk Storage

**Types H284 and H5114** internal spring relief valves can be used in the H500 Combo Joe™ relief valve manifold or as separate units on stationary tanks. The valves are identical except for valve body materials – Type H284 of brass (LPG service) and Type H5114 of 316 Stainless steel (Anhydrous Ammonia (NH<sub>3</sub>) or LPG service). All other components are stainless steel, including a 300 Series Stainless steel spring for additional resistance to product contaminants. A thickly molded main seal improves service life and resistance to severe applications. Flow area is 3.20 sq. in. Standard product temperature rating is -20 to 160°F / -29 to 71°C.

When used in ASME tanks, internal spring relief valves have only the poppet and part of the body outside the tank. The adjusting screw

and all other parts are inside the tank, safe from tampering. Standard setpoints listed with UL for the Type H284 includes 225 and 250 psig / 15.5 and 17.2 bar. Standard setpoints listed with UL for the Type H5114 includes 250 and 265 psig / 17.2 and 18.3 bar. All set points between 100 and 400 psig / 6.9 and 27.6 bar are available with ASME approvals.

Outlet is 3 in. NPT for discharge stack connection. Type P104-24 pipe away adaptor (3 in. FNPT) is available for use with either valve. A 3-1/2 in. wrench can be used when installing or removing the valve. The drain deflector is furnished as standard on both the Types H284 and H5114. The Type P299 Rain Cap ships standard with each valve.

#### UL® Approved Types H284 and H5114 Large Stationary Tank Relief Valves

TYPE <sup>(1)</sup>	CONTAINER CONNECTION, IN.	SERVICE	CONSTRUCTION MATERIAL	START-TO-DISCHARGE SETTING, psig / bar	FLOW CAPACITY, SCFM / SCMH AIR		FOR TANK WITH AREA UP TO <sup>(2)</sup> : Ft <sup>2</sup> / m <sup>2</sup>
					UL	ASME	
H284-225	2 MNPT	LPG	Brass	225 / 15.5	9835 / 16,710	8797 / 14,946	575 / 53.4
H284-250				250 / 17.2	10,530 / 17,891	9724 / 16,521	625 / 58.1
H5114-250		NH <sub>3</sub> or LPG	Stainless Steel	250 / 17.2	10,530 / 17,891	9724 / 16,521	625 / 58.1
H5114-265				265 / 18.3	11,300 / 19,199	10,280 / 17,466	681 / 63.3

1. Use with a 3.5 in. hex size installation tool.  
2. Based on UL flow capacities.

#### Types H884 and H8114 Special Service Large Stationary Tank Relief Valves

TYPE	SPRING RANGE <sup>(2)</sup> , psig / bar	CONTAINER CONNECTION, IN.	MATERIAL OPTION	ASME FLOW RATE FACTOR <sup>(3)</sup>
H884-1	100 to 149 / 6.9 to 10.3	2 MNPT x 3 MNPT <sup>(1)</sup>	<b>Standard</b> - Nitrile (NBR) E - EPDM K - Kalrez® N - Neoprene (CR) V - Viton®	30.90
H884-2	150 to 200 / 10.3 to 13.8			
H884-3	201 to 275 / 13.9 to 19.0			
H884-4	276 to 330 / 19.0 to 22.8			
H884-5	331 to 400 / 22.8 to 27.6			
H8114-1	100 to 149 / 6.9 to 10.3			
H8114-2	150 to 200 / 10.3 to 13.8			
H8114-3	201 to 275 / 13.9 to 19.0			
H8114-4	276 to 300 / 19.0 to 22.8			
H8114-5	331 to 400 / 22.8 to 27.6			

1. Use with a 3.5 in. hex size installation tool.  
2. ASME-Approved set points approved within these spring ranges.  
3. ASME Flow Capacity (SCFM Air) = [Set Pressure (psig) \* 1.2 + 14.7] \* ASME Flow Rate Factor.

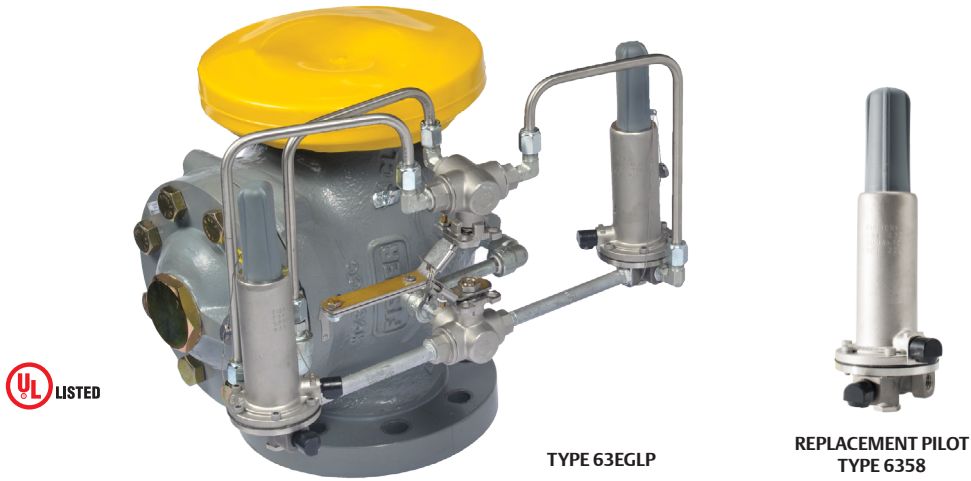

TYPE 63EGLP

REPLACEMENT PILOT  
TYPE 6358

UL® LISTED FOR LPG

### 63EGLP Series Relief Valves

Fisher™ Type 63EGLP relief valve provides superior overpressure protection for large bulk plant applications. Available in steel and stainless steel constructions for LPG and other compressed gas applications. Bringing advanced technology from the petrochemical industry, the Type 63EGLP provides precise and controlled pressure relief in an emergency situation to protect your pressure vessel while simultaneously limiting the amount of product discharged to the atmosphere.

Tight fitting UV resistant caps are standard on all constructions, along with a load-rated lifting sling to assist with lifting and installation. End connections are standard 4 in. CL300 RF bolt patterns. Fisher Type 63EGLP relief valve provides the industries most advanced relief

technologies. The accuracy and repeatability of pilot-operated pressure regulation excercises precise control during relief situations without relying on last-generation pop-style relief mechanics. The Fisher Type 63EGLP is the evolutionary leap forward in bulk plant pressure relief combining safety, durability and serviceability into one superior package.

Type 63EGLP-250 is UL listed for propane (LPG) at 250 psig / 17.2 bar. For other model types and set-point ranges, PED Category IV is also available for set points of 85 to 375 psig / 5.7 to 25.9 bar. The flow port diameter is 4.38 in. and the plug travel height is 2.0 in.

Main body gasket and studs and bolts are not included but can be ordered separately, see Instruction Manual D450321T012.

63EGLP Series Bulk Plant Relief Valves						
TYPE	CONTAINER CONNECTION, IN.	SET PRESSURE		REPLACEMENT PILOT TYPE	FLOW RATE, SCFM / SCMM AIR	
		psig	bar		PER UL-132 <sup>(1)</sup>	PED Cat. IV <sup>(2)</sup>
63EGLP-250	4 CL300 RF Flange <sup>(3)</sup>	250	17.2	6358EBLP-250	38,794 / 1099	N/A
63EGLP-EB1		85 to 140	5.9 to 9.7	6358EBLP-1	N/A	11,929 to 47,164 / 338 to 1336
63EGLP-EB2		130 to 200	9.0 to 13.8	6358EBLP-2		
63EGLP-EB3		180 to 350	12.4 to 24.1	6358EBLP-3		
63EGLP-EBH		250 to 375	17.2 to 26.0	6358EBHLP		

1. Capacity recorded at 20% over set pressure, UL listed for LPG.  
 2. Flow Rate (SCFM Air) = 121.5 \* Set Pressure (psig) + 1602.  
 3. Flange Reducer 4 x 3 in. CL300 RF for 3 in. flange connections available, see Instruction Manual D450321T012.

# External Relief Valves

## Valves

FISHER™



### External Relief Valves

Used on ASME and DOT containers, all working parts of these valves are outside the container connection so they must be protected against mechanical damage.

The external relief valves use Brass as material of construction. Standard product temperature rating is -20 to 160°F / -29 to 71°C.

Protective caps are shipped with Fisher™ external relief valves. Replacement caps may be ordered separately (refer below).

Small External Relief Valves															
TYPE	CONTAINER TYPE	CONTAINER CONNECTION, IN.	START-TO-DISCHARGE PRESSURE		PRESSURE PLUS BUILDUP		FLOW CAPACITY, SCFM / SCMH AIR	ACCESSORY							
			psig	bar	psig	bar		Pipeway Adaptor	Protective Cap						
H110-250 <sup>(1)</sup>	ASME	1/4 MNPT	250	17.2	----	----	310 / 527	----	P206						
H125-250		1/2 MNPT					610 / 1036	----							
H135-250 <sup>(1)</sup>							594 / 1009	P174 <sup>(3)</sup>	----						
H150-250		3/4 MNPT					580 / 985	----							
H160-250 <sup>(1)</sup>			605 / 1028	----											
H185-250 <sup>(1)</sup>			2223 / 3777	----			P145								
H185-275 <sup>(1)</sup>			2456 / 4173	----											
H110-312 <sup>(1)</sup>		1/4 MNPT	390 / 663	----			P206								
H135-312 <sup>(1)</sup>		1/2 MNPT	765 / 1300	----			P174 <sup>(3)</sup>	----							
H160-312		3/4 MNPT	----	----			----								
H123 <sup>(1)</sup>	DOT or Hydrostatic Relief	1/4 MNPT	375	25.9	----	----	----	----							
H148 <sup>(1)</sup>	Hydrostatic	1/2 MNPT	35	2.4	60	4.1	77 / 131	----	P206						
H173 <sup>(1)</sup>		3/4 MNPT								903 / 1534 <sup>(2)</sup>	P174 <sup>(3)</sup>				
H120-35		1/4 MNPT								60	4.1	85	5.9	105 / 178	
H120-60										120	8.3	145	10	165 / 281	
H120-120										150	10.3	180	12	191 / 325	
H120-150										175	12.1	210	14	224 / 380	
H120-175										200	13.8	240	17	262 / 445	
H120-200										225	15.5	270	19	280 / 476	
H120-225										275	19.0	330	23	303 / 515	
H120-275										350	24.1	420	29	445 / 756	
H120-350										----	----	----	----	----	
H124 <sup>(1)</sup>										1/2 MNPT	450	31.0	----	----	----
H144 <sup>(1)</sup>		3/4 MNPT									----	----	----	----	----
H174 <sup>(1)</sup>											----	----	----	----	----

1. Listed under UL® Section 132.  
 2. DOT cylinder water capacity 500 lbs / 227 kg, approved by Bureau of Explosives and CGA.  
 3. 1/2 in. FNPT.



Globe and angle valves are widely used at bulk plants to control gas flow in the piping system, at storage tanks, on trucks and at pumps or compressors. Their body configuration permits installation in a straight section of pipe (globe body) or where it is desired to make a change in piping direction (angle body).

All units have a 1/4 in. FNPT plugged boss in the downstream side of the body. A hydrostatic relief valve (Type H124) or a vent valve (Type J402S) can be installed in this outlet.

Heavy-duty ductile iron (DI A395) valves for either LPG or Anhydrous Ammonia (NH<sub>3</sub>) service. Ranging in size from 1/2 to 3 in. / DN 15 to 80, each valve has spring loaded PTFE chevron packing for an effective seal against leakage. The valves are rated for 400 psig / 27.6 bar WOG and a standard temperature rating of -20 to 160°F / -29 to 71°C.

Valve disc rotation stops as soon as the disc contacts the body seat to help minimize disc wear. Oversize ports in all units give high flow capacity.

**Types N310 and N410** – Heavy-duty ductile iron valves for either LPG or Anhydrous Ammonia (NH<sub>3</sub>) service. Ranging in size from 1/2 to 3 in. / DN 15 to 80 each valve has spring loaded PTFE chevron packing for sealing against leakage. Ball bearing valve disc construction on 1-1/4 in. / DN 32 and larger sizes, gives a strong connection to the stem to protect the disc under back-flow conditions.

**Types N350 and N450** – Economy globe and angle valves for LPG service. With many of the construction features of the Types N310 and N410, these valves can be supplied in 1/2 and 3/4 in. / DN 15 to 80 sizes. PTFE spring-loaded packing provides an effective seal against leakage within the valve’s pressure range.

Globe and Angle Valves					
SERVICE	INLET AND OUTLET CONNECTION, IN. / DN	TYPE			
		Heavy-Duty Version		Economy Version	
		Globe	Angle	Globe	Angle
LPG and NH <sub>3</sub>	1/2 FNPT	N301-04	N401-04	----	----
	3/4 FNPT	N301-06	N401-06	----	----
	1 FNPT	N301-08	N401-08	----	----
	1-1/4 FNPT	N310-10	N410-10	----	----
	1-1/2 FNPT	N310-12	N410-12	----	----
	2 FNPT	N310-16	N410-16	----	----
	3 FNPT	N310-24	N410-24	----	----
	3 / 80 ASME Flange	N310F-24	N410F-24	----	----
LPG	1/2 FNPT	----	----	N350-04	N450-04
	3/4 FNPT	----	----	N350-06	N450-06



G100 SERIES



TYPE G105



Back check valves allow flow in only one direction and are normally closed. They are installed in liquid filling connections on stationary storage tanks, bobtail delivery trucks and liquid transfer lines.

### G100 Series

**G100 Series** – used mainly in tank inlet connections, are offered in two styles of seat construction: metal-to-metal or soft seat. The soft seated construction is for the filling connection on bobtail delivery trucks. Because the valve gives tight shutoff, piping on the bobtail can be depressurized for maintenance or repair without leakage. The G100 Series has a 250 psi / 17.2 bar rating and bubbles at 0.25 psid / 17 mbar d. Standard product temperature rating is -20 to 160°F / -29 to 71°C.

**Type G109** – was designed for in-line service at bulk plants with FNPT connections for easy installations.

### G100 Series Back Check Valves

SEAT CONSTRUCTION	CONTAINER OR INLET CONNECTION, IN.	OUTLET CONNECTION, IN.	PROPANE FLOW CAPACITY AT 10 psig / 0.69 bar DIFFERENTIAL PRESSURE		TYPE	
			GPM	l/min	Brass	Steel
Metal-to-Metal	3/4 MNPT	3/4 FNPT	21	79.5	G100	----
	1-1/4 MNPT	1-1/4 FNPT	55	208	G101	----
	2 MNPT	2 FNPT	150	568	G102	G112
	2 FNPT	2 FNPT	150	568	G109	----
	3 MNPT	3 FNPT	250	946	----	G104
Soft Seat	2 MNPT	2 MNPT and 1-1/4 FNPT	137.5	520	----	G105
	3 FNPT	2 MNPT	254	961	----	G106
	3 MNPT	3 MNPT and 2 FNPT	254	961	----	G107

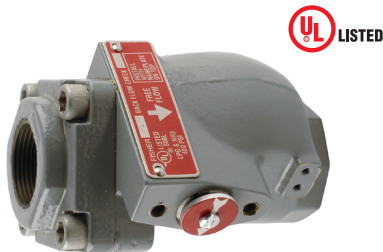

TYPE G201



### G200 Series

**G200 Series** – back check valves are specifically intended for heavy-duty in-line service at the bulk plant's transfer area. The valves are suitable for LPG or Anhydrous Ammonia (NH<sub>3</sub>) service.

Flow moves the spring loaded poppet to the open position as soon as pressure differential is created. When flow stops, the poppet closes. A soft seat construction gives tight shutoff so that piping can be blown down for maintenance.

With a body designed to reduce flow resistance, flow capacity is high. The 2 in. / DN 50 body size gives 350 GPM / 1325 l/min LPG at 10 psig / 0.69 bar differential pressure.

The G200 Series is built to stay on the job with all internal parts of plated steel or stainless steel.

**Type G201** – has a built-in flow indicator mechanism, (see illustration), which can be used to replace sight flow indicators.

## Specifications

### Types G200 and G201

**Pressure Rating:** 400 psig / 28 bar WOG

**Temperature Rating:** -20 to 160°F / -29 to 71°C

**Body:** Ductile iron

**Internal Parts:** Plated steel or stainless steel

**Seat Disc:** Synthetic rubber with metal-to-metal backup

### G200 Series Back Check Valves

SEAT CONSTRUCTION	CONTAINER OR INLET AND OUTLET CONNECTION, IN.	PROPANE FLOW CAPACITY AT 10 psig / 0.69 bar DIFFERENTIAL PRESSURE		TYPE	
		GPM	l/min	Ductile Iron	
				No Flow Indicator	Flow Indicator
Soft Seat	1-1/4 FNPT	190	719	G200-10	G201-10
	2 FNPT	350	1325	G200-16	G201-16
	3 FNPT	800	3028	G200-24	G201-24

## Hose End Valves

**Type N480** – hose end valves are intended for quick opening and closing during bobtail truck deliveries of LPG or Anhydrous Ammonia (NH<sub>3</sub>). The unique design prevents opening unless attached to a 1-3/4 in. ACME filler valve at the tank. The 45° angle body configuration with 1 in. NPT inlet gives maximum handling ease during the transfer operation. Standard product temperature rating is -20 to 160°F / -29 to 71°C.

For increased safety, the Type N480 is designed to stay closed unless connected even with the operating lever in the open position. This prevents accidental opening during hose reel-up or at other times. The fluted coupler permits quick attachment to the filler valve and the operating lever is easy to reach for opening or closing.

**Type M570** – filler hose adaptor, included with the Type N480, permits the hose end valve to be removed from filler valves that fail to close. Standard product temperature rating is -20 to 160°F / -29 to 71°C.

**Type N481** – hose end valves without the Type M570 filler hose adaptor can be supplied for Anhydrous Ammonia (NH<sub>3</sub>) applications. Standard product temperature rating is -20 to 160°F / -29 to 71°C.

**Caution: Other brands of filler hose adaptors should not be used with the Type N480 because they could allow accidental opening of the valve while it is being handled.**

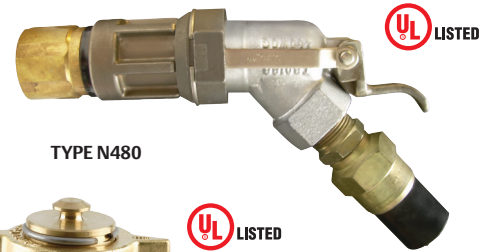

TYPE N480



TYPE D140 OR D141



TYPE D138 OR D139

## Large Filler Valves

Emerson offers large filler valves with heavy-duty construction throughout for rapid filling of ASME tanks or trucks. Thick-walled bodies, formed seat retainers and generous wrenching flats minimize damage to internal parts. The flow channel design offers low resistance-to-flow for increased pump and hose service. Standard product temperature rating is -20 to 160°F / -29 to 71°C.

**Types D138 and D139** – offer single back check valves for use with either a supplementary G Series back check valve or a manual shutoff valve.

**Types D140 and D141** – provide a two-piece design with both an upper and lower back check. The bubble tight upper back check has a resilient seat for maximum service life. A metal-to-metal lower back check protects against loss of product in case of an accident and permits removal of the upper body with the tank under pressure.

Large Filler Valves			
TYPE	CONNECTIONS CONTAINER MNPT x LINE ACME	BACK CHECK STYLE	FILLING CAPACITY GPM / l/min PROPANE AT 10 psi / 0.69 bar DIFFERENTIAL
D138	2 x 2-1/4 in.	Single	105 / 397
D140		Double	100 / 379
D139	3 x 3-1/4 in.	Single	275 / 1041
D141		Double	225 / 852

## Liquid Transfer Valves

The Type N456 attaches to a liquid withdrawal valve or similar constructions. The withdrawal valve is activated by means of a special adaptor on the Type N456 that opens the valve the correct distance to permit liquid transfer from the customer tank to the storage tank. Standard product temperature rating is -20 to 160°F / -29 to 71°C.

**Type N456** – Special 3/4 in. MNPT inlet x 1-3/4 in. male ACME outlet. Consists of a Type N450-06 angle valve, a Type M455 inlet adaptor, a Type M215 outlet adaptor and a cap and chain to keep dirt from entering the valve when it is not in use.



TYPE M455



TYPE N456

**Type M455** – Special 3/4 in. MNPT inlet x 3/4 in. MNPT outlet. Opens the tank's liquid withdrawal valve the correct distance to permit transfer operations. A Nylon (PA) gasket is supplied for a tight seal with the withdrawal valve.

Types N456 and M455 should be used with Types F171\* and F210\* Liquid Withdrawal Valves.

\*Types F171 and F210 valves are obsolete Fisher™ products. Kindly contact your LPG Equipment Distributor for a suitable replacement.

### Bypass Valves for Large Pumps

Designed for bypass on 2 to 4 in. size pumps, the N100 Series is widely used on both LPG and Anhydrous Ammonia (NH<sub>3</sub>) applications. The throttling action of the N100 Series allows only surplus pump discharge to be returned to the tank.

A venturi flow passage gives a boost effect, permitting a greater valve opening for increased flow at the lower pressure build-ups when bypassing full pump output. These features help to give rapid, stable liquid transfer and reduce dangerous pressure pulsations. The valves contain only one moving part - the piston style inner valve.

An external sensing line is not required because tank pressure registers through a hole in the inner valve. Complete field servicing can be made without removing the valve from the piping.

All N100 Series bodies have a 1/4 in. FNPT tapped and plugged boss on the side inlet for either a pressure gauge or a hydrostatic relief valve and have a temperature rating of -20 to 160°F / -29 to 71°C.



N100 SERIES

#### Large Pump Bypass Valves

TYPE	PUMP SIZE, IN.	BODY SIZE, IN.	PSID SETTING		PSID RANGE		
			psig	bar	psig	bar	
N100A-08-1 <sup>(1)</sup>	2	1 FNPT	50	3.4	25 to 75	1.7 to 5.2	
N100A-08-2 <sup>(1)</sup>			115	7.9	50 to 150	3.4 to 10.3	
N100A-10-1 <sup>(1)</sup>	2 or 3	1-1/4 FNPT	50	3.4	25 to 75	1.7 to 5.2	
N100A-10-2 <sup>(1)</sup>			115	7.9	50 to 150	3.4 to 10.3	
N100A-12-1 <sup>(1)</sup>		1-1/2 FNPT	50	3.4	25 to 75	1.7 to 5.2	
N100A-12-2 <sup>(1)</sup>			115	7.9	50 to 150	3.4 to 10.3	
N100-16-1		4	2 FNPT	50	3.4	25 to 75	1.7 to 5.2
N100-16-2			2 FNPT	115	7.9	50 to 150	3.4 to 10.3

1. Only the Type N100As are UL® listed.



## Bypass Valves for Small Pumps

**N110 Series** – is intended for bypass service on the smaller pumps (5 to 40 GPM / 18.9 to 151 l/min) used on stationary tanks or delivery trucks. Suitable for LPG or Anhydrous Ammonia (NH<sub>3</sub>) installations, the valve has an internal sensing orifice and does not require an external sensing line. Standard product temperature rating is -20 to 160°F / -29 to 71°C. A vent opening of the sensing orifice channel allows trapped vapor to escape, eliminating any vapor in the system when the pump is started. The compact size of the N110 Series (less than 6.5 in. / 165 mm overall) permits installation in limited space. A 1/4 in. FNPT tapped and plugged boss on the inlet side of the body can be used to install a hydrostatic relief valve or a pressure gauge. The valve does not have to be removed from the line for servicing; all internal parts can be reached by unscrewing the union nut.



N110 SERIES

Small Pump Bypass Valves							
TYPE	PUMPING CAPACITY		BODY SIZE, IN.	PSID SETTING		PSID RANGE	
	GPM	l/min		psig	bar	psig	bar
N110-06-1	5 to 20	18.9 to 75.7	3/4 FNPT	50	3.4	25 to 75	1.7 to 5.2
N110-08-1	20 to 40	75.7 to 151	1 FNPT				
N110-06-2	5 to 20	18.9 to 75.7	3/4 FNPT	100	6.9	75 to 150	5.2 to 10.3
N110-08-2	20 to 40	75.7 to 151	1 FNPT				

## Backpressure Valves

These valves are soft seated, holding a differential backpressure on liquid meters. A N120 Series backpressure valve is installed after the meter and it holds backpressure on the meter until vapor is forced back to the tank through the vapor eliminator. Standard product temperature rating is -20 to 160°F / -29 to 71°C. In this way vapor cannot form within the meter during liquid delivery.

Intended for smaller pumps, N120 Series are ideal on such applications as cylinder filling installations. All units have a 1/4 in. FNPT tapped and plugged boss on the inlet side of body and can be used for both LPG and Anhydrous Ammonia (NH<sub>3</sub>) service. The N120 Series has a 1/4 in. FNPT connection in the closing cap for attachment of an external sensing line from the tank vapor space or vapor eliminator.



N120 SERIES

Backpressure Valves						
TYPE	LIQUID METER SIZE, IN.	BODY SIZE, IN.	PSID SETTING		PSID RANGE	
			psig	bar	psig	bar
N120-06-3	3/4 or 1	3/4 FNPT	12	0.83	10 to 20	0.69 to 1.4
N120-08-3		1 FNPT				

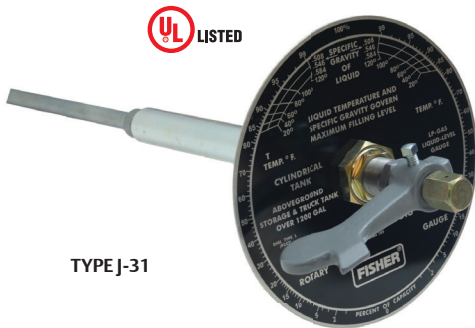

TYPE J-31



## Rotary Gauges

Fisher™ rotary gauges can be used on stationary or mobile tanks to visually indicate the amount of LPG or Anhydrous Ammonia (NH<sub>3</sub>) in the container. They are also used in filling the tank to the proper liquid level. On mobile applications and some large stationary storage tanks, hangers are recommended to support the horizontal length of the dip tube.

The gauge is operated by opening the small bleed orifice when the tube is in the vapor space of the tank. Moving the pointer on the dial causes the end of the tube to move until it contacts liquid in the container. At that point, discharge from the bleed orifice turns from vapor to liquid and the rotary gauge dial gives the volume percentage of liquid in the tank.

**Type J-31** – consists of heavy duty gauges that minimize vibration effects (swaying, bouncing) by a long (68 in. / 1.73 m) stem tube extension. Gauges fit 1 in. / 25.4 mm coupling container connections.

All gauges have stem and dip tubes with an extra large inside diameter. This assures that the correct liquid level can be obtained quickly.

A Nylon (PA) packing sleeve and a friction ring for the pointer indicator gives smooth rotation and long service life. Steel and stainless steel materials resist rust or corrosion. Standard product temperature rating is -20 to 160°F / -29 to 71°C.

### Rotary Gauges

LENGTH, IN. / mm	LPG DIAL >1200 GALLON	LPG DIAL ≤1200 GALLON	NH <sub>3</sub> DIAL >1200 GALLON	NO DIAL >1200 GALLON
68 / 1727	Type J31L-1	Type J31S-1	Type J31A-1	Type J31X-1
69 to 92 / 1753 to 2337	Type J31L-2	Type J31S-2	Type J31A-2	Type J31X-2
93 to 108 / 2362 to 2743	Type J31L-3	Type J31S-3	Type J31A-3	----
109 to 140 / 2769 to 3556	Type J31L-3L	Type J31S-3L	Type J31A-3L	Type J31X-3L
Dial Only	Type P323	Type P322	Type P324	----



TYPE J415-1



TYPE J415

## Liquid Level Vent Valves

**Type J415** – with steel construction, can be used on either LPG or Anhydrous Ammonia (NH<sub>3</sub>) service. They can also be installed on large bulk storage tanks at the maximum filling level. Standard valve comes with a 3/4 in. MNPT container connection and two 1/4 in. FNPT side outlets. Standard product temperature rating is -20 to 160°F / -29 to 71°C.

**Type J415-1** – features the addition of a Type J402S liquid level vent valve and Type J542 (0 to 400 psig / 0 to 27.6 bar) pressure gauge installed.



TYPE J402S



TYPE J403S



## Vent Valves and Fixed Maximum Liquid Level Gauges

Used in all kinds of LPG containers to give positive visual indication of liquid reaching the maximum allowable liquid level. Standard product temperature rating is -20 to 160°F / -29 to 71°C.

**Types J402S and J403S** do not have dip tubes and must be used in containers where a dip tube has been welded in. Stainless steel constructions are for corrosive service.



TYPES J700, J701 OR J702S

## Container Thermometers

Suitable for any size tank in LPG and Anhydrous Ammonia (NH<sub>3</sub>) service, the 2 in. / 51 mm diameter dial reads from -40 to 120°F / -40 to 49°C. They are dustproof and waterproof. Specify J700 Series for a 1/2 in. MNPT by a 4 in. / 102 mm length or Type J701 for a 1/2 in. MNPT by 6 in. / 152 mm length. Type J702S is 1/2 in. MNPT with 2 in. / 51 mm dial and 3 in. / 76 mm stem length and range of -80 to 120°F / -60 to 50°C.

All Thermometers are per ASME B40.1 standard.



### Female ACME Filler Couplings

These couplings allow connection of ACME threads to NPT. One side is 1-1/4 through 4-1/4 in. female ACME. The other side is 3/8 through 3 in. NPT. Available in brass or steel. Standard product temperature rating is -20 to 160°F / -29 to 71°C.

Female ACME Filler Couplings					
FEMALE ACME, IN.	OTHER CONNECTION, IN.	LENGTH, IN. / mm		TYPE	
				Brass	Steel
1-3/4	1/2 MNPT	3 / 76	1	M110	----
	3/4 MNPT	3 / 76	1	M111	M631-6
		6-1/8 / 156	2	----	M635-6
	1 MNPT	3 / 76	1	M112	M631-8
7 / 178		2	----	M635-8	
2-1/4	1-1/4 MNPT	3-1/4 / 83	3	M120 <sup>(1)</sup>	M121
3-1/4	1-1/4 FNPT	1-1/2 / 38	4	M442	----
	2 MNPT	3-3/4 / 95	3	M130 <sup>(1)</sup>	M133
4-1/4	3 MNPT	4-1/2 / 114	3	M664-24	M634-24

1. Steel Nipple



### Female ACME Vapor Return Couplings

Vapor return couplings are available with 1-1/4 through 2-1/4 in. female ACME threads on one side and 3/8 through 1-1/4 in. male NPT threads on the other. Brass or steel construction. Standard product temperature rating is -20 to 160°F / -29 to 71°C.

Female ACME Vapor Return Couplings				
FEMALE ACME, IN.	MALE NPT, IN.	LENGTH, IN. / mm		TYPE
				Brass
1-3/4	1	3-1/4 / 83	5	M151
2-1/4	1-1/4	3-3/8 / 86	7	M160



TYPE M390

### Type M390 POL Filler Coupling

6 in. / 152 mm male POL to 1/4 in. NPT male filler coupling. Brass construction. Replacement O-rings are available. Standard product temperature rating is -20 to 160°F / -29 to 71°C.

POL Filler Coupling			
TYPE	MALE POL	MALE NPT, IN.	LENGTH, IN. / mm
Brass			
M390 <sup>(1)</sup>	Soft Nose	1/4	6 / 152

1. Replacement O-ring T12945T0012.



TYPE M612

### O-rings for Male Adaptors

The 2-1/4 and 3-1/4 in. male adaptors listed above can be supplied with replacement O-rings instead of the conventional washer type of gasket. O-rings give a tighter seal in most cases than the washers. Standard product temperature rating is -20 to 160°F / -29 to 71°C.

O-ring for 2-1/4 in. Adaptors . . . . . T12655T0012

O-ring for 3-1/4 in. Adaptors . . . . . 1H291706562

Adaptor Caps			
TYPE		FEMALE ACME, IN.	MALE ACME, IN.
M611	----	2-1/4	1-3/4
M612	M622	3-1/4	1-3/4
M613	M623	4-1/4	3-1/4



## Single-Piece POL Adaptors

These single-piece brass POL adaptors are available in four styles. Connections are 1/4 through 3/4 in. NPT, 3/8 in. flare and 1/2 in. NPT flare. Brass construction. Standard product temperature rating is -20 to 160°F / -29 to 71°C.

Single Piece POL Adaptors			
TYPE	POL CONNECTION	OTHER CONNECTION, IN.	
Brass			
M286	Female POL	1/2 MNPT	2
M287		3/4 MNPT	2
M357	Male POL	1/2 FNPT	3

## Filler Hose Adaptor

Intended for the outlet of a bobtail truck filling hose, the Type M570 enables the filling hose to be removed if the filler valve fails to close. An integral back check in the adaptor prevents gas from escaping in the event of a failure of the filler valve. The filler valve should be repaired as soon as possible and the Type M570 removed from the filler valve. Standard product temperature rating is -20 to 160°F / -29 to 71°C.

Filler Hose Adaptor			
TYPE	FILLER VALVE CONNECTION, IN.	HOSE END VALVE CONNECTION, IN.	BODY MATERIAL
M570	1-3/4 Female ACME	1-3/4 Male ACME	Brass



## Filler Valve Adaptor

**Type M450A** – allows methanol to be added through conventional designed double back check filler valves with a 1-3/4 in. male ACME filler connection and 3/4 in. FNPT outlet. Standard product temperature rating is -20 to 160°F / -29 to 71°C.

## Seals and Plugs

ACME plugs of various sizes and materials are used in female ACME threads to keep debris out of the piping systems.

Seals and Plugs		
DUST SEAL	PLUG	BODY SIZE, IN.
Type M178 plastic	----	1-1/4 Male ACME
Type M179 plastic	----	1-3/4 Male ACME
Type M180 plastic	----	2-1/4 Male ACME
Type M181 plastic	----	3-1/4 Male ACME
----	Type M535-34 steel	4-1/4 Male ACME



## Female ACME Caps

ACME caps of various sizes and materials are used on male ACME threads to keep debris out of the piping systems. Small sizes are designed for hand tightening. Standard product temperature rating is -20 to 160°F / -29 to 71°C.

Larger sizes are intended to be either tightened by hand or with the use of the Type P1 20B spanner wrench.

Female ACME Caps			
SIZE FEMALE ACME, IN.	TYPE		
	Plastic <sup>(1)</sup>	Brass	Steel
1-1/4	M108	----	----
1-3/4	M109	M229 <sup>(2)</sup>	M219 <sup>(2)</sup>
2-1/4	----	M431	M432
3-1/4	----	M441	M443
4-1/4	----	M605-34	M625-34

1. For LPG only.  
2. Add - 1 suffix for Type P147 ring and chain.

### Clamp Hose Couplings

**Type M3162** – Clamp Hose Couplings, for use on LPG or Anhydrous Ammonia (NH<sub>3</sub>), are designed to be compact yet rugged for long, dependable service. A small boss on the clamp portion of the coupling keeps the bolt from turning when installing, making installation much easier. Each ductile iron unit receives a coat of electro deposition paint. Larger size clamp hose couplings can be furnished with a swivel nut female ACME outlet that reduces weight and space. Standard product temperature rating is -20 to 160°F / -29 to 71°C.



**TYPE M3162  
(STANDARD OUTLET)**

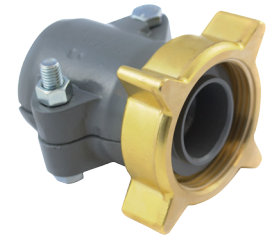

**TYPE M3162-32B  
(SWIVEL NUT OUTLET)**

Clamp Hose Couplings				
TYPE <sup>(2)</sup>	COUPLING STYLE	BODY SIZE, IN.	HOSE I.D., IN. / mm	APPROXIMATE HOSE O.D., IN. / mm
M3162-08	Clamp Type, Standard Outlet	1/2 MNPT	1/2 / 13	15/16 / 24
M3162-12		3/4 MNPT	3/4 / 19	1-1/4 / 32
M3162-16		1 MNPT	1 / 25	1-1/2 / 38
M3162-20		1-1/4 MNPT	1-1/4 / 32	2 / 51
M3162-24		1-1/2 MNPT	1-1/2 / 38	2-1/4 / 57
M3162-32		2 MNPT	2 / 51	2-3/4 / 70
M3162-48		3 MNPT	3 / 76	3-3/4 / 95
M3162-12S <sup>(3)</sup>	Clamp Type, Swivel Nut Outlet	1-3/4 Female ACME	3/4 / 19	1-1/4 / 32
M3162-32S <sup>(3)</sup>		3-1/4 Female ACME	2 / 51	2-3/4 / 70
M3162-32B <sup>(1)</sup>				
M3162-48B	Clamp Type, Swivel Nut Outlet	4-1/4 Female ACME	3 / 76	3-3/4 / 95
M3162-48S	Clamp Type, Swivel Nut Outlet	4-1/4 Female ACME	3 / 76	3-3/4 / 95

1. Has a brass swivel nut with steel or ductile iron nipple. Do not use with Anhydrous Ammonia (NH<sub>3</sub>).  
 2. Maximum allowable working pressure 350 psig / 24.1 bar.  
 3. Has a steel swivel nut with ductile iron nipple.

### Ring and Chain Assemblies

Ring and chain assemblies prevent loss of caps and seals. Available for 1-1/4 in. ACME caps or dust seals.



**TYPE P147 OR P148**



**TYPE P167**

TYPE	FOR CAP OR DUST SEAL SIZE, IN.	FOR FISHER™ TYPE	
		Cap	Dust Seal
P147	1-1/4 ACME	M108	M178
P147 <sup>(1)</sup>	1-3/4 ACME	M109 or M219	----
P148 <sup>(2)</sup>		M109	M179
P148	2-1/4 ACME	----	M180
P167		M431 or M432	----
P183	3-1/4 ACME	----	M181
P167		M441 or M443	----
P167	4-1/4 ACME	M605-34, M625-34M and M535-34	----

1. Type P147 fits 3/4 in. pipe size.  
 2. Type P148 fits 1-1/4 in. pipe size.



TYPE P120B

**Spanner Wrench**

Used to tighten and loosen large female ACME caps and couplings in the 2-1/4, 3-1/4 and 4-1/4 in. sizes.

Spanner Wrench		
TYPE	OVERALL LENGTH, IN. / mm	CONSTRUCTION MATERIAL
P120B	18 / 457	Aluminum



TYPE P520L

**Adjustable Orifice Reamer**

The orifice reamer allows users to clean or ream out orifices of different sizes without changing tools. It allows for a range from 0.125 in. to size no. 52 (0.0635 in.).



TYPE P298

Types P206, P297 and P298 protective caps are used to keep moisture and foreign materials from entering the valves. These units are mounted outside the protective hood on the tank.

Relief Valve Protective Cap	
VALVE TYPE	PROTECTIVE CAP TYPE
H110	P206
H125	
H150	
H148	
H173	
H123	
H120	
H124	
H144	
H174	
H722	P297
H733	P298
H284	P299
H5114	
H5118	



TYPE N201

**Cylinder Filling Valve**

**Type N201** – fills DOT cylinders by weight and stops the gas supply when specified fill weight is reached. Operated by air pressure, it is designed for beam type scales and requires no electrical or mechanical power.

The assembly comes completely piped up and includes special parts that allow the slide weight on the scale to move to zero. A red button appears in the indicator on top of the Type N201 each time a cylinder is filled to the desired weight. Standard product temperature rating is -20 to 160°F / -29 to 71°C.

# DOT Compliance on Jurisdictional Systems? Emerson is Here to Help.

	<p><b>Relief Valve Over Pressure Protection</b></p> <ul style="list-style-type: none"> <li>Keeps the customer running with limited increase in the operating pressure</li> <li>Releases LPG to atmosphere after primary regulator failure</li> </ul>
	<p><b>Monitor System Over Pressure Protection</b></p> <ul style="list-style-type: none"> <li>Highest station capacity than series regulation</li> <li>LPG is not vented to atmosphere</li> <li>Pressure is maintained close to normal set point after failure of the primary regulator</li> </ul>
	<p><b>Series Regulation Over Pressure Protection</b></p> <ul style="list-style-type: none"> <li>Station capacity is reduced</li> <li>Pressure after primary regulator failure is significantly higher than normal operating pressure</li> </ul>

# NFPA58 Compliant? Emerson is Here to Help.

## Liquid Outlet Lines

## Liquid Inlet Lines

## Liquid Inlet and Outlet Lines

Liquid Outlet Lines		Liquid Inlet Lines		Liquid Inlet and Outlet Lines			
Prior Installation	Compliance Options		Prior Installation	Prior Installation	Compliance Options		
Excess flow valve in tank with shutoff valve in piping	Replace excess flow valve with internal valve	Install Type N551 ESV as close as practical to shutoff valve	Back Check valve in tank with shutoff valve in piping	Excess flow valve in tank with shutoff valve in piping	Replace excess flow valve with internal valve	Install Type N551 ESV as close as practical to shutoff valve	Install G200 Series back check valve as close as practical to shutoff valve (inlet only)
<p>TYPE F190 EXCESS FLOW VALVE TYPE N510 SHUTOFF VALVE</p>	<p>TYPE C627 INTERNAL VALVE</p>	<p>TYPE F190 EXCESS FLOW VALVE TYPE N551 EMERGENCY SHUTOFF VALVE</p>	<p>TYPE G105 BACK CHECK VALVE TYPE N510 SHUTOFF VALVE</p>	<p>TYPE F190 EXCESS FLOW VALVE TYPE N510 SHUTOFF VALVE</p>	<p>TYPE C627 INTERNAL VALVE</p>	<p>TYPE F190 EXCESS FLOW VALVE TYPE N551 EMERGENCY SHUTOFF VALVE</p>	<p>TYPE F190 EXCESS FLOW VALVE TYPE G201 BACK CHECK VALVE</p>



## Conversion Factors

### SI Conversion Factors

Multiply	By	To Obtain
<b>Length and Area</b>		
Millimeters	0.0394	Inches
Meters	3.2808	Feet
Sq. Centimeters	0.155	Sq. Inches
Sq. Meters	10.764	Sq. Feet
<b>Volume and Mass</b>		
Cubic Meters	35.315	Cubic Feet
Liters	0.0353	Cubic Feet
Gallons	0.1337	Cubic Feet
Cubic cm.	0.061	Cubic Inches
Liters	2.114	Pints (US)
Liters	0.2642	Gallons (US)
Kilograms	2.2046	Pounds
Tonnes (metric)	1.1024	Tons (US)
<b>Pressure and Flow Rate</b>		
Millibars	0.4018	Inches WC
Ounces/sq. in.	1.733	Inches WC
Inches w.c.	0.0361	Pounds/sq. in.
Bars	14.50	Pounds/sq. in.
Kilopascals	0.1450	Pounds/sq. in.
Kilograms/sq. cm.	14.222	Pounds/sq. in.
Pounds/sq. in.	0.068	Atmospheres
Liters/hr.	0.0353	Cubic Feet/hr.
Cubic Meters/hr	4.403	Gallons/min.
<b>Miscellaneous</b>		
Kilojoules	0.9478	BTU
Calories, kg	3.968	BTU
Watts	3.414	BTU per hour
BTU	0.00001	Therms
Megajoules	0.00948	Therms

### ASME Conversion Factors

Multiply	By	To Obtain
<b>Length and Area</b>		
Inches	25.4	Millimeters
Feet	0.3048	Meters
Sq. Inches	6.4516	Sq. Centimeters
Sq. Feet	0.0929	Sq. Meters
<b>Volume and Mass</b>		
Cubic Feet	0.0283	Cubic Meters
Cubic Feet	28.316	Liters
Cubic Feet	7.481	Gallons
Cubic Inches	16.387	Cubic cm.
Pints (US)	0.473	Liters
Gallons (US)	3.785	Liters
Pounds	0.4535	Kilograms
Tons (US)	0.9071	Tonnes (metric)
<b>Pressure and Flow Rate</b>		
Inches w.c.	2.488	Millibars
Inches w.c.	0.577	Ounces/sq. in.
Pounds/sq. in.	27.71	Inches WC
Pounds/sq. in.	0.0689	Bars
Pounds/sq. in.	6.895	Kilopascals
Pounds/sq. in.	0.0703	Kilograms/sq. cm.
Atmospheres	14.696	Pounds/sq. in.
Cubic Feet/hr.	28.316	Liters/hr.
Gallons/min.	0.2271	Cubic Meters/hr.
<b>Miscellaneous</b>		
BTU	1.055	Kilojoules
BTU	0.252	Calories, kg
BTU per hour	0.293	Watts
Therms	100,000	BTU
Therms	105.5	Megajoules

## Abbreviations

ASME	American Society of Mechanical Engineers	psi	Pounds per Square Inch
BTU per hour	British Thermal Units per Hour	psid	Pounds per Square Inch, Differential Pressure
CFH	Cubic Feet per Hour	psig	Pounds per Square Inch Gauge
CGA	Compressed Gas Association	SAE	Society of Automotive Engineers
CSST	Corrugated Stainless Steel Tubing	SCFH	Standard Cubic Feet per Hour
DBC	Diameter Bolt Circle	SCFM	Standard Cubic Feet per Minute
DOT	Department of Transportation	SCMH	Standard Cubic Meter per Hour
FNPT	Female National Pipe Thread	PTFE	Polytetrafluoroethylene
FPOL	Female POL Portion of CGA 510 Fitting (See POL)	UL®	Underwriters Laboratories Inc.
GPH	Gallons per Hour	UNC	Unified National Course (Defines a thread form/shape)
GPM	Gallons per Minute	UNF LH	Unified National Fine - Left Hand (Defines a thread form/shape)
MNPT	Male National Pipe Thread	WC	Water Column
MPOL	Male POL Portion of CGA 510 Fitting (See POL)	WOG	Water Oil and Gas
NFPA	National Fire Protection Association		
NPT	National Pipe Thread		
POL	Generic Term For A Compressed Gas Association Fitting #510		

### Commercial/Industrial High-Pressure Regulators

Type No.	Description
1098-F2-6351V-2	2 in. CL150 RF Steel Low Pressure Regulator; 5 to 35 psig / 0.34 to 2.4 bar; Type 6351V-2 pilot w/ Viton®; Max Outlet 75 psig / 5.2 bar
1098-F21	2 in. CL300 RF Steel Low Pressure Regulator; 2 to 10 psig / 0.14 to 0.69 bar; Max Outlet 75 psig / 5.2 bar
1098-F22	2 in. CL300 RF Steel Low Pressure Regulator; 0.21 to 2.8 bar; Max Outlet 75 psig / 5.2 bar
1098-F23	2 in. CL300 RF Steel Low Pressure Regulator; 35 to 75 psig / 2.4 to 5.2 bar; Max Outlet 75 psig / 5.2 bar
1098-F3-6351V-2	3 in. CL150 RF Steel Low Pressure Regulator; 5 to 35 psig / 0.34 to 2.4 bar; Type 6351V-2 pilot w/ Viton®; Max Outlet 75 psig / 5.2 bar
1098-F31	3 in. CL300 RF Steel Low Pressure Regulator; 2 to 10 psig / 0.14 to 0.69 bar; Max Outlet 75 psig / 5.2 bar
1098-F32	3 in. CL300 RF Steel Low Pressure Regulator; 3 to 40 psig / 0.21 to 2.8 bar; Max Outlet 75 psig / 5.2 bar
1098-F33	3 in. CL300 RF Steel Low Pressure Regulator; 35 to 75 psig / 2.4 to 5.2 bar; Max Outlet 75 psig / 5.2 bar
1098-F41	4 in. CL300 RF Steel Low Pressure Regulator; 2 to 10 psig / 0.14 to 0.69 bar; Max Outlet 75 psig / 5.2 bar
1098-F42	4 in. CL300 RF Steel Low Pressure Regulator; 3 to 40 psig / 0.21 to 2.8 bar; Max Outlet 75 psig / 5.2 bar
1098-F43	4 in. CL300 RF Steel Low Pressure Regulator; 35 to 75 psig / 2.4 to 5.2 bar; Max Outlet 75 psig / 5.2 bar
1098-L2-6351V-2	2 in. NPT Steel Low Pressure Regulator; 5 to 35 psig / 0.34 to 2.4 bar; Type 6351V-2 pilot w/ Viton®; Max Outlet 75 psig / 5.2 bar
1098H-F21	2 in. CL300 RF Steel; Low Pressure Regulator; 2 to 10 psig / 0.14 to 0.69 bar; Max Outlet 300 psig / 20.7 bar
1098H-F22	2 in. CL300 RF Steel; Low Pressure Regulator; 3 to 40 psig / 0.21 to 2.8 bar; Max Outlet 300 psig / 20.7 bar
1098H-F23	2 in. CL300 RF Steel; High Pressure Regulator; 35 to 125 psig / 2.4 to 8.6 bar; Max Outlet 300 psig / 20.7 bar
1098H-F31	3 in. CL300 RF Steel; Low Pressure Regulator; 2 to 10 psig / 0.14 to 0.69 bar; Max Outlet 300 psig / 20.7 bar
1098H-F32	3 in. CL300 RF Steel; Low Pressure Regulator; 3 to 40 psig / 0.21 to 2.8 bar; Max Outlet 300 psig / 20.7 bar
1098H-F33	3 in. CL300 RF Steel; Low Pressure Regulator; 35 to 125 psig / 2.4 to 8.6 bar; Max Outlet 300 psig / 20.7 bar
1098H-F41	4 in. CL300 RF Steel; Low Pressure Regulator; 2 to 10 psig / 0.14 to 0.69 bar; Max Outlet 300 psig / 20.7 bar
1098H-F42	4 in. CL300 RF Steel; Low Pressure Regulator; 3 to 40 psig / 0.21 to 2.8 bar; Max Outlet 300 psig / 20.7 bar
1098H-F43	4 in. CL300 RF Steel; Low Pressure Regulator; 35 to 125 psig / 2.4 to 8.6 bar; Max Outlet 300 psig / 20.7 bar
1098H-L21	2 in. NPT Cast Iron High Pressure Regulator; 2 to 10 psig / 0.14 to 0.69 bar; Max Outlet 300 psig / 20.7 bar
1098H-L22	2 in. NPT Cast Iron High Pressure Regulator; 3 to 40 psig / 0.21 to 2.8 bar; Max Outlet 300 psig / 20.7 bar
1098H-L23	2 in. NPT Cast Iron High Pressure Regulator; 35 to 125 psig / 2.4 to 8.6 bar; Max Outlet 300 psig / 20.7 bar
1098-L21	2 in. NPT Cast Iron Low Pressure Regulator; 2 to 10 psig / 0.14 to 0.69 bar; Max Outlet 75 psig / 5.2 bar
1098-L22	2 in. NPT Cast Iron Low Pressure Regulator; 3 to 40 psig / 0.21 to 2.8 bar; Max Outlet 75 psig / 5.2 bar
1098-L23	2 in. NPT Cast Iron Low Pressure Regulator; 35 to 75 psig / 2.4 to 5.2 bar; Max Outlet 75 psig / 5.2 bar
1301F-1	1/4 in. FNPT Brass; High Pressure Regulator; 10 to 75 psi / 0.69 to 5.2 bar
1301F-2	1/4 in. FNPT Brass; High Pressure Regulator; 50 to 150 psi / 3.4 to 10.3 bar
1301F-3	1/4 in. FNPT Brass; High Pressure Regulator; 100 to 225 psi / 6.9 to 15.5 bar
1301G-101	1/4 in. FNPT Brass; High Pressure Regulator; 200 to 500 psi / 13.8 to 34.5 bar
627-117	1 in. FNPT Ductile Iron; High Pressure Regulator with Ductile Iron Casing; 3/8 in. port; 15 to 40 psi / 1 to 2.8 bar
627-122	1 in. FNPT Ductile Iron; High Pressure Regulator with Ductile Iron Casing; 1/2 in. port; 15 to 40 psi / 1 to 2.8 bar

Type No.	Description
627-409	3/4 in. FNPT Ductile Iron; High Pressure Regulator; 1/4 in. port; 5 to 20 psi / 0.34 to 1.4 bar
627-414	3/4 in. FNPT Ductile Iron; High Pressure Regulator; 3/8 in. port; 15 to 40 psi / 1 to 2.8 bar
627-415	3/4 in. FNPT Ductile Iron; High Pressure Regulator; 3/8 in. port; 35 to 80 psi / 2.4 to 5.5 bar
627-416	3/4 in. FNPT Ductile Iron; High Pressure Regulator; 3/8 in. port; 70 to 150 psi / 4.8 to 10.3 bar
627-418	3/4 in. FNPT Ductile Iron; High Pressure Regulator; 1/2 in. port; 15 to 40 psi / 1 to 2.8 bar
627-419	3/4 in. FNPT Ductile Iron; High Pressure Regulator; 1/2 in. port; 35 to 80 psi / 2.4 to 5.5 bar
627-420	3/4 in. FNPT Ductile Iron; High Pressure Regulator; 1/2 in. port; 70 to 150 psi / 4.8 to 10.3 bar
627-492	1 in. FNPT Ductile Iron; High Pressure Regulator; 3/8 in. port; 5 to 20 psi / 0.34 to 1.4 bar
627-493	1 in. FNPT Ductile Iron; High Pressure Regulator; 3/8 in. port; 15 to 40 psi / 1 to 2.8 bar
627-494	1 in. FNPT Ductile Iron; High Pressure Regulator; 3/8 in. port; 35 to 80 psi / 2.4 to 5.5 bar
627-495	1 in. FNPT Ductile Iron; High Pressure Regulator; 3/8 in. port; 70 to 150 psi / 4.8 to 10.3 bar
627-496	1 in. FNPT Ductile Iron; High Pressure Regulator; 1/2 in. port; 5 to 20 psi / 0.34 to 1.4 bar
627-497	1 in. FNPT Ductile Iron; High Pressure Regulator; 1/2 in. port; 15 to 40 psi / 1 to 2.8 bar
627-498	1 in. FNPT Ductile Iron; High Pressure Regulator; 1/2 in. port; 35 to 80 psi / 2.4 to 5.5 bar
627-499	1 in. FNPT Ductile Iron; High Pressure Regulator; 1/2 in. port; 70 to 150 psi / 4.8 to 10.3 bar
627-572	2 in. FNPT Ductile Iron; High Pressure Regulator; 3/8 in. port; 5 to 20 psi / 0.34 to 1.4 bar
627-573	2 in. FNPT Ductile Iron; High Pressure Regulator; 3/8 in. port; 15 to 40 psi / 1 to 2.8 bar
627-574	2 in. FNPT Ductile Iron; High Pressure Regulator; 3/8 in. port; 35 to 80 psi / 2.4 to 5.5 bar
627-575	2 in. FNPT Ductile Iron; High Pressure Regulator; 3/8 in. port; 70 to 150 psi / 4.8 to 10.3 bar
627-576	2 in. FNPT Ductile Iron; High Pressure Regulator; 1/2 in. port; 5 to 20 psi / 0.34 to 1.4 bar
627-577	2 in. FNPT Ductile Iron; High Pressure Regulator; 1/2 in. port; 15 to 40 psi / 1 to 2.8 bar
627-578	2 in. FNPT Ductile Iron; High Pressure Regulator; 1/2 in. port; 35 to 80 psi / 2.4 to 5.5 bar
627-579	2 in. FNPT Ductile Iron; High Pressure Regulator; 1/2 in. port; 70 to 150 psi / 4.8 to 10.3 bar
627-5810	3/4 in. FNPT Ductile Iron; High Pressure Regulator; 3/8 in. port; 5 to 20 psi / 0.34 to 1.4 bar; UL® Listed
627-5810V	3/4 in. FNPT Ductile Iron; High Pressure Regulator; 3/8 in. port; 5 to 20 psi / 0.34 to 1.4 bar; UL Listed with Fluorocarbon (FKM) Trim
627-6010	3/4 in. FNPT Ductile Iron; High Pressure Regulator; 1/2 in. port; 35 to 80 psi / 2.4 to 5.5 bar with Nylon (PA) Disc
627-6210	3/4 in. FNPT Ductile Iron; High Pressure Regulator; 1/2 in. port; 5 to 20 psi / 0.34 to 1.4 bar; UL Listed
627-6210V	3/4 in. FNPT Ductile Iron; High Pressure Regulator; 1/2 in. port; 5 to 20 psi / 0.34 to 1.4 bar; UL Listed with Fluorocarbon (FKM) Trim
627-741	3/4 in. FNPT WCC; High Pressure Regulator; 3/8 in. port; 5 to 20 psi / 0.34 to 1.4 bar
627-742	3/4 in. FNPT WCC; High Pressure Regulator; 3/8 in. port; 15 to 40 psi / 1 to 2.8 bar
627-743	3/4 in. FNPT WCC; High Pressure Regulator; 3/8 in. port; 35 to 80 psi / 2.4 to 5.5 bar
627-744	3/4 in. FNPT WCC; High Pressure Regulator; 3/8 in. port; 70 to 150 psi / 4.8 to 10.3 bar
627-745	3/4 in. FNPT WCC; High Pressure Regulator; 1/2 in. port; 5 to 20 psi / 0.34 to 1.4 bar

Commercial/Industrial High-Pressure Regulators (continued)

Type No.	Description
627-746	3/4 in. FNPT WCC; High Pressure Regulator; 1/2 in. port; 15 to 40 psi / 1 to 2.8 bar
627-747	3/4 in. FNPT WCC; High Pressure Regulator; 1/2 in. port; 35 to 80 psi / 2.4 to 5.5 bar
627-748	3/4 in. FNPT WCC; High Pressure Regulator; 1/2 in. port; 70 to 150 psi / 4.8 to 10.3 bar
627-7710	1 in. FNPT Ductile Iron; High Pressure Regulator; 1/2 in. port; 5 to 20 psi / 0.34 to 1.4 bar UL® Listed
627-7710V	1 in. FNPT Ductile Iron; High Pressure Regulator; 1/2 in. port; 5 to 20 psi / 0.34 to 1.4 bar UL Listed with Fluorocarbon (FKM) trim
627-841	1 in. FNPT WCC; High Pressure Regulator 3/8 in. port; 5 to 20 psi / 0.34 to 1.4 bar
627-842	1 in. FNPT WCC; High Pressure Regulator; 3/8 in. port; 15 to 40 psi / 1 to 2.8 bar
627-843	1 in. FNPT WCC; High Pressure Regulator; 3/8 in. port; 35 to 80 psi / 2.4 to 5.5 bar
627-844	1 in. FNPT WCC; High Pressure Regulator; 3/8 in. port; 70 to 150 psi / 4.8 to 10.3 bar
627-845	1 in. FNPT WCC; High Pressure Regulator; 1/2 in. port; 5 to 20 psi / 0.34 to 1.4 bar
627-846	1 in. FNPT WCC; High Pressure Regulator; 1/2 in. port; 15 to 40 psi / 1 to 2.8 bar
627-847	1 in. FNPT WCC; High Pressure Regulator; 1/2 in. port; 35 to 80 psi / 2.4 to 5.5 bar
627-848	1 in. FNPT WCC; High Pressure Regulator; 1/2 in. port; 70 to 150 psi / 4.8 to 10.3 bar
627-941	2 in. FNPT WCC; High Pressure Regulator; 3/8 in. port; 5 to 20 psi / 0.34 to 1.4 bar
627-942	2 in. FNPT WCC; High Pressure Regulator; 3/8 in. port; 15 to 40 psi / 1 to 2.8 bar
627-943	2 in. FNPT WCC; High Pressure Regulator; 3/8 in. port; 35 to 80 psi / 2.4 to 5.5 bar
627-944	2 in. FNPT WCC; High Pressure Regulator; 3/8 in. port; 70 to 150 psi / 4.8 to 10.3 bar
627-945	2 in. FNPT WCC; High Pressure Regulator; 1/2 in. port; 5 to 20 psi / 0.34 to 1.4 bar
627-946	2 in. FNPT WCC; High Pressure Regulator; 1/2 in. port; 15 to 40 psi / 1 to 2.8 bar
627-947	2 in. FNPT WCC; High Pressure Regulator; 1/2 in. port; 35 to 80 psi / 2.4 to 5.5 bar
627-948	2 in. FNPT WCC; High Pressure Regulator; 1/2 in. port; 70 to 150 psi / 4.8 to 10.3 bar
627H-142	2 in. FNPT WCC; High Pressure Regulator; 3/16 in. port; 240 to 500 psi / 16.5 to 34.5 bar
627H-88	1 in. FNPT WCC; High Pressure Regulator; 1/8 in. port; 140 to 250 psi / 9.7 to 17.2 bar
627H-96	1 in. FNPT wcc; High Pressure Regulator, 1/2 in. port, 140 to 250 psi / 9.7 to 17.2 bar
627M-195	3/4 in. FNPT WCC; High Pressure Monitor Regulator; 1/2 in. port; 5 to 20 psi / 0.34 to 1.4 bar
627M-196	3/4 in. FNPT WCC; High Pressure Monitor Regulator; 1/2 in. port; 15 to 40 psi / 1 to 2.8 bar
627M-197	3/4 in. FNPT WCC; High Pressure Monitor Regulator; 1/2 in. port; 35 to 80 psi / 2.4 to 5.5 bar
627M-198	3/4 in. FNPT WCC; High Pressure Monitor Regulator; 1/2 in. port; 70 to 150 psi / 4.8 to 10.3 bar
627M-267	2 in. FNPT Ductile Iron; High Pressure Monitor Regulator; 1/2 in. port; 5 to 20 psi / 0.34 to 1.4 bar
627M-268	2 in. FNPT Ductile Iron; High Pressure Monitor Regulator; 1/2 in. port; 15 to 40 psi / 1 to 2.8 bar
627M-269	2 in. FNPT Ductile Iron; High Pressure Monitor Regulator; 1/2 in. port; 35 to 80 psi / 2.4 to 5.5 bar
627M-270	2 in. FNPT Ductile Iron; High Pressure Monitor Regulator; 1/2 in. port; 70 to 150 psi / 4.8 to 10.3 bar
627M-421	3/4 in. FNPT Ductile Iron; High Pressure Monitor Regulator; 1/2 in. port; 5 to 20 psi / 0.34 to 1.4 bar
627M-422	3/4 in. FNPT Ductile Iron; High Pressure Monitor Regulator; 1/2 in. port; 15 to 40 psi / 1 to 2.8 bar

Type No.	Description
627M-423	3/4 in. FNPT Ductile Iron; High Pressure Monitor Regulator; 1/2 in. port; 35 to 80 psi / 2.4 to 5.5 bar
627M-424	3/4 in. FNPT Ductile Iron; High Pressure Monitor Regulator; 1/2 in. port; 70 to 150 psi / 4.8 to 10.3 bar
627M-471	1 in. FNPT Ductile Iron; High Pressure Monitor Regulator; 1/2 in. port; 5 to 20 psi / 0.34 to 1.4 bar
627M-472	1 in. FNPT Ductile Iron; High Pressure Monitor Regulator; 1/2 in. port; 15 to 40 psi / 1 to 2.8 bar
627M-473	1 in. FNPT Ductile Iron; High Pressure Monitor Regulator; 1/2 in. port; 35 to 80 psi / 2.4 to 5.5 bar
627M-474	1 in. FNPT Ductile Iron; High Pressure Monitor Regulator; 1/2 in. port; 70 to 150 psi / 4.8 to 10.3 bar
627M-645	1 in. FNPT WCC; High Pressure Monitor Regulator; 1/2 in. port; 5 to 20 psi / 0.34 to 1.4 bar
627M-646	1 in. FNPT WCC; High Pressure Monitor Regulator; 1/2 in. port; 15 to 40 psi / 1 to 2.8 bar
627M-647	1 in. FNPT WCC; High Pressure Monitor Regulator; 1/2 in. port; 35 to 80 psi / 2.4 to 5.5 bar
627M-648	1 in. FNPT WCC; High Pressure Monitor Regulator; 1/2 in. port; 70 to 150 psi / 4.8 to 10.3 bar
627M-745	2 in. FNPT WCC; High Pressure Monitor Regulator; 1/2 in. port; 5 to 20 psi / 0.34 to 1.4 bar
627M-746	2 in. FNPT WCC; High Pressure Monitor Regulator; 1/2 in. port; 15 to 40 psi / 1 to 2.8 bar
627M-747	2 in. FNPT WCC; High Pressure Monitor Regulator; 1/2 in. port; 35 to 80 psi / 2.4 to 5.5 bar
627M-748	2 in. FNPT WCC; High Pressure Monitor Regulator; 1/2 in. port; 70 to 150 psi / 4.8 to 10.3 bar
627R-113	3/4 in. FNPT Ductile Iron; High Pressure Regulator with Relief; 3/8 in. port; 5 to 20 psi / 0.34 to 1.4 bar
627R-114	3/4 in. FNPT Ductile Iron; High Pressure Regulator with Relief; 3/8 in. port; 15 to 40 psi / 1 to 2.8 bar
627R-115	3/4 in. FNPT Ductile Iron; High Pressure Regulator with Relief; 3/8 in. port; 35 to 80 psi / 2.4 to 5.5 bar
627R-116	3/4 in. FNPT Ductile Iron; High Pressure Regulator with Relief; 3/8 in. port; 70 to 150 psi / 4.8 to 10.3 bar
627R-117	3/4 in. FNPT Ductile Iron; High Pressure Regulator with Relief; 1/2 in. port; 5 to 20 psi / 0.34 to 1.4 bar
627R-118	3/4 in. FNPT Ductile Iron; High Pressure Regulator with Relief; 1/2 in. port; 15 to 40 psi / 1 to 2.8 bar
627R-119	3/4 in. FNPT Ductile Iron; High Pressure Regulator with Relief; 1/2 in. port; 35 to 80 psi / 2.4 to 5.5 bar
627R-120	3/4 in. FNPT Ductile Iron; High Pressure Regulator with Relief; 1/2 in. port; 70 to 150 psi / 4.8 to 10.3 bar
627R-193	1 in. FNPT Ductile Iron; High Pressure Regulator with Relief; 3/8 in. port; 5 to 20 psi / 0.34 to 1.4 bar
627R-194	1 in. FNPT Ductile Iron; High Pressure Regulator with Relief; 3/8 in. port; 15 to 40 psi / 1 to 2.8 bar
627R-195	1 in. FNPT Ductile Iron; High Pressure Regulator with Relief; 3/8 in. port; 35 to 80 psi / 2.4 to 5.5 bar
627R-196	1 in. FNPT Ductile Iron; High Pressure Regulator with Relief; 3/8 in. port; 70 to 150 psi / 4.8 to 10.3 bar
627R-197	1 in. FNPT Ductile Iron; High Pressure Regulator with Relief; 1/2 in. port; 5 to 20 psi / 0.34 to 1.4 bar
627R-198	1 in. FNPT Ductile Iron; High Pressure Regulator with Relief; 1/2 in. port; 15 to 40 psi / 1 to 2.8 bar
627R-199	1 in. FNPT Ductile Iron; High Pressure Regulator with Relief; 1/2 in. port; 35 to 80 psi / 2.4 to 5.5 bar
627R-200	1 in. FNPT Ductile Iron; High Pressure Regulator with Relief; 1/2 in. port; 70 to 150 psi / 4.8 to 10.3 bar
627R-273	2 in. FNPT Ductile Iron; High Pressure Regulator with Relief; 3/8 in. port; 5 to 20 psi / 0.34 to 1.4 bar
627R-274	2 in. FNPT Ductile Iron; High Pressure Regulator with Relief; 3/8 in. port; 15 to 40 psi / 1 to 2.8 bar

### Commercial/Industrial High-Pressure Regulators (continued)

Type No.	Description
627R-275	2 in. FNPT Ductile Iron; High Pressure Regulator with Relief; 3/8 in. port; 35 to 80 psi / 2.4 to 5.5 bar
627R-276	2 in. FNPT Ductile Iron; High Pressure Regulator with Relief; 3/8 in. port; 70 to 150 psi / 4.8 to 10.3 bar
627R-277	2 in. FNPT Ductile Iron; High Pressure Regulator with Relief; 1/2 in. port; 5 to 20 psi / 0.34 to 1.4 bar
627R-278	2 in. FNPT Ductile Iron; High Pressure Regulator with Relief; 1/2 in. port; 15 to 40 psi / 1 to 2.8 bar
627R-279	2 in. FNPT Ductile Iron; High Pressure Regulator with Relief; 1/2 in. port; 35 to 80 psi / 2.4 to 5.5 bar
627R-280	2 in. FNPT Ductile Iron; High Pressure Regulator with Relief; 1/2 in. port; 70 to 150 psi / 4.8 to 10.3 bar
627R-61	2 in. FNPT WCC; High Pressure Monitor Regulator with Relief; 3/8 in. port; 5 to 20 psi / 0.34 to 1.4 bar
627R-62	2 in. FNPT WCC; High Pressure Monitor Regulator with Relief; 3/8 in. port; 15 to 40 psi / 1 to 2.8 bar
627R-63	2 in. FNPT WCC; High Pressure Monitor Regulator with Relief; 3/8 in. port; 35 to 80 psi / 2.4 to 5.5 bar
627R-64	2 in. FNPT WCC; High Pressure Monitor Regulator with Relief; 3/8 in. port; 70 to 150 psi / 4.8 to 10.3 bar
627R-65	2 in. FNPT WCC; High Pressure Monitor Regulator with Relief; 1/2 in. port; 5 to 20 psi / 0.34 to 1.4 bar
627R-658	1 in. FNPT DI; High Pressure Regulator with Relief; 1/2 in. port; 15 to 40 psi / 1 to 2.8 bar
627R-66	2 in. FNPT WCC; High Pressure Regulator with Relief; 1/2 in. port; 15 to 40 psi / 1 to 2.8 bar
627R-67	2 in. FNPT WCC; High Pressure Monitor Regulator with Relief; 1/2 in. port; 35 to 80 psi / 2.4 to 5.5 bar
627R-68	2 in. FNPT WCC; High Pressure Monitor Regulator with Relief; 1/2 in. port; 70 to 150 psi / 4.8 to 10.3 bar
627R-817	3/4 in. FNPT WCC; High Pressure Regulator with Relief; 3/8 in. port; 5 to 20 psi / 0.34 to 1.4 bar
627R-818	3/4 in. FNPT WCC; High Pressure Regulator with Relief; 3/8 in. port; 15 to 40 psi / 1 to 2.8 bar
627R-819	3/4 in. FNPT WCC; High Pressure Regulator with Relief; 3/8 in. port; 35 to 80 psi / 2.4 to 5.5 bar
627R-820	3/4 in. FNPT WCC; High Pressure Regulator with Relief; 3/8 in. port; 70 to 150 psi / 4.8 to 10.3 bar
627R-821	3/4 in. FNPT WCC; High Pressure Regulator with Relief; 1/2 in. port; 5 to 20 psi / 0.34 to 1.4 bar
627R-822	3/4 in. FNPT WCC High Pressure Regulator with Relief; 1/2 in. port; 15 to 40 psi / 1 to 2.8 bar
627R-823	3/4 in. FNPT WCC; High Pressure Regulator with Relief; 1/2 in. port; 35 to 80 psi / 2.4 to 5.5 bar
627R-824	3/4 in. FNPT WCC; High Pressure Regulator with Relief; 1/2 in. port; 70 to 150 psi / 4.8 to 10.3 bar
627R-913	1 in. FNPT WCC; High Pressure Regulator with Relief; 3/8 in. port; 5 to 20 psi / 0.34 to 1.4 bar
627R-914	1 in. FNPT WCC; High Pressure Regulator with Relief; 3/8 in. port; 15 to 40 psi / 1 to 2.8 bar
627R-915	1 in. FNPT WCC; High Pressure Regulator with Relief; 3/8 in. port; 35 to 80 psi / 2.4 to 5.5 bar
627R-916	1 in. FNPT WCC; High Pressure Regulator with Relief; 3/8 in. port; 70 to 150 psi / 4.8 to 10.3 bar
627R-917	1 in. FNPT WCC; High Pressure Regulator with Relief; 1/2 in. port; 5 to 20 psi / 0.34 to 1.4 bar
627R-918	1 in. FNPT WCC; High Pressure Regulator with Relief; 1/2 in. port; 15 to 40 psi / 1 to 2.8 bar
627R-919	1 in. FNPT WCC; High Pressure Regulator with Relief; 1/2 in. port; 35 to 80 psi / 2.4 to 5.5 bar
627R-920	1 in. FNPT WCC; High Pressure Regulator with Relief; 1/2 in. port; 70 to 150 psi / 4.8 to 10.3 bar
627W-13	3/4 in. FNPT WCC; High Pressure Liquid Regulator; 1/2 in. port; 10 to 20 psi / 0.69 to 1.4 bar
627W-14	3/4 in. FNPT WCC; High Pressure Liquid Regulator; 1/2 in. port; 15 to 40 psi / 1 to 2.8 bar

Type No.	Description
627W-15	3/4 in. FNPT WCC; High Pressure Liquid Regulator; 1/2 in. port; 35 to 80 psi / 2.4 to 5.5 bar
627W-16	3/4 in. FNPT WCC; High Pressure Liquid Regulator; 1/2 in. port; 70 to 150 psi / 4.8 to 10.3 bar
627W-37	1 in. FNPT WCC; High Pressure Liquid Regulator; 1/2 in. port; 10 to 20 psi / 0.69 to 1.4 bar
627W-38	1 in. FNPT WCC; High Pressure Liquid Regulator; 1/2 in. port; 15 to 40 psi / 1 to 2.8 bar
627W-39	1 in. FNPT WCC; High Pressure Liquid Regulator; 1/2 in. port; 35 to 80 psi / 2.4 to 5.5 bar
627W-40	1 in. FNPT WCC; High Pressure Liquid Regulator; 1/2 in. port; 70 to 150 psi / 4.8 to 10.3 bar
627W-61	2 in. FNPT WCC; High Pressure Liquid Regulator; 1/2 in. port; 10 to 20 psi / 0.69 to 1.4 bar
627W-62	2 in. FNPT WCC; High Pressure Liquid Regulator; 1/2 in. port; 15 to 40 psi / 1 to 2.8 bar
627W-63	2 in. FNPT WCC; High Pressure Liquid Regulator; 1/2 in. port; 35 to 80 psi / 2.4 to 5.5 bar
627W-64	2 in. FNPT WCC; High Pressure Liquid Regulator; 1/2 in. port; 70 to 150 psi / 4.8 to 10.3 bar
630-104-78	2 in. FNPT Cast Iron; High Pressure Regulator; 1/2 in. port; 8 to 20 psi / 0.55 to 1.4 bar; UL® Listed
630-122	2 in. FNPT Cast Iron; High Pressure Regulator; 1/4 in. port; 46 to 95 psi / 3.2 to 6.6 bar; Nylon (PA) Disc
630-311	1 in. FNPT Cast Iron; High Pressure Regulator; 1/2 in. port; 3 to 10 psi / 0.21 to 0.69 bar
630-312	1 in. FNPT Cast Iron; High Pressure Regulator; 1/2 in. port; 8 to 20 psi / 0.55 to 1.4 bar
630-313	1 in. FNPT Cast Iron; High Pressure Regulator; 1/2 in. port; 17 to 30 psi / 1.2 to 2.1 bar
630-314	1 in. FNPT Cast Iron; High Pressure Regulator; 1/2 in. port; 27 to 40 psi / 1.9 to 2.8 bar
630-315	1 in. FNPT Cast Iron; High Pressure Regulator; 1/2 in. port; 27 to 50 psi / 1.9 to 3.4 bar
630-316	1 in. FNPT Cast Iron; High Pressure Regulator; 1/2 in. port; 46 to 95 psi / 3.2 to 6.6 bar
630-317	1 in. FNPT Cast Iron; High Pressure Regulator; 1/2 in. port; 90 to 150 psi / 6.2 to 10.3 bar
630-318	1 in. FNPT Cast Iron; High Pressure Regulator; 1/2 in. port; 150 to 200 / 10.3 to 13.8 bar psi
630-319	1 in. FNPT Cast Iron; High Pressure Regulator; 1/2 in. port; 200 to 275 psi / 13.8 to 19 bar
630-321	2 in. FNPT Cast Iron; High Pressure Regulator; 1/2 in. port; 3 to 10 psi / 0.21 to 0.69 bar
630-323	2 in. FNPT Cast Iron; High Pressure Regulator; 1/2 in. port; 17 to 30 psi / 1.2 to 2.1 bar
630-324	2 in. FNPT Cast Iron; High Pressure Regulator; 1/2 in. port; 27 to 40 psi / 1.9 to 2.8 bar
630-325	2 in. FNPT Cast Iron; High Pressure Regulator; 1/2 in. port; 27 to 50 psi / 1.9 to 3.4 bar
630-326	2 in. FNPT Cast Iron; High Pressure Regulator; 1/2 in. port; 46 to 95 psi / 3.2 to 6.6 bar
630-327	2 in. FNPT Cast Iron; High Pressure Regulator; 1/2 in. port; 90 to 150 psi / 6.2 to 10.3 bar
630-328	2 in. FNPT Cast Iron; High Pressure Regulator; 1/2 in. port; 150 to 200 psi / 10.3 to 13.8 bar
630-329	2 in. FNPT Cast Iron; High Pressure Regulator; 1/2 in. port; 200 to 275 psi / 13.8 to 19 bar
630-8004	1 in. FNPT WCC; High Pressure Regulator; 1/2 in. port; 3 to 10 psi / 0.21 to 0.69 bar
630-8008	1 in. FNPT WCC; High Pressure Regulator; 1/2 in. port; 8 to 20 psi / 0.55 to 1.4 bar
630-8012	1 in. FNPT WCC; High Pressure Regulator; 1/2 in. port; 17 to 30 psi / 1.2 to 2.1 bar
630-8016	1 in. FNPT WCC; High Pressure Regulator; 1/2 in. port; 27 to 40 psi / 1.9 to 2.8 bar

Commercial/Industrial High-Pressure Regulators (continued)

Type No.	Description
630-8020	1 in. FNPT WCC; High Pressure Regulator; 1/2 in. port; 27 to 50 psi / 1.9 to 3.4 bar
630-8024	1 in. FNPT WCC; High Pressure Regulator; 1/2 in. port; 46 to 95 psi / 3.2 to 6.6 bar
630-8028	1 in. FNPT WCC; High Pressure Regulator; 1/2 in. port; 90 to 150 psi / 6.2 to 10.3 bar
630-8032	1 in. FNPT WCC; High Pressure Regulator; 1/2 in. port; 150 to 200 psi / 10.3 to 13.8 bar
630-8036	1 in. FNPT WCC; High Pressure Regulator; 1/2 in. port; 200 to 275 psi / 13.8 to 19 bar
630-8044	2 in. FNPT WCC; High Pressure Regulator; 1/2 in. port; 3 to 10 psi / 0.21 to 0.69 bar
630-8048	2 in. FNPT WCC; High Pressure Regulator; 1/2 in. port; 8 to 20 psi / 0.55 to 1.4 bar
630-8052	2 in. FNPT WCC; High Pressure Regulator; 1/2 in. port; 17 to 30 psi / 1.2 to 2.1 bar
630-8056	2 in. FNPT WCC; High Pressure Regulator; 1/2 in. port; 27 to 40 psi / 1.9 to 2.8 bar
630-8060	2 in. FNPT WCC; High Pressure Regulator; 1/2 in. port; 27 to 50 psi / 1.9 to 3.4 bar
630-8064	2 in. FNPT WCC; High Pressure Regulator; 1/2 in. port; 46 to 95 psi / 3.2 to 6.6 bar
630-8067	2 in. FNPT WCC; High Pressure Regulator; 3/8 in. port; 90 to 150 psi / 6.2 to 10.3 bar
630-8068	2 in. FNPT WCC; High Pressure Regulator; 1/2 in. port; 90 to 150 psi / 6.2 to 10.3 bar
630-8072	2 in. FNPT WCC; High Pressure Regulator; 1/2 in. port; 150 to 200 psi / 10.3 to 13.8 bar
630-8080	2 in. FNPT WCC; High Pressure Regulator; 1/2 in. port; 275 to 500 psi / 19 to 34.5 bar
64-222	1/2 in. FNPT Aluminum; High Pressure Regulator; 35 to 100 psi / 2.4 to 6.9 bar
64-33	1/2 in. FNPT Aluminum; High Pressure Regulator; 3 to 15 psi / 0.21 to 1 bar
64-35	1/2 in. FNPT Aluminum; High Pressure Regulator; 5 to 35 psi / 0.34 to 2.4 bar
64-36	1/2 in. FNPT Aluminum; High Pressure Regulator; 30 to 60 psi / 2.1 to 4.1 bar
64KB-222	1/2 in. FNPT High Pressure Regulator for NH <sub>3</sub> Service; 35 to 100 psi / 2.4 to 6.9 bar
64KB-33	1/2 in. FNPT High Pressure Regulator for NH <sub>3</sub> Service; 3 to 15 psi / 0.21 to 1 bar
64KB-34	1/2 in. FNPT High Pressure Regulator for NH <sub>3</sub> Service; 5 to 20 psi / 0.34 to 1.4 bar
64KB-35	1/2 in. FNPT High Pressure Regulator for NH <sub>3</sub> Service; 5 to 35 psi / 0.34 to 2.4 bar
64KB-36	1/2 in. FNPT High Pressure Regulator for NH <sub>3</sub> Service; 30 to 60 psi / 2.1 to 4.1 bar
64SR-122	1/2 in. FNPT; Automatic Changeover Regulator with Relief; 5 to 20 psi / 0.34 to 1.4 bar
64SR-21	1/2 in. FNPT Aluminum; High Pressure Regulator with Relief; 3 to 15 psi / 0.21 to 1 bar
64SR-22	1/2 in. FNPT Aluminum; High Pressure Regulator with Relief; 5 to 20 psi / 0.34 to 1.4 bar
64SR-23	1/2 in. FNPT Aluminum; High Pressure Regulator with Relief; 5 to 35 psi / 0.34 to 2.4 bar
64SR-24	1/2 in. FNPT Aluminum; High Pressure Regulator with Relief; 30 to 60 psi / 2.07 to 4.14 bar
67CD-100	1/4 in. FNPT; High Pressure Regulator; 5 to 20 psi / 0.34 to 1.4 bar; Dial Cap
67CD-101	1/4 in. FNPT; High Pressure Regulator; 5 to 35 psi / 0.34 to 2.4 bar; Dial Cap
67CD-102	1/4 in. FNPT; High Pressure Regulator; 20 to 50 psi / 1.4 to 3.4 bar; Dial Cap
67CD-103	1/4 in. FNPT; High Pressure Regulator; 40 to 100 psi / 2.8 to 6.9 bar; Dial Cap
67CD-104	1/4 in. FNPT; High Pressure Regulator with Type M318; 0 to 60 psi / 0 mbar to 4.1 bar; Dial Cap

Type No.	Description
67CD-115	1/4 in. FNPT; High Pressure Regulator with Types M318 and M104; 0 to 30 Gauge; 0 to 20 psi / 0 mbar to 2.1 bar; Dial Cap
67CD-116	1/4 in. FNPT; High Pressure Regulator with Types M318 and M104; 0 to 30 Gauge; 0 to 35 psi / 0 mbar to 2.1 bar; Dial Cap
67CH-150	1/4 in. FNPT; High Pressure Regulator; with Types M318, M104 and J502; 0 to 60 psi / 0 mbar to 4.1 bar; Handwheel
67CH-741	1/4 in. FNPT; High Pressure Regulator; 50 to 135 psi / 3.4 to 9.3 bar; Handwheel
67CH-742	1/4 in. FNPT; High Pressure Regulator; 30 to 60 psi / 2.1 to 4.1 bar; Handwheel
67CH-743	1/4 in. FNPT; High Pressure Regulator; 3 to 35 psi / 0.21 to 2.4 bar; Handwheel
67CH-743XB	1/4 in. FNPT; High Pressure Regulator; 3 to 35 psi / 0.21 to 2.4 bar; Handwheel; set at 15 psi / 1 bar
67CH-745	1/4 in. FNPT; High Pressure Regulator; 3 to 20 psi / 0.21 to 1.4 bar; Handwheel
67CH-747	1/4 in. FNPT; High Pressure Regulator; 3 to 20 psi / 0.21 to 1.4 bar; Handwheel, with 1/4 NPT Exhaust Vent
67CH-751	1/4 in. FNPT; High Pressure Regulator; Type M318; 3 to 20 psi / 0.21 to 1.4 bar; Handwheel
67CH-80	1/4 in. FNPT; High Pressure Regulator; with Type J504; 30 to 60 psi / 2.1 to 4.1 bar; Handwheel
67CH-90	1/4 in. FNPT High Pressure Regulator; with Type J501; 3 to 35 psi / 0.21 to 2.4 bar; Handwheel
67CN-104	1/4 in. FNPT; High Pressure Regulator; 15 psi / 1 bar setpoint; Non-Adjustable
67CN-105	1/4 in. FNPT; High Pressure Regulator; 20 psi / 1.4 bar setpoint; Non-Adjustable
67CN-106	1/4 in. FNPT; High Pressure Regulator; 10 psi / 0.69 bar setpoint; Non-Adjustable
67CW-120	1/4 in. FNPT; High Pressure Regulator; with Types M104 and F181; 30 to 60 psi / 2.1 to 4.1 bar
67CW-62	1/4 in. FNPT; High Pressure Regulator; with Type J503; 50 to 100 psi / 3.4 to 6.9 bar
67CW-683	1/4 in. FNPT; High Pressure Regulator; 3 to 20 psi / 0.21 to 1.4 bar
67CW-684	1/4 in. FNPT; High Pressure Regulator; 3 to 35 psi / 0.21 to 2.4 bar
67CW-685	1/4 in. FNPT; High Pressure Regulator; 30 to 60 psi / 2.1 to 4.1 bar
67CW-687	1/4 in. FNPT; High Pressure Regulator; with Type M318; 3 to 35 psi / 0.21 to 2.4 bar
67CW-701	1/4 in. FNPT; High Pressure Regulator; 50 to 135 psi / 3.4 to 9.3 bar
749B-21	1/2 in. FNPT; Changeover Manifold; Supply setting 15 psi / 1 bar; Reserve Setting 5 psi / 0.34 bar
99-502PH	2 in. FNPT Cast Iron; High Pressure Regulator; 1-1/8 in. port; 1 to 5 psi / 69 mbar to 0.34 bar; Max P, 300 psig / 20.7 bar
99-502PHM	2 in. FNPT Cast Iron; High Pressure Regulator; 1-1/8 in. port; 1 to 5 psi / 69 mbar to 0.34 bar; Max P, 300 psig / 20.7 bar
99-502PHO	2 in. FNPT Cast Iron; High Pressure Regulator; 1-1/8 in. port; O-ring Seat; 1 to 5 psi / 69 mbar to 0.34 bar; Max P, 250 psig / 17.2 bar
99-502PHOM	2 in. FNPT Cast Iron; High Pressure Regulator; 1-1/8 in. port; O-ring Seat; 1 to 5 psi / 69 mbar to 0.34 bar; Max P, 250 psig / 17.2 bar
99-503PH	2 in. FNPT Cast Iron; High Pressure Regulator; 1-1/8 in. port; 2 to 10 psi / 0.14 to 0.69 bar; Max P, 300 psig / 20.7 bar
99-503PHM	2 in. FNPT Cast Iron; High Pressure Regulator; 1-1/8 in. port; 2 to 10 psi / 0.14 to 0.69 bar; Max P, 300 psig / 20.7 bar
99-503PHO	2 in. FNPT Cast Iron; High Pressure Regulator; 1-1/8 in. port; O-ring Seat; 2 to 10 psi / 0.14 to 0.69 bar; Max P, 250 psig / 17.2 bar
99-503PHOM	2 in. FNPT Cast Iron; High Pressure Regulator; 1-1/8 in. port; O-ring Seat; 2 to 10 psi / 0.14 to 0.69 bar; Max P, 250 psig / 17.2 bar
99-504PH	2 in. FNPT Cast Iron; High Pressure Regulator; 1-1/8 in. port; 5 to 15 psi / 0.34 to 1 bar; Max P, 300 psig / 20.7 bar
99-504PHM	2 in. FNPT Cast Iron; High Pressure Regulator; 1-1/8 in. port; 5 to 15 psi / 0.34 to 1 bar; Max P, 300 psig / 20.7 bar
99-504PHO	2 in. FNPT Cast Iron; High Pressure Regulator; 1-1/8 in. port; O-ring Seat; 5 to 15 psi / 0.34 to 1 bar; Max P, 250 psig / 17.2 bar
99-504PHOM	2 in. FNPT Cast Iron; High Pressure Regulator; 1-1/8 in. port; O-ring Seat; 5 to 15 psi / 0.34 to 1 bar; Max P, 250 psig / 17.2 bar

### Commercial/Industrial High-Pressure Regulators (continued)

Type No.	Description
99-505PH	2 in. FNPT Cast Iron; High Pressure Regulator; 1-1/8 in. port; 10 to 20 psi / 0.69 to 1.4 bar; Max P, 300 psig / 20.7 bar
99-505PHM	2 in. FNPT Cast Iron; High Pressure Monitor Regulator; 1-1/8 in. port; 10 to 20 psi / 0.69 to 1.4 bar; Max P, 300 psig / 20.7 bar
99-505PHO	2 in. FNPT Cast Iron; High Pressure Regulator; 1-1/8 in. port; O-ring Seat; 10 to 20 psi / 0.69 to 1.4 bar; Max P, 250 psig / 17.2 bar
99-505PHOM	2 in. FNPT Cast Iron; High Pressure Monitor Regulator; 1-1/8 in. port; O-ring Seat; 10 to 20 psi / 0.69 to 1.4 bar; Max P, 250 psig / 17.2 bar
99-510P	2 in. FNPT Cast Iron; High Pressure Regulator; 7/8 in. port; 1/4 to 2 psi / 17 mbar to 0.14 bar; Max P, 250 psig / 17.2 bar
99-510PM	2 in. FNPT Cast Iron; High Pressure Monitor Regulator; 7/8 in. port; 1/4 to 2 psi / 17 mbar to 0.14 bar; Max P, 250 psig / 17.2 bar
99-511P	2 in. FNPT Cast Iron; High Pressure Regulator; 7/8 in. port; 1 to 5 psi / 69 mbar to 0.34 bar; Max P, 250 psig / 17.2 bar
99-511PM	2 in. FNPT Cast Iron; High Pressure Monitor Regulator; 7/8 in. port; 1 to 5 psi / 69 mbar to 0.34 bar; Max P, 250 psig / 17.2 bar
99-512P	2 in. FNPT Cast Iron; High Pressure Regulator; 7/8 in. port; 5 to 15 psi / 0.34 to 1 bar; Max P, 250 psig / 17.2 bar
99-512PM	2 in. FNPT Cast Iron; High Pressure Monitor Regulator; 7/8 in. port; 5 to 15 psi / 0.34 to 1 bar; Max P, 250 psig / 17.2 bar
99-513P	2 in. FNPT Cast Iron; High Pressure Regulator; 7/8 in. port; 2 to 10 psi / 0.14 to 0.69 bar; Max P, 250 psig / 17.2 bar
99-513PM	2 in. FNPT Cast Iron; High Pressure Monitor Regulator; 7/8 in. port; 2 to 10 psi / 0.14 to 0.69 bar; Max P, 250 psig / 17.2 bar
99-515P	2 in. FNPT Cast Iron; High Pressure Regulator; 7/8 in. port; 10 to 20 psi / 0.69 to 1.4 bar; Max P, 250 psig / 17.2 bar
99-515PM	2 in. FNPT Cast Iron; High Pressure Monitor Regulator; 7/8 in. port; 10 to 20 psi / 0.69 to 1.4 bar; Max P, 250 psig / 17.2 bar
99-901P	2 in. FNPT Cast Iron; High Pressure Regulator; 1-1/8 in. port; 10 to 65 psi / 0.69 to 4.5 bar; Max P, 150 psig / 10.3 bar
99-901PH	2 in. FNPT Cast Iron; High Pressure Regulator; 1-1/8 in. port; 10 to 65 psi / 0.69 to 4.5 bar; Max P, 300 psig / 20.7 bar
99-901PHM	2 in. FNPT Cast Iron; High Pressure Monitor Regulator; 1-1/8 in. port; 10 to 65 psi / 0.69 to 4.5 bar; Max P, 300 psig / 20.7 bar
99-901PHO	2 in. FNPT Cast Iron; High Pressure Regulator; 1-1/8 in. port; O-ring Seat; 10 to 65 psi / 2.4 to 6.9 bar; Max P, 250 psig / 17.2 bar
99-901PHOM	2 in. FNPT Cast Iron; High Pressure Monitor Regulator; 1-1/8 in. port; O-ring Seat; 10 to 65 psi / 2.4 to 6.9 bar; Max P, 250 psig / 17.2 bar
99-901PM	2 in. FNPT Cast Iron; High Pressure Monitor Regulator; 1-1/8 in. port; 10 to 65 psi / 2.4 to 6.9 bar; Max P, 150 psig / 10.3 bar
99-903P	2 in. FNPT Cast Iron; High Pressure Regulator; 7/8 in. port; 10 to 65 psi / 2.4 to 6.9 bar; Max P, 250 psig / 17.2 bar
99-903PM	2 in. FNPT Cast Iron; HP Monitor Regulator; 7/8 in. port; 10 to 65 psi / 0.69 to 4.5 bar; Max P, 250 psig / 17.2 bar
99-924	2 in. FNPT Cast Iron; High Pressure Regulator; 7/8 in. port; 35 to 100 psi / 2.4 to 6.9 bar; Max P, 250 psig / 17.2 bar
99-924PM	2 in. FNPT Cast Iron; High Pressure Monitor Regulator; 7/8 in. port; 35 to 100 psi / 2.4 to 6.9 bar; Max P, 250 psig / 17.2 bar
99-926	2 in. FNPT Cast Iron; High Pressure Regulator; 1-1/8 in. port; 35 to 100 psi / 2.4 to 6.9 bar; Max P, 150 psig / 10.3 bar
99-926PH	2 in. FNPT Cast Iron; High Pressure Regulator; 1-1/8 in. port; 35 to 100 psi / 2.4 to 6.9 bar; Max P, 300 psig / 20.7 bar
99-926PHM	2 in. FNPT Cast Iron; High Pressure Monitor Regulator; 1-1/8 in. port; 35 to 100 psi / 2.4 to 6.9 bar; Max P, 300 psig / 20.7 bar
99-926PHO	2 in. FNPT Cast Iron; High Pressure Regulator; 1-1/8 in. port; O-ring Seat; 35 to 100 psi / 2.4 to 6.9 bar; Max P, 250 psig / 17.2 bar
99-926PHOM	2 in. FNPT Cast Iron; High Pressure Monitor Regulator; 1-1/8 in. port; O-ring Seat; 35 to 100 psi / 2.4 to 6.9 bar; Max P, 250 psig / 17.2 bar
99-926PM	2 in. FNPT Cast Iron; High Pressure Monitor Regulator; 1-1/8 in. port; 35 to 100 psi / 2.4 to 6.9 bar; Max P, 150 psig / 10.3 bar
99F-502PH	2 in. CL300 RF High Pressure Regulator; 1-1/8 in. port; 1 to 5 psi / 69 mbar to 0.34 bar; Max P, 300 psig / 20.7 bar
99F-502PHM	2 in. CL300 RF High Pressure Monitor Regulator; 1-1/8 in. port; 1 to 5 psi / 69 mbar to 0.34 bar; Max P, 300 psig / 20.7 bar
99F-503PH	2 in. CL300 RF High Pressure Regulator; 1-1/8 in. port; 2 to 10 psi / 0.14 to 0.69 bar; Max P, 300 psig / 20.7 bar
99F-503PHM	2 in. CL300 RF High Pressure Monitor Regulator; 1-1/8 in. port; 2 to 10 psi / 0.14 to 0.69 bar; Max P, 300 psig / 20.7 bar

Type No.	Description
99F-504PH	2 in. CL300 RF High Pressure Regulator; 1-1/8 in. port; 5 to 15 psi / 0.34 to 1 bar; Max P, 300 psig / 20.7 bar
99F-504PHM	2 in. CL300 RF High Pressure Monitor Regulator; 1-1/8 in. port; 5 to 15 psi / 0.34 to 1 bar; Max P, 300 psig / 20.7 bar
99F-505PH	2 in. CL300 RF High Pressure Regulator; 1-1/8 in. port; 10 to 20 psi / 0.69 to 1.4 bar; Max P, 300 psig / 20.7 bar
99F-505PHM	2 in. CL300 RF High Pressure Monitor Regulator; 1-1/8 in. port; 10 to 20 psi / 0.69 to 1.4 bar; Max P, 300 psig / 20.7 bar
99F-510P	2 in. CL300 RF High Pressure Regulator; 7/8 in. port; 1/4 to 2 psi / 17 mbar to 0.14 bar; Max P, 250 psig / 17.2 bar
99F-510PM	2 in. CL300 RF High Pressure Monitor Regulator; 7/8 in. port; 1/4 to 2 psi / 17 mbar to 0.14 bar; Max P, 250 psig / 17.2 bar
99F-511P	2 in. CL300 RF High Pressure Regulator; 7/8 in. port; 1 to 5 psi / 69 mbar to 0.34 bar; Max P, 250 psig / 17.2 bar
99F-511PM	2 in. CL300 RF High Pressure Monitor Regulator; 7/8 in. port; 1 to 5 psi / 69 mbar to 0.34 bar; Max P, 250 psig / 17.2 bar
99F-512P	2 in. CL300 RF High Pressure Regulator; 7/8 in. port; 5 to 15 psi / 0.34 to 1 bar; Max P, 250 psig / 17.2 bar
99F-512PM	2 in. CL300 RF High Pressure Monitor Regulator; 7/8 in. port; 5 to 15 psi / 0.34 to 1 bar; Max P, 250 psig / 17.2 bar
99F-513P	2 in. CL300 RF High Pressure Regulator; 7/8 in. port; 2 to 10 psi / 0.14 to 0.69 bar; Max P, 250 psig / 17.2 bar
99F-513PM	2 in. CL300 RF High Pressure Monitor Regulator; 7/8 in. port; 2 to 10 psi / 0.14 to 0.69 bar; Max P, 250 psig / 17.2 bar
99F-515P	2 in. CL300 RF High Pressure Regulator; 7/8 in. port; 10 to 20 psi / 0.69 to 1.4 bar; Max P, 250 psig / 17.2 bar
99F-515PM	2 in. CL300 RF High Pressure Monitor Regulator; 7/8 in. port; 10 to 65 psi / 0.69 to 4.5 bar; Max P, 250 psig / 17.2 bar
99F-901PH	2 in. CL300 RF High Pressure Regulator; 1-1/8 in. port; 10 to 65 psi / 0.69 to 4.5 bar; Max P, 300 psig / 20.7 bar
99F-901PHM	2 in. CL300 RF High Pressure Monitor Regulator; 1-1/8 in. port; 10 to 65 psi / 0.69 to 4.5 bar; Max P, 300 psig / 20.7 bar
99F-903P	2 in. CL300 RF High Pressure Regulator; 7/8 in. port; 10 to 65 psi / 0.69 to 4.5 bar; Max P, 250 psig / 17.2 bar
99F-903PM	2 in. CL300 RF High Pressure Monitor Regulator; 7/8 in. port; 10 to 65 psi / 0.69 to 4.5 bar; Max P, 250 psig / 17.2 bar
99F-924	2 in. CL300 RF High Pressure Regulator; 7/8 in. port; 35 to 100 psi / 2.4 to 6.9 bar; Max P, 250 psig / 17.2 bar
99F-924PM	2 in. CL300 RF High Pressure Monitor Regulator; 7/8 in. port; 35 to 100 psi / 2.4 to 6.9 bar; Max P, 250 psig / 17.2 bar
99F-926PH	2 in. CL300 RF High Pressure Regulator; 1-1/8 in. port; 35 to 100 psi / 2.4 to 6.9 bar; Max P, 300 psig / 20.7 bar
99F-926PHM	2 in. CL300 RF High Pressure Monitor Regulator; 1-1/8 in. port; 35 to 100 psi / 2.4 to 6.9 bar; Max P, 300 psig / 20.7 bar
MR95H-103	1/4 in. FNPT WCC, Regulator, 70 to 150 psig / 4.8 to 10.3 bar, Trim 2, Max Inlet/Outlet 300 psig / 20.7 bar
MR95H-11	1 in. FNPT Cast Iron, Regulator, 25 to 75 psig / 1.7 to 5.2 bar, Trim 10, Max Inlet/Outlet 250 psig / 17.2 bar
MR95H-3	1/4 in. FNPT Cast Iron, Regulator, 70 to 150 psig / 4.8 to 10.3 bar, Trim 10, Max Inlet/Outlet 250 psig / 17.2 bar
MR95H-35	1/4 in. FNPT Cast Iron, Regulator, 70 to 150 psig / 4.8 to 10.3 bar, Trim 1, Max Inlet/Outlet 250 psig / 17.2 bar
MR95H-4	1/2 in. FNPT Cast Iron, Reg, 15 to 30 psig / 1 to 2.1 bar, Trim 10, Max Inlet/Outlet 250 psig / 17.2 bar
MR95H-40	1/2 in. FNPT Cast Iron, Reg, 25 to 75 psig / 1.7 to 5.2 bar, Trim 1, Max Inlet/Outlet 250 psig / 17.2 bar
MR95H-5	1/2 in. FNPT Cast Iron, Reg, 25 to 75 psig / 1.7 to 5.2 bar, Trim 10, Max Inlet/Outlet 250 psig / 17.2 bar
MR95H-53	1 in. FNPT Cast Iron, Reg, 70 to 150 psig / 4.8 to 10.3 bar, Trim 1, Max Inlet/Outlet 250 psig / 17.2 bar
MR95H-8	3/4 in. FNPT Cast Iron, Reg, 25 to 75 psig / 1.7 to 5.2 bar, Trim 10, Max Inlet/Outlet 250 psig / 17.2 bar
R130-21	Small Commercial Changeover Manifold; 1/4 x 1/4 in.
133H-1	2 in. FNPT Cast Iron; High Pressure Regulator; 1.5 to 3 psi / 0.10 to 0.21 bar
133H-2	2 in. FNPT Cast Iron; High Pressure Regulator; 2 to 5 psi / 0.14 to 0.34 bar
133H-3	2 in. FNPT Cast Iron; High Pressure Regulator; 5 to 10 psi / 0.34 to 0.69 bar

Commercial/Industrial Low-Pressure Regulators

Type No.	Description
133H-4	2 in. CL125 FF Cast Iron; High Pressure Regulator; 1.5 to 3 psi / 0.10 to 0.21 bar
133H-5	2 in. CL125 FF Cast Iron; High Pressure Regulator; 2 to 5 psi / 0.14 to 0.34 bar
133H-6	2 in. CL125 FF Cast Iron; High Pressure Regulator; 5 to 10 psi / 0.34 to 0.69 bar
133HP-AC1	2 in. FNPT Cast Iron; Dist. Serv. Self Op Regulator; 6 to 20 psi / 0.41 to 1.38 bar
133HP-AC2	2 in. FNPT Cast Iron; Dist. Serv. Self Op Regulator; 16 to 30 psi / 1.1 to 2.1 bar
133HP-AC3	2 in. FNPT Cast Iron; Dist. Serv. Self Op Regulator; 26 to 40 psi / 1.8 to 2.8 bar
133HP-AC4	2 in. FNPT Cast Iron; Dist. Serv. Self Op Regulator; 36 to 50 psi / 2.5 to 3.4 bar
133HP-AC5	2 in. FNPT Cast Iron; Dist. Serv. Self Op Regulator; 45 to 60 psi / 3.2 to 4.1 bar
133HP-AC6	2 in. FNPT Cast Iron; Dist. Serv. Self Op Regulator; 2 to 5 psi / 0.14 to 0.34 bar
133HP-AC7	2 in. FNPT Cast Iron; Dist. Serv. Self Op Regulator; 4.5 to 10 psi / 0.34 to 0.69 bar
133HP-AD1	2 in. CL125 FF Cast Iron; Dist. Serv. Self Op Regulator; 6 to 20 psi / 0.41 to 1.38 bar
133HP-AD2	2 in. CL125 FF Cast Iron; Dist. Serv. Self Op Regulator; 16 to 30 psi / 1.1 to 2.1 bar
133HP-AD3	2 in. CL125 FF Cast Iron; Dist. Serv. Self Op Regulator; 26 to 40 psi / 1.8 to 2.8 bar
133HP-AD4	2 in. CL125 FF Cast Iron; Dist. Serv. Self Op Regulator; 36 to 50 psi / 2.5 to 3.4 bar
133HP-AD5	2 in. CL125 FF Cast Iron; Dist. Serv. Self Op Regulator; 45 to 60 psi / 3.2 to 4.1 bar
133HP-AD6	2 in. CL125 FF Cast Iron; Dist. Serv. Self Op Regulator; 2 to 5 psi / 0.14 to 0.34 bar
133HP-AD7	2 in. CL125 FF Cast Iron; Dist. Serv. Self Op Regulator; 4.5 to 10 psi / 0.34 to 0.69 bar
133HP-BE2	2 in. CL150 RF Steel; Dist. Serv. Self Op Reg; 16 to 30 psi / 1.1 to 2.1 bar
133L-1	2 in. FNPT Cast Iron; Low Pressure Regulator; 2 to 4 in. w.c. / 5 to 19 mbar
133L-10	2 in. CL125 FF Cast Iron; Low Pressure Regulator; 8.5 to 18 in. w.c. / 21 to 45 mbar
133L-11	2 in. CL125 FF Cast Iron; Low Pressure Regulator; 14 to 28 in. w.c. / 35 to 70 mbar
133L-12	2 in. CL125 FF Cast Iron; Low Pressure Regulator; 3/4 to 2 psi / 52 mbar to 0.14 bar
133L-2	2 in. FNPT Cast Iron; Low Pressure Regulator; 3.5 to 6 in. w.c. / 8.7 to 15 mbar
133L-3	2 in. FNPT Cast Iron; Low Pressure Regulator; 5 to 9 in. w.c. / 12 to 22 mbar
133L-4	2 in. FNPT Cast Iron; Low Pressure Regulator; 8.5 to 18 in. w.c. / 21 to 45 mbar
133L-6	2 in. FNPT Cast Iron; Low Pressure Regulator; 3/4 to 2 psi / 52 mbar to 0.14 bar
133L-7	2 in. CL125 FF Cast Iron; Low Pressure Regulator; 2 to 4 in. w.c. / 5 to 10 mbar
133L-8	2 in. CL125 FF Cast Iron; Low Pressure Regulator; 3.5 to 6 in. w.c. / 8.7 to 15 mbar
133L-9	2 in. CL125 FF Cast Iron; Low Pressure Regulator; 5 to 9 in. w.c. / 12 to 22 mbar
299H-101	1-1/2 in. FNPT Cast Iron; Pilot Operated Regulator; Internal; 3/4 in. port; 7 to 20 in. w.c. / 17 to 50 mbar
299H-102	2 in. FNPT Cast Iron; Pilot Operated Regulator; Internal; 3/4 in. port; 7 to 20 in. w.c. / 17 to 50 mbar
299H-103	1-1/2 in. FNPT Cast Iron; Pilot Operated Regulator; Internal; 3/4 in. port; 5 to 16 psig / 0.34 to 1.1 bar
299H-104	2 in. FNPT Cast Iron; Pilot Operated Regulator; Internal; 3/4 in. port; 5 to 16 psig / 0.34 to 1.1 bar

Type No.	Description
299H-105	1-1/2 in. FNPT Cast Iron; Pilot Operated Regulator; External; 3/4 in. port; 7 to 20 in. w.c. / 17 to 50 mbar
299H-106	2 in. FNPT Cast Iron; Pilot Operated Regulator; External; 3/4 in. port; 7 to 20 in. w.c. / 17 to 50 mbar
299H-107	1-1/2 in. FNPT Cast Iron; Pilot Operated Regulator; External; 3/4 in. port; 5 to 16 psig / 0.34 to 1.1 bar
299H-108	2 in. FNPT Cast Iron; Pilot Operated Regulator; External; 3/4 in. port; 5 to 16 psig / 0.34 to 1.1 bar
299H-109	1-1/2 in. FNPT Cast Iron; Pilot Operated Regulator; External; 14 to 35 psig / 0.97 to 2.4 bar
299H-110	1-1/2 in. FNPT Cast Iron; Pilot Operated Regulator; 14 to 35 psig / 0.97 to 2.4 bar
299H-MAF	1-1/2 in. FNPT Cast Iron; Commercial Service Regulator; External; 1/4 x 3/8 in. port; 1 to 3.25 psi / 69 mbar to 0.22 bar
299H-MAG	1-1/2 in. FNPT Cast Iron; Commercial Service Regulator; External; 3/8 in. port; 1 to 3.25 psi / 69 mbar to 0.22 bar
299H-MAH	1-1/2 in. FNPT Cast Iron; Commercial Service Regulator; External; 1/2 in. port; 1 to 3.25 psi / 69 mbar to 0.22 bar
299H-MAJ	1-1/2 in. FNPT Cast Iron; Commercial Service Regulator; External; 3/4 in. port; 1 to 3.25 psi / 69 mbar to 0.22 bar
299H-MAK	1-1/2 in. FNPT Cast Iron; Commercial Service Regulator; External; 1 in. port; 1 to 3.25 psi / 69 mbar to 0.22 bar
299H-MAL	1-1/2 in. FNPT Cast Iron; Commercial Service Regulator; External; 1-3/16 in. port; 1 to 3.25 psi / 69 mbar to 0.22 bar
299H-MBF	2 in. FNPT Cast Iron; Commercial Service Regulator; External; 1/4 x 3/8 in. port; 1 to 3.25 psi / 69 mbar to 0.22 bar
299H-MBG	2 in. FNPT Cast Iron; Commercial Service Regulator; External; 3/8 in. port; 1 to 3.25 psi / 69 mbar to 0.22 bar
299H-MBH	2 in. FNPT Cast Iron; Commercial Service Regulator; External; 1/2 in. port; 1 to 3.25 psi / 69 mbar to 0.22 bar
299H-MBJ	2 in. FNPT Cast Iron; Commercial Service Regulator; External; 3/4 in. port; 1 to 3.25 psi / 69 mbar to 0.22 bar
299H-MBK	2 in. FNPT Cast Iron; Commercial Service Regulator; External; 1 in. port; 1 to 3.25 psi / 69 mbar to 0.22 bar
299H-MBL	2 in. FNPT Cast Iron; Commercial Service Regulator; External; 1-3/16 in. port; 1 to 3.25 psi / 69 mbar to 0.22 bar
299H-NAF	1-1/2 in. FNPT Cast Iron; Commercial Service Regulator; Internal; 1/4 x 3/8 in. port; 1 to 3.25 psi / 69 mbar to 0.22 bar
299H-NAG	1-1/2 in. FNPT Cast Iron; Commercial Service Regulator; Internal; 3/8 in. port; 1 to 3.25 psi / 69 mbar to 0.22 bar
299H-NBH	2 in. FNPT Cast Iron; Commercial Service Regulator; Internal; 1/2 in. port; 1 to 3.25 psi / 69 mbar to 0.22 bar
299H-NBJ	2 in. FNPT Cast Iron; Commercial Service Regulator; Internal; 3/4 in. port; 1 to 3.25 psi / 69 mbar to 0.22 bar
299H-NBK	2 in. FNPT Cast Iron; Commercial Service Regulator; Internal; 1 in. port; 1 to 3.25 psi / 69 mbar to 0.22 bar
299H-NBL	2 in. FNPT Cast Iron; Commercial Service Regulator; Internal; 1-3/16 in. port; 1 to 3.25 psi / 69 mbar to 0.22 bar
299H-PAG	1-1/2 in. FNPT Cast Iron; Commercial Service Regulator; Dual; 3/8 in. port; 1 to 3.25 psi / 69 mbar to 0.22 bar
299H-PAJ	1-1/2 in. FNPT Cast Iron; Commercial Service Regulator; Dual; 3/4 in. port; 1 to 3.25 psi / 69 mbar to 0.22 bar
299H-PAL	1-1/2 in. FNPT Cast Iron; Commercial Service Regulator; Dual; 1-3/16 in. port; 1 to 3.25 psi / 69 mbar to 0.22 bar
299H-PBH	2 in. FNPT Cast Iron; Commercial Service Regulator; Dual; 1/2 in. port; 1 to 3.25 psi / 69 mbar to 0.22 bar
299H-PBJ	2 in. FNPT Cast Iron; Commercial Service Regulator; Dual; 3/4 in. port; 1 to 3.25 psi / 69 mbar to 0.22 bar
299H-PBK	2 in. FNPT Cast Iron; Commercial Service Regulator; Dual; 1 in. port; 1 to 3.25 psi / 69 mbar to 0.22 bar
299H-PBL	2 in. FNPT Cast Iron; Commercial Service Regulator; Dual; 1-3/16 in. port; 1 to 3.25 psi / 69 mbar to 0.22 bar
912-101	1/4 x 3/8 in. FNPT WCB; Single Stage Regulator; 0.073 in. port; 9-1/4 to 13 in. / 23 to 32 mbar; Vent over Outlet
912-101XA	1/4 x 3/8 in. FNPT WCB; Single Stage Regulator; 0.073 in. port; 9-1/4 to 13 in. / 23 to 32 mbar; Vent over Inlet

### Commercial/Industrial Low-Pressure Regulators (continued)

Type No.	Description
912-104	1/4 x 1/4 in. FNPT WCB; Single Stage Regulator; 0.073 in. port; 9-1/4 to 13 in. / 23 to 32 mbar; Vent over Outlet
912-112	1/4 x 3/8 in. FNPT; Single Stage Regulator; 0.073 in. port; 12 to 24 in. w.c. / 30 to 60 mbar; Vent over Outlet
912-122	1/4 x 3/8 in. FNPT WCB; Single Stage Regulator; with M318; 0.073 in. port; 9-1/4 to 13 in / 23 to 32 mbar; Vent over Outlet
912-197	1/4 x 3/8 in. FNPT Single Stage Regulator; 0.094 in. port; 12 to 24 in. w.c. / 30 to 60 mbar; Vent over Outlet
912-264	1/4 x 3/8 in. FNPT Single Stage Regulator; 0.073 in. port; 12 to 24 in. w.c. / 30 to 60 mbar; Vent over Outlet
912-264XA	1/4 x 3/8 in. FNPT Single Stage Regulator; 0.073 in. port; 12 to 24 in. w.c. / 30 to 60 mbar; Vent over Inlet
912-267	1/4 x 3/8 in. FNPT Single Stage Regulator; 0.073 in. port; 3 to 7 in. w.c. / 7.5 to 17 mbar; Vent over Outlet
912-569	1/4 x 3/8 in. FNPT; Regulator; port 13 1/2 in.; 10 to 1 psi / 0.7 to 0.07 bar
912H-108	1/4 x 3/8 in. FNPT High-Pressure Regulator; 0.094 in. port; 0.5 to 2.7 psi / 34 mbar to 0.19 bar; Vent over Outlet
912H-520	1/4 x 1/4 in. FNPT High-Pressure Regulator; 0.094 in. port; 2.7 to 5 psi / 0.19 to 0.34 bar; Vent over Outlet
912N-108B1	1/4 x 1/4 in. FNPT High Pressure Regulator; 0.094 in. port; 0.5 to 2.7 psi / 34 mbar to 0.19 bar; Vent over Outlet
912N-109	1/4 x 3/8 in. FNPT Single Stage Regulator; 0.073 in. port; 5 to 10 in. w.c. / 12 to 25 mbar; Vent over Outlet
912N-113	1/4 x 3/8 in. FNPT Single Stage Regulator; 0.073 in. port; 3 to 7 in. w.c. / 7.5 to 17 mbar; Vent over Outlet
912N-194	1/4 x 1/4 in. FNPT Single Stage Regulator; 0.073 in. port; 3 to 7 in. w.c. / 7.5 to 17 mbar; Vent over Outlet
99-501P	2 in. FNPT Cast Iron; High Pressure Reg; 1-1/8 in. port; 1/4 to 2 psig / 17 mbar to 0.14 bar; Max Pressure 150 psig / 10.3 bar
99-501PM	2 in. FNPT Cast Iron; High Pressure Monitor Regulator; 1-1/8 in. port; 1/4 to 2 psi / 17 mbar to 0.14 bar; Max Pressure 150 psig / 10.3 bar
99-502P	2 in. FNPT Cast Iron; High Pressure; 1-1/8 in. port; 1 to 5 psi / 69 mbar to 0.34 bar; Max Pressure 150 psig / 10.3 bar
99-502PM	2 in. FNPT Cast Iron; High Pressure Monitor Regulator; 1-1/8 in. port; 1 to 5 psi / 69 mbar to 0.34 bar; Max Pressure 150 psig / 10.3 bar
99-503P	2 in. FNPT Cast Iron; High Pressure; 1-1/8 in. port; 2 to 10 psi / 0.14 to 0.69 bar; Max Pressure 150 psig / 10.3 bar
99-503PM	2 in. FNPT Cast Iron; High Pressure Monitor Regulator; 1-1/8 in. port; 2 to 10 psi; Max Pressure 150 psig / 10.3 bar
99-504P	2 in. FNPT Cast Iron; High Pressure Regulator; 1-1/8 in. port; 5 to 15 psi / 0.34 to 1 bar; Max Pressure 150 psig / 10.3 bar
99-504PM	2 in. FNPT Cast Iron; High Pressure Regulator; 1-1/8 in. port; 5 to 15 psi / 0.34 to 1 bar; Max Pressure 150 psig / 10.3 bar
99-505P	2 in. FNPT Cast Iron; High Pressure Regulator; 1-1/8 in. port; 10 to 20 psi / 0.69 to 1.4 bar; Max Pressure 150 psig / 10.3 bar
99-505PM	2 in. FNPT Cast Iron; High Pressure Monitor Regulator; 1-1/8 in. port; 10 to 20 psi / 0.69 to 1.4 bar; Max Pressure 150 psig / 10.3 bar
CS200IR-6AC1	3/4 in. FNPT Cast Iron Low Pressure Regulator; 1/2 in. Port Internal/Relief 3.5 to 5 in. w.c. / 8.7 to 12 mbar
CS200IR-6AC3	1 in. FNPT Cast Iron Low Pressure Regulator; 1/2 in. Port Internal/Relief 3.5 to 5 in. w.c. / 8.7 to 12 mbar
CS200IR-6AC6	1-1/4 FNPT Cast Iron Low Pressure Regulator; 1/2 in. Port Internal/Relief 3.5 to 5 in. w.c. / 8.7 to 12 mbar
CS200IR-6BC1	3/4 in. FNPT Cast Iron Low Pressure Regulator; 1/2 in. Port Internal/Relief 4.5 to 6.5 in. w.c. / 11 to 16 mbar
CS200IR-6BC3	1 in. FNPT Cast Iron Low Pressure Regulator; 1/2 in. Port Internal/Relief 4.5 to 6.5 in. w.c. / 11 to 16 mbar
CS200IR-6BC6	1-1/4 in. FNPT Cast Iron Low Pressure Regulator; 1/2 in. Port Internal/Relief 4.5 to 6.5 in. w.c. / 11 to 16 mbar
CS200IR-6CC1	3/4 in. FNPT Cast Iron Low Pressure Regulator; 1/2 in. Port Internal/Relief 6 to 8 in. w.c. / 15 to 20 mbar
CS200IR-6CC3	1 in. FNPT Cast Iron Low Pressure Regulator; 1/2 in. Port Internal/Relief 6 to 8 in. w.c. / 15 to 20 mbar
CS200IR-6CC6	1-1/4 FNPT Cast Iron Low Pressure Regulator; 1/2 in. Port Internal/Relief 6 to 8 in. w.c. / 15 to 20 mbar

Type No.	Description
CS200IR-6DC1	3/4 in. FNPT Cast Iron Low Pressure Regulator; 1/2 in. Port Internal/Relief 7.5 to 11 in. w.c. / 19 to 27 mbar
CS200IR-6DC3	1 in. FNPT Cast Iron Low Pressure Regulator; 1/2 in. Port Internal/Relief 7.5 to 11 in. w.c. / 19 to 27 mbar
CS200IR-6DC6	1-1/4 FNPT Cast Iron Low Pressure Regulator; 1/2 in. Port Internal/Relief 7.5 to 11 in. w.c. / 19 to 27 mbar
CS200IR-6EC1	3/4 in. FNPT Cast Iron Low Pressure Regulator; 1/2 in. Port Internal/Relief 10 to 14 in. w.c. / 25 to 35 mbar
CS200IR-6EC3	1 in. FNPT Cast Iron Low Pressure Regulator; 1/2 in. Port Internal/Relief 10 to 14 in. w.c. / 25 to 35 mbar
CS200IR-6EC6	1-1/4 FNPT Cast Iron Low Pressure Regulator; 1/2 in. Port Internal/Relief 10 to 14 in. w.c. / 25 to 35 mbar
CS200IR-6FC1	3/4 in. FNPT Cast Iron Low Pressure Regulator; 1/2 in. Port Internal/Relief 12 to 19 in. w.c. / 30 to 47 mbar
CS200IR-6FC3	1 in. FNPT Cast Iron Low Pressure Regulator; 1/2 in. Port Internal/Relief 12 to 19 in. w.c. / 30 to 47 mbar
CS200IR-6FC6	1-1/4 FNPT Cast Iron Low Pressure Regulator; 1/2 in. Port Internal/Relief 12 to 19 in. w.c. / 30 to 47 mbar
CS200IR-6GC1	3/4 in. FNPT Cast Iron Low Pressure Regulator; 1/2 in. Port Internal/Relief 18 in. w.c. to 1 psig / 45 mbar to 69 bar
CS200IR-6GC3	1 in. FNPT Cast Iron Low Pressure Regulator; 1/2 in. Port Internal/Relief 18 in. w.c. to 1 psig / 45 mbar to 69 bar
CS200IR-6GC6	1-1/4 in. FNPT Cast Iron Low Pressure Regulator; 1/2 in. Port Internal/Relief 18 in. w.c. to 1 psig / 45 mbar to 69 bar
CS200IR-6HC1	3/4 in. FNPT Cast Iron Low Pressure Regulator; 1/2 in. Port Internal/Relief 1 to 2 psig / 69 mbar to 0.14 bar
CS200IR-6HC3	1 in. FNPT Cast Iron Low Pressure Regulator; 1/2 in. Port Internal/Relief 1 to 2 psig / 69 mbar to 0.14 bar
CS200IR-6HC6	1-1/4 in. FNPT Cast Iron Low Pressure Regulator; 1/2 in. Port Internal/Relief 1 to 2 psig / 69 mbar to 0.14 bar
CS205IR-4AC1	3/4 in. FNPT Cast Iron Low Pressure Regulator; Internal Relief; 5/16 in. Secondary Seat; Seal; 3.5 to 5 in. w.c. / 8.7 to 12 mbar
CS205IR-4AC3	1 in. FNPT Cast Iron Low Pressure Regulator; Internal Relief; 5/16 in. Secondary Seat; Seal; 3.5 to 5 in. w.c. / 8.7 to 12 mbar
CS205IR-4AC6	1-1/4 in. FNPT Cast Iron Low Pressure Regulator; Internal Relief; 5/16 in. Secondary Seat; Seal; 3.5 to 5 in. w.c. / 8.7 to 12 mbar
CS205IR-4BC1	3/4 in. FNPT Cast Iron Low Pressure Regulator; Internal Relief; 5/16 in. Secondary Seat; Seal; 4.5 to 6.5 in. w.c. / 11 to 16 mbar
CS205IR-4BC3	1 in. FNPT Cast Iron Low Pressure Regulator; Internal Relief; 5/16 in. Secondary Seat; Seal; 4.5 to 6.5 in. w.c. / 11 to 16 mbar
CS205IR-4BC6	1-1/4 in. FNPT Cast Iron Low Pressure Regulator; Internal Relief; 5/16 in. Secondary Seat; Seal; 4.5 to 6.5 in. w.c. / 11 to 16 mbar
CS205IR-4CC1	3/4 in. FNPT Cast Iron Low Pressure Regulator; Internal Relief; 5/16 in. Secondary Seat; Seal; 6 to 8 in. w.c. / 15 to 20 mbar
CS205IR-4CC3	1 in. FNPT Cast Iron Low Pressure Regulator; Internal Relief; 5/16 in. Secondary Seat; Seal; 6 to 8 in. w.c. / 15 to 20 mbar
CS205IR-4CC6	1-1/4 in. FNPT Cast Iron Low Pressure Regulator; Internal Relief; 5/16 in. Secondary Seat; Seal; 6 to 8 in. w.c. / 15 to 20 mbar
CS205IR-4DC1	3/4 in. FNPT Cast Iron Low Pressure Regulator; Internal Relief; 5/16 in. Secondary Seat; Seal; 7.5 to 11 in. w.c. / 19 to 27 mbar
CS205IR-4DC3	1 in. FNPT Cast Iron Low Pressure Regulator; Internal Relief; 5/16 in. Secondary Seat; Seal; 7.5 to 11 in. w.c. / 19 to 27 mbar
CS205IR-4DC6	1-1/4 in. FNPT Cast Iron Low Pressure Regulator; Internal Relief; 5/16 in. Secondary Seat; Seal; 7.5 to 11 in. w.c. / 19 to 27 mbar
CS205IR-4EC1	3/4 in. FNPT Cast Iron Low Pressure Regulator; Internal Relief; 5/16 in. Secondary Seat; Seal; 10 to 14 in. w.c. / 25 to 35 mbar
CS205IR-4EC3	1 in. FNPT Cast Iron Low Pressure Regulator; Internal Relief; 5/16 in. Secondary Seat; Seal; 10 to 14 in. w.c. / 25 to 35 mbar
CS205IR-4EC6	1-1/4 in. FNPT Cast Iron Low Pressure Regulator; Internal Relief; 5/16 in. Secondary Seat; Seal; 10 to 14 in. w.c. / 25 to 35 mbar
CS205IR-4FC1	3/4 in. FNPT Cast Iron Low Pressure Regulator; Internal Relief; 5/16 in. Secondary Seat; Seal; 12 to 19 in. w.c. / 30 to 47 mbar
CS205IR-4FC3	1 in. FNPT Cast Iron Low Pressure Regulator; Internal Relief; 5/16 in. Secondary Seat; Seal; 12 to 19 in. w.c. / 30 to 47 mbar
CS205IR-4FC6	1-1/4 in. FNPT Cast Iron Low Pressure Regulator; Internal Relief; 5/16 in. Secondary Seat; Seal; 12 to 19 in. w.c. / 30 to 47 mbar







## Commercial/Industrial Low-Pressure Regulators (continued)

Type No.	Description
CS800IR-8DC7	1-1/2 in. FNPT Cast Iron; Low Pressure Regulator; with Relief; 1 in. Port; 10 to 16 in. w.c. / 25 to 40 mbar
CS800IR-8DC8	2 in. FNPT Cast Iron; Low Pressure Regulator; with Relief; 1 in. Port; 10 to 16 in. w.c. / 25 to 40 mbar
CS800IR-8EC7	1-1/2 in. FNPT Cast Iron; Low Pressure Regulator; with Relief; 1 in. Port; 14 to 30 in. w.c. / 35 to 75 mbar
CS800IR-8EC8	2 in. FNPT Cast Iron; Low Pressure Regulator; with Relief; 1 in. Port; 14 to 30 in. w.c. / 35 to 75 mbar
CS820IQ-8FC7	1-1/2 in. FNPT Cast Iron; Low Pressure Regulator; with High Capacity Internal; 1 in. Port; 1 to 2.5 psig / 69 mbar to 0.17 bar
CS820IQ-8FC8	2 in. FNPT Cast Iron; Low Pressure Regulator; with High Capacity Internal; 1 in. Port; 1 to 2.5 psig / 69 mbar to 0.17 bar
CS820IQ-8GC7	1-1/2 in. FNPT Cast Iron; Low Pressure Regulator; with High Capacity Internal; 1 in. Port; 1.5 to 3.5 psig / 0.1 to 0.24 bar
CS820IQ-8GC8	2 in. FNPT Cast Iron; Low Pressure Regulator; with High Capacity Internal; 1 in. Port; 1.5 to 3.5 psig / 0.1 to 0.24 bar
CS820IQ-8HC7	1-1/2 in. FNPT Cast Iron; Low Pressure Regulator; with High Capacity Internal; 1 in. Port; 2.5 to 5.5 psig / 0.17 to 0.38 bar
CS820IQ-8HC8	2 in. FNPT Cast Iron; Low Pressure Regulator; with High Capacity Internal; 1 in. Port; 2.5 to 5.5 psig / 0.17 to 0.38 bar
CS820IR-8FC7	1-1/2 in. FNPT Cast Iron; Low Pressure Regulator; with Relief; 1 in. Port; 1 to 2.5 psig / 69 mbar to 0.17 bar
CS820IR-8FC8	2 in. FNPT Cast Iron; Low Pressure Regulator; with Relief; 1 in. Port; 1 to 2.5 psig / 69 mbar to 0.17 bar
CS820IR-8GC7	1-1/2 in. FNPT Cast Iron; Low Pressure Regulator; with Relief; 1 in. Port; 1.5 to 3.5 psig / 0.1 to 0.24 bar
CS820IR-8GC8	2 in. FNPT Cast Iron; Low Pressure Regulator; with Relief; 1 in. Port; 1.5 to 3.5 psig / 0.1 to 0.24 bar
CS820IR-8HC7	1-1/2 in. FNPT Cast Iron; Low Pressure Regulator; with Relief; 1 in. Port; 2.5 to 5.5 psig / 0.17 to 0.38 bar
CS820IR-8HC8	2 in. FNPT Cast Iron; Low Pressure Regulator; with Relief; 1 in. Port; 2.5 to 5.5 psig / 0.17 to 0.38 bar

## Residential Regulators - 1st Stage

Type No.	Description
R122H-AAJ	1st Stage Compact Regulator; 1/4 x 1/2 in. NPT; Non-Adjustable
R122H-AAJXB	1st Stage Compact Regulator; 1/4 x 1/2 in. NPT; Non-Adjustable; Vent over Tap
R222H-BGJ	1st Stage Compact Regulator; 1/2 x 1/2 in. NPT; 8 to 12 psig / 0.55 to 0.83 bar Spring
R222H-BGK	1st Stage Compact Regulator; 1/2 x 1/2 in. NPT; 4 to 6 psig / 0.28 to 0.41 bar Spring
R222H-DGJ	1st Stage Compact Regulator; 3/4 x 3/4 in. NPT; 8 to 12 psig / 0.55 to 0.83 bar Spring
R222H-DGK	1st Stage Compact Regulator; 3/4 x 3/4 in. NPT; 4 to 6 psig / 0.28 to 0.41 bar Spring
R222H-HGJ	1st Stage Compact Regulator; POL x 1/2 in. NPT; 8 to 12 psig / 0.55 to 0.83 bar Spring
R222H-HGK	1st Stage Compact Regulator; POL x 1/2 in. NPT; 4 to 6 psig / 0.28 to 0.41 bar Spring
R222H-JGJ	1st Stage Compact Regulator; POL x 3/4 in. NPT; 8 to 12 psig / 0.55 to 0.83 bar Spring
R222H-JGK	1st Stage Compact Regulator; POL x 3/4 in. NPT; 4 to 6 psig / 0.28 to 0.41 bar Spring
R622H-BGJ	1st Stage Regulator; 1/2 x 1/2 in. NPT; 8 to 12 psig / 0.55 to 0.83 bar Spring
R622H-BGK	1st Stage Regulator; 1/2 x 1/2 in. NPT; 4 to 6 psig / 0.28 to 0.41 bar Spring
R622H-DGJ	1st Stage Regulator; 3/4 x 3/4 in. NPT; 8 to 12 psig / 0.55 to 0.83 bar Spring
R622H-DGK	1st Stage Regulator; 3/4 x 3/4 in. NPT; 4 to 6 psig / 0.28 to 0.41 bar Spring

## Residential Regulators - 1st Stage (continued)

Type No.	Description
R622H-HGJ	1st Stage Regulator; POL x 1/2 in. NPT; 8 to 12 psig / 0.55 to 0.83 bar Spring
R622H-HGK	1st Stage Regulator; POL x 1/2 in. NPT; 4 to 6 psig / 0.28 to 0.41 bar Spring
R622H-JGJ	1st Stage Regulator; POL x 3/4 in. NPT; 8 to 12 psig / 0.55 to 0.83 bar Spring
R622H-JGK	1st Stage Regulator; POL x 3/4 in. NPT; 4 to 6 psig / 0.28 to 0.41 bar Spring

## Residential Regulators - 2nd Stage

Type No.	Description
HSRL-BFC	3/4 in. FNPT CI, 2nd Stage UL Reg w/Relief, 3/8 in. port, 10 to 12.5 in. w.c. / 25 to 31 mbar, 3/4 in. Vent
HSRL-CFC	1 in. FNPT CI, 2nd Stage UL Reg w/Relief, 3/8 in. port, 10 to 12.5 in. w.c. / 25 to 31 mbar, 3/4 in. Vent
HSRL-PFC	3/4 in. FNPT Cast Iron Angle ~ 2nd Stage UL® Regulator with Relief; 3/8 in. Port; 9 to 13 in. w.c. / 22 to 32 mbar
HSRL-SFC	1 in. FNPT Cast Iron Angle ~ 2nd Stage UL Regulator with Relief; 3/8 in. Port; 9 to 13 in. w.c. / 22 to 32 mbar
HSR-BBCALYN	3/4 in. FNPT Regulator with Relief, 1/8 in orifice, 10 to 12.5 in. w.c. / 25 to 31 mbar; 3/4 in. vent
HSR-BBGBMYN	3/4 in. FNPT Regulator with Relief, 1/8 in. orifice, 12.5 to 20 in. w.c. / 31 to 50 mbar; 1 in. vent
HSR-BCBBMYN	3/4 in. FNPT Regulator with Relief, 3/16 in. orifice, 6 to 8 in. w.c. / 15 to 20 mbar; 1 in. vent
HSR-BDCAMYN	3/4 in. FNPT Regulator with Relief, 1/4 in. orifice, 10 to 12.5 in. w.c. / 25 to 31 mbar; 3/4 in. vent
HSR-BFCAMYN	3/4 in. FNPT Regulator with Relief, 3/8 in. orifice, 10 to 12.5 in. w.c. / 25 to 31 mbar; 3/4 in. vent
HSR-BFGAMYN	3/4 in. FNPT Regulator with Relief, 3/8 in. orifice, 12.5 to 20 in. w.c. / 31 to 50 mbar, 3/4 in. vent
HSR-BFJAMYN	3/4 in. FNPT Regulator with Relief, 3/8 in. orifice, 1.25 to 2.2 psig / 86 mbar to 0.15 bar, 3/4 in. vent
HSR-BFJBMYN	3/4 in. FNPT Regulator with Relief, 3/8 in. orifice, 1.25 to 2.2 psig / 86 mbar to 0.15 bar, 1 in. vent
HSR-CBBAMYN	1 in. FNPT Regulator with Relief, 1/8 in. orifice, 6 to 8 in. w.c. / 15 to 20 mbar; 3/4 in. vent
HSR-CCCBMYN	1 in. FNPT Regulator with Relief, 3/16 in. orifice, 10 to 12.5 in. w.c. / 25 to 31 mbar; 1 in. vent
HSR-CDCBMYN	1 in. FNPT Regulator with Relief, 1/4 in. orifice, 10 to 12.5 in. w.c. / 25 to 31 mbar; 1 in. vent
HSR-CDGAMYN	1 in. FNPT Regulator with Relief, 1/4 in. orifice, 12.5 to 20 in. w.c. / 31 to 50 mbar; 3/4 in. vent
HSR-CDGBMYN	1 in. FNPT Regulator with Relief, 1/4 in. orifice, 12.5 to 20 in. w.c. / 31 to 50 mbar; 1 in. vent
HSR-CFCALYN	1 in. FNPT Regulator with Relief, 3/8 in. orifice, 10 to 12.5 in. w.c. / 25 to 31 mbar; 3/4 in. vent, 3E position
HSR-CFCAMYN	1 in. FNPT Regulator with Relief, 3/8 in. orifice, 10 to 12.5 in. w.c. / 25 to 31 mbar; 3/4 in. vent
HSR-CFGAMYN	1 in. FNPT Regulator with Relief, 3/8 in. orifice, 12.5 to 20 in. w.c. / 31 to 50 mbar; 3/4 in. vent
HSR-CFGBMYN	1 in. FNPT Regulator with Relief, 3/8 in. orifice, 12.5 to 20 in. w.c. / 31 to 50 mbar; 1 in. vent
HSR-CFJAMYN	1 in. FNPT Regulator with Relief, 3/8 in. orifice, 1.25 to 2.2 psig / 86 mbar to 0.15 bar, 3/4 in. vent
HSR-CFJBMYN	1 in. FNPT Regulator with Relief, 3/8 in. orifice, 1.25 to 2.2 psig / 86 mbar to 0.15 bar, 1 in. vent
HSR-CHBAMYN	1 in. FNPT Regulator with Relief, 1/2 in. orifice, 6 to 8 in. w.c. / 15 to 20 mbar; 3/4 in. vent
HSR-CHCALYN	1 in. FNPT Regulator with Relief, 1/2 in. orifice, 10 to 12.5 in. w.c. / 25 to 31 mbar; 3/4 in. vent, 3E position
HSR-CHCBMYN	1 in. FNPT Regulator with Relief, 1/2 in. orifice, 10 to 12.5 in. w.c. / 25 to 31 mbar; 1 in. vent

## Residential Regulators - 2nd Stage (continued)

Type No.	Description
HSR-CHGBMYN	1 in. FNPT Regulator with Relief, 1/2 in. orifice, 12.5 to 20 in. w.c. / 31 to 50 mbar; 1 in. vent
HSR-CHHALYN	1 in. FNPT Regulator with Relief, 1/2 in. orifice, 20 to 35 in. w.c. / 50 to 87 mbar; 3/4 in. vent, 3E position
HSR-CHJBYN	1 in. FNPT Regulator with Relief, 1/2 in. orifice, 1.25 to 2.2 psig / 86 mbar to 0.15 bar, 1 in. vent
HSR-PFCAMYN	3/4 in. FNPT Cast Iron Angle, Low Pressure Regulator with Relief, 3/8 in. port, 10 to 12.5 in. w.c. / 25 to 31 mbar, 3/4 in. Vent
HSR-SFCAMYN	1 in. FNPT Cast Iron Angle, Low Pressure Regulator with Relief, 3/8 in. port, 10 to 12.5 in. w.c. / 25 to 31 mbar, 3/4 in. Vent
R222-BAF	2nd Stage Compact Regulator; 1/2 x 1/2 in. NPT; 9.5 to 13 in. w.c. Spring
R222-BAFXA	2nd Stage Compact Regulator; 1/2 x 1/2 in NPT; 9.5 to 13 in. w.c. / 24 to 32 mbar Spring; Vent over Outlet
R622-BCC	2nd Stage Regulator; 1/2 x 1/2 in. NPT; 8 to 10 in. w.c. / 20 to 25 mbar Spring
R622-BCF	2nd Stage Regulator; 1/2 x 1/2 in. NPT; 9 to 13 in. w.c. / 22 to 32 mbar Spring
R622-BCFXA	2nd Stage Regulator; 1/2 x 1/2 in. NPT; 9 to 13 in. w.c. / 22 to 32 mbar Spring; Vent over Outlet
R622-BCG	2nd Stage Regulator; 1/2 x 1/2 in. NPT; 13 to 20 in. w.c. / 32 to 50 mbar Spring
R622-BCMxB	2nd Stage Regulator; 1/2 x 1/2 in. NPT; 20 to 35 in. w.c. / 50 to 87 mbar Spring
R622-CFF	2nd Stage Regulator; 1/2 x 3/4 in. NPT; 9 to 13 in. w.c. / 22 to 32 mbar Spring
R622-CFFXA	2nd Stage Regulator; 1/2 x 3/4 inch NPT; 9 to 13 in. w.c. / 22 to 32 mbar Spring; Vent over Outlet
R622-CFFXB	2nd Stage Regulator; 1/2 x 3/4 in. NPT; 9 to 13 in. w.c. / 22 to 32 mbar Spring; Vent Opposite Taps
R622-CFG	2nd Stage Regulator; 1/2 x 3/4 in. NPT; 13 to 20 in. w.c. / 32 to 50 mbar Spring
R622-CFGXA	2nd Stage Regulator; 1/2 x 3/4 in. NPT; 13 to 20 in. w.c. / 32 to 50 mbar Spring; Vent over Inlet
R622-DFF	2nd Stage Regulator; 3/4 x 3/4 in. NPT; 9 to 13 in. w.c. / 22 to 32 mbar Spring
R622-DFFXB	2nd Stage Regulator; 3/4 x 3/4 in. NPT; 9 to 13 in. w.c. / 22 to 32 mbar Spring; Vent over Outlet
R622-DFG	2nd Stage Regulator; 3/4 x 3/4 in. NPT; 13 to 20 in. w.c. / 32 to 50 mbar Spring
R642-DFF	2nd Stage Regulator; Side Outlet; 3/4 x 3/4 in. NPT; 9 to 13 in. w.c. / 22 to 32 mbar Spring
R642-DFFXA	2nd Stage Regulator; Side Outlet; 3/4 x 3/4 in. NPT; 9 to 13 in. w.c. / 22 to 32 mbar Spring; Vent over Outlet
R652-CFF	2nd Stage Regulator; Backmount; 1/2 x 3/4 in. NPT; 9 to 13 in. w.c. / 22 to 32 mbar Spring
R652-DFF	2nd Stage Regulator; Backmount; 3/4 x 3/4 in. NPT; 9 to 13 in. w.c. / 22 to 32 mbar Spring

## Residential Regulators - 2 psi / 0.14 bar Outlet

Type No.	Description
R622E-BCH	2nd Stage Regulator; 1/2 x 1/2 in. NPT; 1 to 2.2 psig / 69 mbar to 0.15 bar Spring
R622E-DCH	2nd Stage Regulator; 3/4 x 3/4 in. NPT; 1 to 2.2 psig / 69 mbar to 0.15 bar Spring
R652E-DFH	2nd Stage Regulator; Backmount; 3/4 x 3/4 in. NPT; 1 to 2.2 psig / 69 mbar to 0.15 bar Spring

## Residential Regulators - Integral Two-Stage

Type No.	Description
R232A-BBF	Compact Integral 2nd Stage Regulator; 1/4 x 1/2 in. NPT; 9.5 to 13 in. w.c. / 24 to 32 mbar Spring
R232A-BBFXA	Compact Integral 2nd Stage Regulator; 1/4 x 1/2 in. NPT; 9.5 to 13 in. w.c. / 24 to 32 mbar Spring; Vent Opposite Tap
R232A-HBF	Compact Integral 2nd Stage Regulator; POL x 1/2 in. NPT; 9.5 to 13 in. w.c. / 24 to 32 mbar Spring
R232A-HBFXA	Compact Integral 2nd Stage Regulator; POL x 1/2 in. NPT; 9.5 to 13 in. w.c. / 24 to 32 mbar Spring; Vent Opposite Tap
R632A-BCF	Integral 2nd Stage Regulator; 1/4 x 1/2 in. NPT; 9 to 13 in. w.c. / 24 to 32 mbar Spring
R632A-BCFXA	Integral 2nd Stage Regulator; 1/4 x 1/2 in. NPT; 9 to 13 in. w.c. / 24 to 32 mbar Spring; Vent Opposite Taps
R632A-BCG	Integral 2nd Stage Regulator; 1/4 x 1/2 in. NPT; 13 to 20 in. w.c. / 32 to 50 mbar Spring
R632A-CFF	Integral 2nd Stage Regulator; 1/4 x 3/4 in. NPT; 9 to 13 in. w.c. / 22 to 32 mbar Spring
R632A-CFFXA	Integral 2nd Stage Regulator; 1/4 x 3/4 in. NPT; 9 to 13 in. w.c. / 22 to 32 mbar Spring; Vent Opposite Taps
R632A-CFG	Integral 2nd Stage Regulator; 1/4 x 3/4 in. NPT; 13 to 20 in. w.c. / 32 to 50 mbar Spring
R632A-HCF	Integral 2nd Stage Regulator; POL x 1/2 in. NPT; 9 to 13 in. w.c. / 22 to 32 mbar Spring
R632A-HCFXA	Integral 2nd Stage Regulator; POL x 1/2 in. NPT; 9 to 13 in. w.c. / 22 to 32 mbar Spring; Vent Opposite Taps
R632A-JFF	Integral 2nd Stage Regulator; POL x 3/4 in. NPT; 9 to 13 in. w.c. / 22 to 32 mbar Spring
R632A-JFFXA	Integral 2nd Stage Regulator; POL x 3/4 in. NPT; 9 to 13 in. w.c. / 22 to 32 mbar Spring; Vent Opposite Taps

## Residential Regulators - Integral Two-Stage, 2 psi / 0.14 bar Outlet

Type No.	Description
R232E-BBH	Compact Integral 2nd Stage Regulator; 1/4 x 1/2 in. NPT; 1 to 2.2 psig / 69 mbar to 0.15 bar Spring
R232E-BBHXA	Compact Integral 2nd Stage Regulator; 1/4 x 1/2 in. NPT; 1 to 2.2 psig / 69 mbar to 0.15 bar Spring; Vent Opposite Tap
R232E-HBH	Compact Integral 2nd Stage Regulator; POL x 1/2 in. NPT; 1 to 2.2 psig / 69 mbar to 0.15 bar Spring
R232E-HBHXA	Compact Integral 2nd Stage Regulator, Pol X 1/2 in. NPT, 1 to 2.2 psig / 69 mbar to 0.15 bar Spring, Vent Opposite Tap
R632E-BCH	Integral 2nd Stage Regulator; 1/4 x 1/2 in. NPT; 1 to 2.2 psig / 69 mbar to 0.15 bar Spring
R632E-BCHXA	Integral 2nd Stage Regulator; 1/4 x 1/2 in. NPT; 1 to 2.2 psig / 69 mbar to 0.15 bar Spring; Vent Opposite Taps
R632E-CFH	Integral 2nd Stage Regulator; 1/4 x 3/4 in. NPT; 1 to 2.2 psig / 69 mbar to 0.15 bar Spring
R632E-CFHXA	Integral 2nd Stage Regulator; 1/4 x 3/4 in. NPT; 1 to 2.2 psig / 69 mbar to 0.15 bar Spring; Vent Opposite Taps
R632E-HCH	Integral 2nd Stage Regulator; POL x 1/2 in. NPT; 1 to 2.2 psig / 69 mbar to 0.15 bar Spring
R632E-HCHXA	Integral 2nd Stage Regulator; POL x 1/2 in. NPT; 1 to 2.2 psig / 69 mbar to 0.15 bar Spring; Vent Opposite Taps
R632E-JFH	Integral 2nd Stage Regulator; POL x 3/4 in. NPT; 1 to 2.2 psig / 69 mbar to 0.15 bar Spring
R632E-JFHXA	Integral 2nd Stage Regulator; POL x 3/4 in. NPT; 1 to 2.2 psig / 69 mbar to 0.15 bar Spring; Vent Opposite Taps

## Backpressure Regulators/Relief

Type No.	Description
1805-15	3/4 in. FNPT Cast Iron; Relief Valve with Brass cap; 5 to 35 psi / 0.34 to 2.4 bar
1805-16	3/4 in. FNPT Cast Iron; Relief Valve with Brass cap; 10 to 60 psi / 0.69 to 4.1 bar
1805-17	3/4 in. FNPT Cast Iron; Relief Valve with Brass cap; 20 to 125 psi / 1.4 to 8.6 bar
1805-18P	1 in. FNPT Cast Iron; Relief Valve with Brass cap; 5 to 35 psi / 0.34 to 2.4 bar
1805-19P	1 in. FNPT Cast Iron; Relief Valve with Brass cap; 10 to 60 psi / 0.69 to 4.1 bar
1805-20	1 in. FNPT Cast Iron; Relief Valve with Brass cap; 20 to 125 psi / 1.4 to 8.6 bar
1805-31	1-1/2 in. FNPT Cast Iron; Relief Valve with Brass cap; 5 to 20 psi / 0.34 to 1.4 bar
1805-32	1-1/2 in. FNPT Cast Iron; Relief Valve with Brass cap; 10 to 50 psi / 0.69 to 3.4 bar
1805-33	1-1/2 in. FNPT Cast Iron; Relief Valve with Brass cap; 35 to 125 psi / 2.4 to 8.6 bar
1805-34	3/4 in. FNPT Cast Iron; Relief Valve; 5 to 35 psi / 0.34 to 2.4 bar
1805-51P	2 in. FNPT Cast Iron; Relief Valve with Brass cap; 5 to 20 psi / 0.34 to 1.4 bar
1805-52P	2 in. FNPT Cast Iron; Relief Valve with Brass cap; 10 to 50 psi / 0.69 to 3.4 bar
1805-53	2 in. FNPT Cast Iron; Relief Valve with Brass cap; 35 to 125 psi / 2.4 to 8.6 bar
1808-40	2 in. FNPT Cast Iron; Back Pressure/Relief Valve; 3 to 18 psi / 0.21 to 1.2 bar; Type 6358 Pilot
1808-50	2 in. FNPT Cast Iron; Back Pressure/Relief Valve; 3 to 18 psi / 0.21 to 1.2 bar; Type 6358B Pilot
1808-51	2 in. FNPT Cast Iron; Back Pressure/Relief Valve; 15 to 40 psi / 1 to 2.8 bar; Type 6358B Pilot
1808-52	2 in. FNPT Cast Iron; Back Pressure/Relief Valve; 35 to 125 psi / 2.4 to 8.6 bar; Type 6358B Pilot
1808A-60	2 in. FNPT Cast Iron; Back Pressure/ Relief Valve; Angle body; 3 to 18 psi / 0.21 to 1.2 bar; Type 6358B Pilot
1808A-61	2 in. FNPT Cast Iron; Back Pressure/ Relief Valve; Angle body; 15 to 40 psi / 1 to 2.8 bar; Type 6358B Pilot
1808A-62	2 in. FNPT Cast Iron; Back Pressure/ Relief Valve; Angle body; 35 to 125 psi / 2.4 to 8.6 bar; Type 6358B Pilot
289A-1	1/4 in. FNPT Zinc-plated Carbon; Relief Valve; 3 to 13 psi / 0.21 to 0.9 bar
289A-2	1/4 in. FNPT Zinc-plated Carbon; Relief Valve; 11 to 22 psi / 0.76 to 1.5 bar
289H-1	2 in. FNPT Cast Iron; Relief Valve; 7 to 18 in. w.c. / 17 to 45 mbar
289H-2	2 in. FNPT Cast Iron; Relief Valve; 1/2 to 2-1/4 psi / 34 mbar to 0.16 bar
289H-3	2 in. FNPT Cast Iron; Relief Valve; 1-3/4 to 7 psi / 0.12 to 0.48 bar
289H-4	2 in. FNPT Cast Iron; Relief Valve; 4 to 10 psi / 0.28 to 0.69 bar
289H-41	1 in. FNPT Aluminum; Relief Valve; 1 to 4-1/2 psi / 69 mbar to 0.31 bar
289H-42	1 in. FNPT Aluminum; Relief Valve; 4 to 15 psi / 0.28 to 1 bar
289H-43	1 in. FNPT Aluminum; Relief Valve; 10 to 20 psi / 0.69 to 1.4 bar
289H-49	1 in. FNPT Aluminum; Relief Valve; 15 to 50 psi / 1 to 3.4 bar
289H-49V	1 in. FNPT Aluminum; Relief Valve; 15 to 50 psi / 1 to 3.4 bar with Fluorocarbon (FKM) and Brass Trim
289HH-1	1 in. FNPT Aluminum; Relief Valve; 45 to 75 psi / 3.1 to 5.2 bar
289L-21	1 in. FNPT Aluminum; Relief Valve; 12 to 40 in. w.c. / 30 to 100 mbar

Type No.	Description
289L-22	1 in. FNPT Aluminum; Relief Valve; 10 to 18 in. w.c. / 25 to 45 mbar
289L-24	3/4 in. FNPT Aluminum; Relief Valve; 10 to 18 in. w.c. / 25 to 45 mbar
289L-26	3/4 in. FNPT Aluminum; Relief Valve; 12 to 40 in. w.c. / 30 to 100 mbar
630R-13	2 in. FNPT Cast Iron, Relief Valve, 20 to 35 psi / 1.4 to 2.4 bar
MR98H-100	2 in. FNPT Cast Iron, Relief Valve/Backpressure Regulator, 50 to 100 psig / 3.4 to 6.9 bar, Trim 6
MR98H-108	1-1/2 in. FNPT Cast Iron, Relief Valve/Backpressure Regulator, 80 to 170 psig / 5.5 to 11.7 bar, Trim 6
MR98H-109	1-1/2 in. FNPT Cast Iron, Relief Valve/Backpressure Regulator, 80 to 170 psig / 5.5 to 11.7 bar, Trim 1
MR98H-112	2 in. FNPT Cast Iron, Relief Valve/Backpressure Regulator, 75 to 170 psig / 5.2 to 11.7 bar, Trim 6
MR98H-13	1/2 in. FNPT Cast Iron, Relief Valve/Backpressure Regulator, 25 to 75 psig / 1.7 to 5.2 bar, Trim 6
MR98H-14	1/2 in. FNPT Cast Iron, Relief Valve/Backpressure Regulator, 70 to 140 psig / 4.8 to 9.7 bar, Trim 6
MR98H-15	1/2 in. FNPT Cast Iron, Relief Valve/Backpressure Regulator, 130 to 200 psig / 9 to 13.8 bar, Trim 6
MR98H-17	1/2 in. FNPT Cast Iron, Relief Valve/Backpressure Regulator, 25 to 75 psig / 1.7 to 5.2 bar, Trim 1
MR98H-18	1/2 in. FNPT Cast Iron, Relief Valve/Backpressure Regulator, 70 to 140 psig / 4.8 to 9.7 bar, Trim 1
MR98H-20	3/4 in. FNPT Cast Iron, Relief Valve/Backpressure Regulator, 15 to 35 psig / 1 to 2.4 bar, Trim 6
MR98H-21	3/4 in. FNPT Cast Iron, Relief Valve/Backpressure Regulator, 25 to 75 psig / 1.7 to 5.2 bar, Trim 6
MR98H-22	3/4 in. FNPT Cast Iron, Relief Valve/Backpressure Regulator, 70 to 140 psig / 4.8 to 9.7 bar, Trim 6
MR98H-25	3/4 in. FNPT Cast Iron, Relief Valve/Backpressure Regulator, 25 to 75 psig / 1.7 to 5.2 bar, Trim 1
MR98H-29	1 in. FNPT Cast Iron, Relief Valve/Backpressure Regulator, 25 to 75 psig / 1.7 to 5.2 bar, Trim 6
MR98H-30	1 in. FNPT Cast Iron, Relief Valve/Backpressure Regulator, 70 to 140 psig / 4.8 to 9.7 bar, Trim 6
MR98H-31	1 in. FNPT Cast Iron, Relief Valve/Backpressure Regulator, 130 to 200 psig / 9 to 13.8 bar, Trim 6
MR98H-34	1 in. FNPT Cast Iron, Relief Valve/Backpressure Regulator, 70 to 140 psig / 4.8 to 9.7 bar, Trim 1
MR98H-35	1 in. FNPT Cast Iron, Relief Valve/Backpressure Regulator, 130 to 200 psig / 9 to 13.8 bar, Trim 1
MR98H-63	1 in. FNPT WCC, Relief Valve/Backpressure Regulator, 130 to 200 psig / 9 to 13.8 bar, Trim 6
MR98H-65	1 in. FNPT WCC, Relief Valve/Backpressure Regulator, 25 to 75 psig / 1.7 to 5.2 bar, Trim 1
MR98H-77	2 in. FNPT Cast Iron, Relief Valve/Backpressure Regulator, 5 to 35 psig / 0.34 to 2.4 bar, Trim 1
MR98H-84	1-1/2 in. FNPT Cast Iron, Relief Valve/Backpressure Regulator, 20 to 65 psig / 1.4 to 4.5 bar, Trim 6
MR98H-91	2 in. FNPT WCC, Relief Valve/Backpressure Regulator, 20 to 65 psig / 1.4 to 4.5 bar, Trim 1
MR98H-97	1-1/2 in. FNPT Cast Iron, Relief Valve/Backpressure Regulator, 50 to 100 psig / 3.4 to 6.9 bar, Trim 1
MR98HH-12	1/2 in. FNPT WCC, High Pressure Relief Valve, 150 to 375 psig / 10.3 to 25.9 bar, Trim 1
MR98HH-15	3/4 in. FNPT WCC, High Pressure Relief Valve, 150 to 375 psig / 10.3 to 25.9 bar, Trim 6
MR98HH-19	1 in. FNPT WCC, High Pressure Relief Valve, 150 to 375 psig / 10.3 to 25.9 bar, Trim 6
MR98HH-20	1 in. FNPT WCC, High Pressure Relief Valve, 150 to 375 psig / 10.3 to 25.9 bar, Trim 1

### BS&T - Relief Valves

Type No.	Description
63EGLP-250	4 in. CL300 RF Flange; UL® Listed Multipilot Relief; 250 psig / 17.2 bar
63EGLP-EB1	4 in. CL300 RF Flange; Multipilot Relief; 85 to 140 psig / 5.9 to 9.7 bar
63EGLP-EB2	4 in. CL300 RF Flange; Multipilot Relief; 130 to 200 psig / 9 to 13.8 bar
63EGLP-EB3	4 in. CL300 RF Flange; Multipilot Relief; 180 to 350 psig / 12.4 to 24.1 bar
63EGLP-EBH	4 in. CL300 RF Flange; Multipilot Relief; 250 to 375 psig / 17.2 to 25.9 bar
H110-250	1/4 in. NPT Relief Valve; UL Listed; 250 psig / 17.2 bar setpoint
H110-312	1/4 in. NPT Relief Valve; UL Listed; 312 psig / 21.5 bar setpoint
H120-120	1/4 in. NPT Relief Valve; 120 psig / 8.3 bar setpoint
H120-145	1/4 in. NPT Relief Valve; 145 psig / 10 bar setpoint
H120-275	1/4 in. NPT Relief Valve; 275 psig / 19 bar setpoint
H120-30	1/4 in. NPT Relief Valve; 30 psig / 2.1 bar setpoint
H120-40	1/4 in. NPT Relief Valve; 40 psig / 2.8 bar setpoint
H120-60	1/4 in. NPT Relief Valve; 60 psig / 4.1 bar setpoint
H123	1/4 in. NPT Hydrostatic Relief Valve; UL Listed; 375 psig / 25.9 bar setpoint
H124	1/4 in. NPT Hydrostatic Relief Valve; UL Listed; 450 psig / 31 bar setpoint
H125-250	1/2 in. NPT Relief Valve; 250 psig / 17.2 bar setpoint
H135-312	1/2 in. NPT Relief Valve; 312 psig / 21.5 bar setpoint
H144	1/2 in. NPT Hydrostatic Relief Valve; UL Listed; 450 psig / 31 bar setpoint
H148	1/2 in. NPT Hydrostatic Relief Valve; UL Listed; 375 psig / 25.9 bar setpoint
H150-250	3/4 in. NPT Relief Valve; 250 psig / 17.2 bar setpoint
H160-312	3/4 in. NPT Relief Valve; 312 psig / 21.5 bar setpoint
H173	3/4 in. NPT Hydrostatic Relief Valve; UL Listed; 375 psig / 25.9 bar setpoint
H174	3/4 in. NPT Hydrostatic Relief Valve; UL Listed; 450 psig / 31 bar setpoint
H185-250	3/4 in. NPT Relief Valve; UL Listed; 250 psig / 17.2 bar setpoint
H185-275	3/4 in. NPT Relief Valve; UL Listed; 275 psig / 19 bar setpoint
H185-312	3/4 in. NPT Relief Valve; UL Listed; 312 psig / 21.5 bar setpoint
H284-125	3 x 2 in. NPT Brass Relief Valve; Set at 125 psig / 8.6 bar
H284-156	3 x 2 in. NPT Brass Relief Valve; Set at 156 psig / 10.8 bar
H284-225	3 x 2 in. NPT Brass Relief Valve; Set at 225 psig / 15.5 bar
H284-250	3 x 2 in. NPT Brass Relief Valve; Set at 250 psig / 17.2 bar
H284-275	3 x 2 in. NPT Brass Relief Valve; Set at 275 psig / 19 bar
H284-312	3 x 2 in. NPT Brass Relief Valve; Set at 312 psig / 21.5 bar
H5114-250	3 x 2 in. NPT Stainless Steel Relief Valve; Set at 250 psig / 17.2 bar
H5114-265	3 x 2 in. NPT Stainless Steel Relief Valve; Set at 265 psig / 18.3 bar
H5114-275	3 x 2 in. NPT Stainless Steel Relief Valve; Set at 275 psig / 19 bar
H5118-250	3 X 2 in. SST Relief Valve, UL, Nitrile (NBR), Set at 250 psig / 17.2 bar
H5118-265	3 X 2 in. SST Relief Valve, UL, Nitrile (NBR), Set at 265 psi / 18.3 bar
H722-125	2 in. NPT Relief Valve; Set at 125 psi / 8.6 bar; Nitrile (NBR) Trim
H722-156	2 in. NPT Relief Valve; Set at 156 psi / 10.8 bar; Nitrile (NBR) Trim
H722-250	2 in. NPT Relief Valve; Set at 250 psi / 17.2 bar; Nitrile (NBR) Trim
H722-265	2 in. NPT Relief Valve; Set at 265 psi / 18.3 bar; Nitrile (NBR) Trim
H722-275	2 in. NPT Relief Valve; Set at 275 psi / 19 bar; Nitrile (NBR) Trim
H722-312	2 in. NPT Relief Valve; Set at 312 psi / 21.5 bar; Nitrile (NBR) Trim
H733-125	3 in. Relief Valve; SST; 125 psi / 8.6 bar set
H733-156	3 in. Relief Valve; SST; 156 psi / 10.8 bar set
H733-250	3 in. Relief Valve; SST; 250 psi / 17.2 bar set
H733-265	3 in. Relief Valve; SST; 265 psi / 18.3 bar set
H733-275	3 in. Relief Valve; SST; 275 psi / 19.0 bar set
H733-312	3 in. Relief Valve; SST; 312 psi / 21.5 bar set
H733F3-250	3 in. Relief Valve; ASME CL300 RF Flange; 250 psi / 21.5 bar / 17.2 bar set; Nitrile (NBR)
H733F3-265	3 in. Relief Valve; ASME CL300 RF Flange, 265 psi / 18.3 bar set, Nitrile (NBR)

Type No.	Description
H8114-1	2 in. NPT SST Relief Valve; Non-UL; 100 to 149 psig / 6.9 to 10.3 bar Spring
H8114-2	2 in. NPT SST Relief Valve; Non-UL; 150 to 200 psig / 10.3 to 13.8 bar Spring
H8114-3	2 in. NPT SST Relief Valve; Non-UL; 201 to 275 psig / 13.9 to 19 bar Spring
H8114-4	2 in. NPT SST Relief Valve; Non-UL; 276 to 330 psig / 19 to 22.8 bar Spring
H8114-5	2 in. NPT SST Relief Valve; Non-UL; 331 to 400 psig / 22.8 to 27.6 bar Spring
H8114E-1	2 in. NPT SST Relief Valve; Non-UL; 100 to 149 psig / 6.9 to 10.3 bar Spring; with EPDM Trim
H8114E-2	2 in. NPT SST Relief Valve; Non-UL; 150 to 200 psig / 10.3 to 13.8 bar Spring; with EPDM Trim
H8114E-3	2 in. NPT SST Relief Valve; Non-UL; 201 to 275 psig / 13.9 to 19 bar Spring; with EPDM Trim
H8114E-4	2 in. NPT SST Relief Valve; Non-UL; 276 to 330 psig / 19 to 22.8 bar Spring; with EPDM Trim
H8114E-5	2 in. NPT SST Relief Valve; Non-UL; 331 to 400 psig / 22.8 to 27.6 bar Spring; with EPDM Trim
H8114K-1	2 in. NPT SST Relief Valve; Non-UL; 100 to 149 psig / 6.9 to 10.3 bar Spring; with FFKM Trim
H8114K-2	2 in. NPT SST Relief Valve; Non-UL; 150 to 200 psig / 10.3 to 13.8 bar Spring; with FFKM Trim
H8114K-3	2 in. NPT SST Relief Valve; Non-UL; 201 to 275 psig / 13.9 to 19 bar Spring; with FFKM Trim
H8114K-4	2 in. NPT SST Relief Valve; Non-UL; 276-330 psig / 19 to 22.8 bar Spring; with FFKM Trim
H8114K-5	2 in. NPT SST Relief Valve; Non-UL; 331 to 400 psig / 22.8 to 27.6 bar Spring; with FFKM Trim
H8114N-1	2 in. NPT SST Relief Valve; Non-UL; 100 to 149 psig / 6.9 to 10.3 bar Spring; with Neoprene (CR) Trim
H8114N-2	2 in. NPT SST Relief Valve; Non-UL; 150 to 200 psig / 10.3 to 13.8 bar Spring; with Neoprene (CR) Trim
H8114N-3	2 in. NPT SST Relief Valve; Non-UL; 201 to 275 psig / 13.9 to 19 bar Spring; with Neoprene (CR) Trim
H8114N-4	2 in. NPT SST Relief Valve; Non-UL; 276 to 330 psig / 19 to 22.8 bar Spring; with Neoprene (CR) Trim
H8114N-5	2 in. NPT SST Relief Valve; Non-UL; 331 to 400 psig / 22.8 to 27.6 bar Spring; with Neoprene (CR) Trim
H8114V-1	2 in. NPT SST Relief Valve; Non-UL; 100 to 149 psig / 6.9 to 10.3 bar Spring; with Fluorocarbon (FKM) Trim
H8114V-2	2 in. NPT SST Relief Valve; Non-UL; 150 to 200 psig / 10.3 to 13.8 bar Spring; with Fluorocarbon (FKM) Trim
H8114V-3	2 in. NPT SST Relief Valve; Non-UL; 201 to 275 psig / 13.9 to 19 bar Spring; with Fluorocarbon (FKM) Trim
H8114V-4	2 in. NPT SST Relief Valve; Non-UL; 276 to 330 psig / 19 to 22.8 bar Spring; with Fluorocarbon (FKM) Trim
H8114V-5	2 in. NPT SST Relief Valve; Non-UL; 331 to 400 psig / 22.8 to 27.6 bar Spring; with Fluorocarbon (FKM) Trim
H8118-3	3 X 2 in. SST Relief Valve, Nitrile (NBR), 201 to 275 psig / 13.9 to 19 bar set
H8118N-3	3 X 2 in. SST Relief Valve, Neoprene (CR), 201 to 275 psig / 13.9 to 19 bar set
H822-1	2 in. NPT Relief Valve; 100 to 150 psi / 6.9 to 10.3 bar Spring Range; Nitrile (NBR) Trim
H822-2	2 in. NPT Relief Valve; 151 to 250 psi / 10.4 to 17.2 bar Spring Range; Nitrile (NBR) Trim
H822-3	2 in. NPT Relief Valve; 251 to 400 psi / 17.3 to 27.6 bar Spring Range; Nitrile (NBR) Trim
H822E-1	2 in. NPT Relief Valve; 100 to 150 psi / 6.9 to 10.3 bar Spring Range; EPDM Trim
H822E-2	2 in. NPT Relief Valve; 151 to 250 psi / 10.4 to 17.2 bar Spring Range; EPDM Trim
H822E-3	2 in. NPT Relief Valve; 251 to 400 psi / 17.3 to 27.6 bar Spring Range; EPDM Trim
H822K-1	2 in. NPT Relief Valve; 100 to 150 psi / 6.9 to 10.3 bar Spring Range; Kalrez® Trim
H822K-2	2 in. NPT Relief Valve; 151 to 250 psi / 10.4 to 17.2 bar Spring Range; Kalrez® Trim

BS&T - Relief Valves (continued)

Type No.	Description
H822K-3	2 in. NPT Relief Valve; 251 to 400 psi / 17.3 to 27.6 bar Spring Range; Kalrez® Trim
H822N-1	2 in. NPT Relief Valve; 100 to 150 psig / 6.9 to 10.3 bar Spring Range; Neoprene (CR) Trim
H822N-2	2 in. NPT Relief Valve; 151 to 250 psig / 10.4 to 17.2 bar Spring Range; Neoprene (CR) Trim
H822N-3	2 in. NPT Relief Valve; 251 to 400 psig / 17.3 to 27.6 bar Spring Range; Neoprene (CR) Trim
H822V-1	2 in. NPT Relief Valve; 100 to 150 psig / 6.9 to 10.3 bar Spring Range; Viton® Trim
H822V-2	2 in. NPT Relief Valve; 151 to 250 psig / 10.4 to 17.2 bar Spring Range; Viton® Trim
H822V-3	2 in. NPT Relief Valve; 251 to 400 psig / 17.3 to 27.6 bar Spring Range; Viton® Trim
H833-1	3 in. Relief Valve, Non-UL®; 100 to 149 psi / 6.9 to 10.3 bar; Nitrile (NBR)
H833-2	3 in. Relief Valve, Non-UL; 150 to 200 psi / 10.3 to 13.8 bar; Nitrile (NBR)
H833-3	3 in. Relief Valve, Non-UL; 201 to 275 psi / 13.9 to 19 bar; Nitrile (NBR)
H833-4	3 in. Relief Valve, Non-UL; 276 to 330 psi / 19 to 22.8 bar; Nitrile (NBR)
H833-5	3 in. Relief Valve, Non-UL; 331 to 400 psi / 22.8 to 27.6 bar; Nitrile (NBR)
H833E-1	3 in. Relief Valve, Non-UL; 100 to 149 psi / 6.9 to 10.3 bar; Ethylene Propylene
H833E-2	3 in. Relief Valve, Non-UL; 150 to 200 psi / 10.3 to 13.8 bar; Ethylene Propylene
H833E-3	3 in. Relief Valve, Non-UL; 201 to 275 psi / 13.9 to 19 bar; Ethylene Propylene
H833E-4	3 in. Relief Valve, Non-UL; 276 to 300 psi / 19 to 20.7 bar; Ethylene Propylene
H833E-5	3 in. Relief Valve, Non-UL; 331 to 400 psi / 22.8 to 27.6 bar; Ethylene Propylene
H833EF3-3	3 in. Relief Valve, Non-UL; CL300 RF Flange, 201 to 275 psi / 13.9 to 19 bar range, Ethylene Propylene
H833F3-3	3 in. Relief Valve, Non-UL; CL300 RF Flange, 201 to 275 psi / 13.9 to 19 bar range, Nitrile (NBR)
H833K-1	3 in. Relief Valve, Non-UL; 100 to 149 psi / 6.9 to 10.3 bar, Kalrez®
H833K-2	3 in. Relief Valve, Non-UL; 150 to 200 psi / 10.3 to 13.8 bar, Kalrez®
H833K-3	3 in. Relief Valve, Non-UL; 201 to 275 psi / 13.9 to 19 bar, Kalrez®
H833K-4	3 in. Relief Valve, Non-UL; 276 to 330 psi / 19 to 22.8 bar, Kalrez®
H833K-5	3 in. Relief Valve, Non-UL; 331 to 400 psi / 22.8 to 27.6 bar, Kalrez®
H833KF3-3	3 in. Relief Valve, Non-UL; CL300 RF Flange, 201 to 275 psi / 13.9 to 19 bar range, Kalrez®
H833N-1	3 in. Relief Valve, Non-UL; 100 to 149 psi / 6.9 to 10.3 bar, Neoprene (CR)
H833N-2	3 in. Relief Valve, Non-UL; 150 to 200 psi / 10.3 to 13.8 bar, Neoprene (CR)
H833N-3	3 in. Relief Valve, Non-UL; 201 to 275 psi / 13.9 to 19 bar; Neoprene (CR)
H833N-4	3 in. Relief Valve, Non-UL; 276 to 330 psi / 19 to 22.8 bar; Neoprene (CR)
H833N-5	3 in. Relief Valve, Non-UL; 331 to 400 psi / 22.8 to 27.6 bar, Neoprene (CR)
H833NF3-3	3 in. Relief Valve; CL300 RF Flange; 201 to 275 psi / 13.9 to 19 bar range; Non-UL; Neoprene (CR)
H833V-1	3 in. Relief Valve; Non-UL; 100 to 149 psi / 6.9 to 10.3 bar; Fluorocarbon (FKM)
H833V-2	3 in. Relief Valve; Non-UL; 150 to 200 psi / 10.3 to 13.8 bar; Fluorocarbon (FKM)
H833V-3	3 in. Relief Valve; Non-UL; 201 to 275 psi / 13.9 to 19 bar; Fluorocarbon (FKM)
H833V-4	3 in. Relief Valve; Non-UL; 276 to 330 psi / 19 to 22.8 bar; Fluorocarbon (FKM)
H833V-5	3 in. Relief Valve; Non-UL; 331 to 400 psi / 22.8 to 27.6 bar; Fluorocarbon (FKM)
H833VF3-3	3 in. Relief Valve; CL300 RF Flange; 201 to 275 psi / 13.9 to 19 bar Range; Non-UL; Fluorocarbon (FKM)
H884-1	2 in. NPT Brass Relief Valve; Non-UL; 100 to 149 psig / 6.9 to 10.3 bar Spring
H884-2	2 in. NPT Brass Relief Valve; Non-UL; 150 to 200 psig / 10.3 to 13.8 bar Spring
H884-3	2 in. NPT Brass Relief Valve; Non-UL; 201 to 275 psig / 13.9 to 19 bar Spring
H884-4	2 in. NPT Brass Relief Valve; Non-UL; 276 to 330 psig / 19 to 22.8 bar Spring
H884-5	2 in. NPT Brass Relief Valve; Non-UL; 331 to 400 psig / 22.8 to 27.6 bar Spring

Type No.	Description
H884E-1	2 in. NPT Brass Relief Valve; Non-UL; 100 to 149 psig / 6.9 to 10.3 bar Spring; with EPDM Trim
H884E-2	2 in. NPT Brass Relief Valve; Non-UL; 150 to 200 psig / 10.3 to 13.8 bar Spring; with EPDM Trim
H884E-3	2 in. NPT Brass Relief Valve; Non-UL; 201 to 275 psig / 13.9 to 19 bar Spring; with EPDM Trim
H884E-4	2 in. NPT Brass Relief Valve; Non-UL; 276 to 330 psig / 19 to 22.8 bar Spring; with EPDM Trim
H884E-5	2 in. NPT Brass Relief Valve; Non-UL; 331 to 400 psig / 22.8 to 27.6 bar Spring; with EPDM Trim
H884K-1	2 in. NPT Brass Relief Valve; Non-UL; 100 to 149 psig / 6.9 to 10.3 bar Spring; with FFKM Trim
H884K-2	2 in. NPT Brass Relief Valve; Non-UL; 150 to 200 psig / 10.3 to 13.8 bar Spring; with FFKM Trim
H884K-3	2 in. NPT Brass Relief Valve; Non-UL; 201 to 275 psig / 13.9 to 19 bar Spring; with FFKM Trim
H884K-4	2 in. NPT Brass Relief Valve; Non-UL; 276 to 330 psig / 19 to 22.8 bar Spring; with FFKM Trim
H884K-5	2 in. NPT Brass Relief Valve; Non-UL; 331 to 400 psig / 22.8 to 27.6 bar Spring; with FFKM Trim
H884N-1	2 in. NPT Brass Relief Valve; Non-UL; 100 to 149 psig / 6.9 to 10.3 bar Spring; with Neoprene (CR) Trim
H884N-2	2 in. NPT Brass Relief Valve; Non-UL; 150 to 200 psig / 10.3 to 13.8 bar Spring; with Neoprene (CR) Trim
H884N-3	2 in. NPT Brass Relief Valve; Non-UL; 201 to 275 psig / 13.9 to 19 bar Spring; with Neoprene (CR) Trim
H884N-4	2 in. NPT Brass Relief Valve; Non-UL; 276 to 330 psig / 19 to 22.8 bar Spring; with Neoprene (CR) Trim
H884N-5	2 in. NPT Brass Relief Valve; Non-UL; 331 to 400 psig / 22.8 to 27.6 bar Spring; with Neoprene (CR) Trim
H884V-1	2 in. NPT Brass Relief Valve; Non-UL; 100 to 149 psig / 6.9 to 10.3 bar Spring; with Fluorocarbon (FKM) Trim
H884V-2	2 in. NPT Brass Relief Valve; Non-UL; 150 to 200 psig / 10.3 to 13.8 bar Spring; with Fluorocarbon (FKM) Trim
H884V-3	2 in. NPT Brass Relief Valve; Non-UL; 201 to 275 psig / 13.9 to 19 bar Spring; with Fluorocarbon (FKM) Trim
H884V-4	2 in. NPT Brass Relief Valve; Non-UL; 276 to 330 psig / 19 to 22.8 bar Spring; with Fluorocarbon (FKM) Trim
H884V-5	2 in. NPT Brass Relief Valve; Non-UL; 331 to 400 psig / 22.8 to 27.6 bar Spring; with Fluorocarbon (FKM) Trim

BS&T Bypass and Backpressure Valves

Type No.	Description
N100-16-1	2 in. NPT Elbow Bypass Valve; 25 to 75 psid / 1.7 to 5.2 bar d Spring
N100-16-2	2 in. NPT Elbow Bypass Valve; 50 to 150 psid / 3.4 to 10.3 bar d Spring
N100A-08-1	1 in. NPT Elbow Bypass Valve; 25 to 75 psid / 1.7 to 5.2 bar d Spring
N100A-08-2	1 in. NPT Elbow Bypass Valve; 50 to 150 psid / 3.4 to 10.3 bar d Spring
N100A-10-1	1-1/4 in. NPT Elbow Bypass Valve; 25 to 75 psid / 1.7 to 5.2 bar d Spring
N100A-10-2	1-1/4 in. NPT Elbow Bypass Valve; 50 to 150 psid / 3.4 to 10.3 bar d Spring
N100A-12-1	1-1/2 in. NPT Elbow Bypass Valve; 25 to 75 psid / 1.7 to 5.2 bar d Spring
N100A-12-2	1-1/2 in. NPT Elbow Bypass Valve; 50 to 150 psid / 3.4 to 10.3 bar d Spring
N110-06-1	3/4 in. NPT Straight Bypass Valve; 25 to 75 psid / 1.7 to 5.2 bar d Spring
N110-06-2	3/4 in. NPT Straight Bypass Valve; 50 to 150 psid / 3.4 to 10.3 bar d Spring
N110-08-1	1 in. NPT Straight Bypass Valve; 25 to 75 psid / 1.7 to 5.2 bar d Spring
N110-08-2	1 in. NPT Straight Bypass Valve; 50 to 150 psid / 3.4 to 10.3 bar d Spring
N120-06-3	3/4 in. NPT Straight Backpressure Valve; 10 to 20 psid / 0.69 to 1.4 bar d Spring
N120-08-3	1 in. NPT Straight Backpressure Valve; 10 to 20 psid / 0.69 to 1.4 bar d Spring

### BS&T - Internal Valves

Type No.	Description
C403-24-15	3 in. Flanged Internal Valve; Double Flange Body; Legacy Style; 150 GPM / 568 l/min Spring
C403-24-20	3 in. Flanged Internal Valve; Double Flange Body; Legacy Style; 200 GPM / 757 l/min Spring
C403-24-25	3 in. Flanged Internal Valve; Double Flange Body; Legacy Style; 250 GPM / 946 l/min Spring
C403-24-40	3 in. Flanged Internal Valve; Double Flange Body; Legacy Style; 400 GPM / 1514 l/min Spring
C403-24-50	3 in. Flanged Internal Valve; Double Flange Body; Legacy Style; 500 GPM / 1893 l/min Spring
C404-24-15	3 in. Flanged Internal Valve; Single Flange Body; Legacy Style; 150 GPM / 568 l/min Spring
C404-24-20	3 in. Flanged Internal Valve; Single Flange Body; Legacy Style; 200 GPM / 757 l/min Spring
C404-24-25	3 in. Flanged Internal Valve; Single Flange Body; Legacy Style; 250 GPM / 946 l/min Spring
C404-24-40	3 in. Flanged Internal Valve; Single Flange Body; Legacy Style; 400 GPM / 1514 l/min Spring
C404-24-50	3 in. Flanged Internal Valve; Single Flange Body; Legacy Style; 500 GPM / 1893 l/min Spring
C404-32-100	4 in. Flanged Internal Valve; 1000 GPM / 3785 l/min Spring
C404-32-34	4 in. Flanged Internal Valve; 340 GPM / 1287 l/min Spring
C404-32-40	4 in. Flanged Internal Valve; 400 GPM / 1514 l/min Spring
C404-32-60	4 in. Flanged Internal Valve; 600 GPM / 2271 l/min Spring
C404-32-80	4 in. Flanged Internal Valve; 800 GPM / 3028 l/min Spring
C404A32-100	4 in. Flanged Internal Valve; 1000 GPM / 3785 l/min Spring; with Type P614 Actuator
C404A32-34	4 in. Flanged Internal Valve; 340 GPM / 1287 l/min Spring; with Type P614 Actuator
C404A32-40	4 in. Flanged Internal Valve; 400 GPM / 1514 l/min Spring; with Type P614 Actuator
C404A32-60	4 in. Flanged Internal Valve; 600 GPM / 2271 l/min Spring; with Type P614 Actuator
C404A32-80	4 in. Flanged Internal Valve; 800 GPM / 3028 l/min Spring; with Type P614 Actuator
C404FA32-10	4 in. Flanged Internal Valve; France; Type P614 Air Actuator; 1000 GPM / 3785 l/min Spring
C404M32-100	4 in. Flanged Internal Valve; 1000 GPM / 3785 l/min Spring; with Type P313 Operating Lever
C404M32-34	4 in. Flanged Internal Valve; 340 GPM / 1287 l/min Spring; with Type P313 Operating Lever
C404M32-40	4 in. Flanged Internal Valve; 400 GPM / 1514 l/min Spring; with Type P313 Operating Lever
C404M32-60	4 in. Flanged Internal Valve; 600 GPM / 2271 l/min Spring; with Type P313 Operating Lever
C404M32-80	4 in. Flanged Internal Valve; 800 GPM / 3028 l/min Spring; with Type P313 Operating Lever
C407-10-04	1-1/4 in. NPT Internal Valve; Straight-Through Body; 40 GPM / 151 l/min Spring
C407-10-05	1-1/4 in. NPT Internal Valve; Straight-Through Body; 50 GPM / 189 l/min Spring
C407-10-08	1-1/4 in. NPT Internal Valve; Straight-Through Body; 80 GPM / 303 l/min Spring
C407M10-04	1-1/4 in. NPT Internal Valve with Type P341 Remote Release; 40 GPM / 151 l/min Spring
C407M10-05	1-1/4 in. NPT Internal Valve with Type P341 Remote Release; 50 GPM / 189 l/min Spring
C407M10-08	1-1/4 in. NPT Internal Valve with Type P341 Remote Release; 80 GPM / 303 l/min Spring

Type No.	Description
C471-16-10	2 in. NPT Internal Valve; Tee Body; 105 GPM / 397 l/min Spring
C471-16-15	2 in. NPT Internal Valve; Tee Body; 150 GPM / 568 l/min Spring
C471-16-25	2 in. NPT Internal Valve; Tee Body; 250 GPM / 946 l/min Spring
C471-24-16	3 in. NPT Internal Valve; Tee Body; 160 GPM / 606 l/min Spring
C471-24-26	3 in. NPT Internal Valve; Tee Body; 265 GPM / 1003 l/min Spring
C471-24-37	3 in. NPT Internal Valve; Tee Body; 375 GPM / 1419 l/min Spring
C471-24-46	3 in. NPT Internal Valve; Tee Body; 460 GPM / 1741 l/min Spring
C471M-16-15	2 in. NPT Internal Valve; Tee Body; 150 GPM / 568 l/min Spring; with Type P340 Latch
C471M-16-25	2 in. NPT Internal Valve; Tee Body; 250 GPM / 946 l/min Spring; with Type P340 Latch
C471M-24-37	3 in. NPT Internal Valve; Tee Body; 375 GPM / 1419 l/min Spring; with Type P340 Latch
C477-16-10	2 in. NPT Internal Valve; Straight-Through Body; 105 GPM / 397 l/min Spring
C477-16-15	2 in. NPT Internal Valve; Straight-Through Body; 150 GPM / 568 l/min Spring
C477-16-25	2 in. NPT Internal Valve; Straight-Through Body; 250 GPM / 946 l/min Spring
C477-24-16	3 in. NPT Internal Valve; Straight-Through Body; 160 GPM / 606 l/min Spring
C477-24-26	3 in. NPT Internal Valve; Straight-Through Body; 265 GPM / 1003 l/min Spring
C477-24-37	3 in. NPT Internal Valve; Straight-Through Body; 375 GPM / 1419 l/min Spring
C477-24-46	3 in. NPT Internal Valve; Straight-Through Body; 460 GPM / 1741 l/min Spring
C477M-16-10	2 in. NPT Internal Valve; Straight-Through Body; 105 GPM / 397 l/min Spring; with Type P340 Latch
C477M-16-25	2 in. NPT Internal Valve; Straight-Through Body; 250 GPM / 946 l/min Spring; with Type P340 Latch
C477M-24-16	3 in. NPT Internal Valve; Straight-Through Body; 160 GPM / 606 l/min Spring; with Type P340 Latch
C477M-24-26	3 in. NPT Internal Valve; Straight-Through Body; 265 GPM / 1003 l/min Spring; with Type P340 Latch
C477M-24-37	3 in. NPT Internal Valve; Straight-Through Body; 375 GPM / 1419 l/min Spring; with Type P340 Latch
C477M-24-46	3 in. NPT Internal Valve; Straight-Through Body; 460 GPM / 1741 l/min Spring; with Type P340 Latch
C483-24-16	3 in. Flange Internal Valve; Double Flange Body; 160 GPM / 606 l/min Spring
C483-24-26	3 in. Flange Internal Valve; Double Flange Body; 265 GPM / 1003 l/min Spring
C483-24-40	3 in. Flange Internal Valve; Double Flange Body; 400 GPM / 1514 l/min Spring
C484-24-16	3 in. Flange Internal Valve; Single Flange Body; 160 GPM / 606 l/min Spring
C484-24-25	3 in. Flange Internal Valve; Single Flange Body; 250 GPM / 946 l/min Spring
C484-24-40	3 in. Flange Internal Valve; Single Flange Body; 400 GPM / 1514 l/min Spring
C486-24-16	3 in. CL300 Flange Inlet x FNPT Outlet Body; 160 GPM / 606 l/min Spring
C486-24-26	3 in. CL300 Flange Inlet x FNPT Outlet Body; 265 GPM / 1003 l/min Spring
C486-24-37	3 in. CL300 Flange Inlet x FNPT Outlet Body; 375 GPM / 1419 l/min Spring
C486-24-46	3 in. CL300 Flange Inlet x FNPT Outlet Body; 460 GPM / 1741 l/min Spring



BS&T - Internal Valves (continued)

Type No.	Description
C803-24-15	3 in. NPT; Regulator; Internal Valve; 150 GPM / 568 l/min
C803-24-20	3 in. NPT; Regulator; Internal Valve; 200 GPM / 757 l/min
C803-24-25	3 in. NPT; Regulator; Internal Valve; 250 GPM / 946 l/min
C803-24-40	3 in. NPT; Regulator; Internal Valve; 400 GPM / 1514 l/min
C803E-24-15	3 in. NPT; Regulator; Internal Valve; 150 GPM / 568 l/min
C804-24-15	3 in. Single Flange Regulator; Internal Valve Screen; 150 GPM / 568 l/min
C804-24-20	3 in. Single Flange Regulator; Internal Valve Screen; 200 GPM / 757 l/min
C804-24-25	3 in. Single Flange Regulator; Internal Valve Screen; 250 GPM / 946 l/min
C804-24-40	3 in. Single Flange Regulator; Internal Valve Screen; 400 GPM / 1514 l/min
C804-32-34	4 in. Flanged Internal Valve; Non-UL®; 340 GPM / 1287 l/min Spring
C804-32-40	4 in. Flanged Internal Valve; Non-UL; 400 GPM / 1514 l/min Spring
C804-32-60	4 in. Flanged Internal Valve; Non-UL; 600 GPM / 2271 l/min Spring
C804-32-80	4 in. Flanged Internal Valve; Non-UL; 800 GPM / 3028 l/min Spring
C804AT32-40	4 in. Flanged Internal Valve; Non-UL; 400 GPM / 1514 l/min Spring; with Type P614 Actuator; with TFE Trim
C804AT32-60	4 in. Flanged Internal Valve; Non-UL; 600 GPM / 2271 l/min Spring; with Type P614 Actuator; with TFE Trim
C804AV32-40	4 in. Flanged Internal Valve; Non-UL; 400 GPM / 1514 l/min Spring; with Type P614 Actuator; with Fluorocarbon (FKM) Trim
C804AV32-60	4 in. Flanged Internal Valve; Non-UL; 600 GPM / 2271 l/min Spring; with Type P614 Actuator; with Fluorocarbon (FKM) Trim
C804E-24-15	3 in. Flanged Internal Valve; Single Flange Body; Legacy Style; Non-UL; 150 GPM / 568 l/min Spring; with EPDM Trim
C804E-24-40	3 in. Flange Regulator; Internal Valve; with Ethylene Propylene Trim; 400 GPM / 1514 l/min
C804F-24-50	3 in. Flange Regulator; Internal Valve; for France
C804H32-34	4 in. Flanged Internal Valve; Non-UL; Y Grade NGL Trim; 340 GPM / 1287 l/min Spring
C804H32-40	4 in. Flanged Internal Valve; Non-UL; Y Grade NGL Trim; 400 GPM / 1514 l/min Spring
C804H32-60	4 in. Flanged Internal Valve; Non-UL; Y Grade NGL Trim; 600 GPM / 2271 l/min Spring
C804H32-80	4 in. Flanged Internal Valve; Non-UL; Y Grade NGL Trim; 800 GPM / 3028 l/min Spring
C804H32-100	4 in. Flanged Internal Valve; Non-UL; Y Grade NGL Trim; 1000 GPM / 3785 l/min Spring
C804HA32-100	4 in. Flanged Internal Valve; Non-UL; 1000 GPM / 3785 l/min Spring; Type P614 Actuator; Y Grade NGL Trim
C804HA32-34	4 in. Flanged Internal Valve; Non-UL; 340 GPM / 1287 l/min Spring; Type P614 Actuator; Y Grade NGL Trim
C804HA32-40	4 in. Flanged Internal Valve; Non-UL; 400 GPM / 1514 l/min Spring; Type P614 Actuator; Y Grade NGL Trim
C804HA32-60	4 in. Flanged Internal Valve; Non-UL; 600 GPM / 2271 l/min Spring; Type P614 Actuator; Y Grade NGL Trim
C804HA32-80	4 in. Flanged Internal Valve; Non-UL; 800 GPM / 3028 l/min Spring; Type P614 Actuator; Y Grade NGL Trim
C804HM32-100	4 in. Flanged Internal Valve; Non-UL; 1000 GPM / 3785 l/min Spring; Type P313 Operating Lever; Y Grade NGL Trim
C804HM32-34	4 in. Flanged Internal Valve; Non-UL; 340 GPM / 1287 l/min Spring; Type P313 Operating Lever; Y Grade NGL Trim

Type No.	Description
C804HM32-40	4 in. Flanged Internal Valve; Non-UL; 400 GPM / 1514 l/min Spring; Type P313 Operating Lever; Y Grade NGL Trim
C804HM32-60	4 in. Flanged Internal Valve; Non-UL; 600 GPM / 2271 l/min Spring; Type P313 Operating Lever; Y Grade NGL Trim
C804HM32-80	4 in. Flanged Internal Valve; Non-UL; 800 GPM / 3028 l/min Spring; Type P313 Operating Lever; Y Grade NGL Trim
C804K-24-15	3 in. Flange Regulator; Internal Valve with Kalrez® Trim; 150 GPM / 568 l/min
C804K-24-25	3 in. Flange Reg; Internal Valve with Kalrez® Trim; 250 GPM / 946 l/min
C804K-24-40	3 in. Flange Reg; Internal Valve with Kalrez® Trim; 400 GPM / 1514 l/min
C804MT32-34	4 in. Flanged Internal Valve; Non-UL; 340 GPM / 1287 l/min Spring; with Type P313 Operating Lever; with TFE Trim
C804MT32-60	4 in. Flanged Internal Valve; Non-UL; 600 GPM / 2271 l/min Spring; with Type P313 Operating Lever; with TFE Trim
C804MT32-80	4 in. Flanged Internal Valve; Non-UL; 800 GPM / 3028 l/min Spring; with Type P313 Operating Lever; with TFE Trim
C804MV32-100	4 in. Flanged Internal Valve; Non-UL; 1000 GPM / 3785 l/min Spring; with Type P313 Operating Lever; with Fluorocarbon (FKM) Trim
C804MV32-34	4 in. Flanged Internal Valve; Non-UL; 340 GPM / 1287 l/min Spring; with Type P313 Operating Lever; with Fluorocarbon (FKM) Trim
C804MV32-60	4 in. Flanged Internal Valve; Non-UL; 600 GPM / 2271 l/min Spring; with Type P313 Operating Lever; with Fluorocarbon (FKM) Trim
C804MV32-80	4 in. Flanged Internal Valve; Non-UL; 800 GPM / 3028 l/min Spring; with Type P313 Operating Lever; with Fluorocarbon (FKM) Trim
C804N-24-40	3 in. Flange Regulator; Internal Valve; Neoprene (CR) Trim; 400 GPM / 1514 l/min
C804T-24-15	3 in. Flange Regulator; Internal Valve; with Teflon® Trim; 150 GPM / 568 l/min
C804T-24-20	3 in. Flange Regulator; Internal Valve; with Teflon® Trim; 200 GPM / 757 l/min
C804T-24-25	3 in. Flange Regulator; Internal Valve; with Teflon® Trim; 250 GPM / 946 l/min
C804T-24-40	Internal Valve
C804T-32-34	4 in. Flange Regulator; Internal Valve; with Teflon® Trim; 340 GPM / 1287 l/min
C804T-32-60	4 in. Flange Regulator; Internal Valve; with Teflon® Trim; 600 GPM / 2271 l/min
C804V-24-15	3 in. Flange Regulator; Internal Valve; with Viton® Trim; 150 GPM / 568 l/min
C804V-24-20	3 in. Flange Regulator; Internal Valve; with Viton® Trim; 200 GPM / 757 l/min
C804V-24-25	3 in. Flange Regulator; Internal Valve; with Viton® Trim; 250 GPM / 946 l/min
C804V-24-50	3 in. Flange Regulator; Internal Valve; with Viton® Trim; 500 GPM / 1893 l/min
C804V-32-40	4 in. Flange Regulator; Internal Valve; with Viton® Trim; 400 GPM / 1514 l/min
C807-10-04	1-1/4 in. NPT Internal Valve, Straight-Through Body, Non-UL, 40 GPM / 151 l/min Spring
C807-10-05	1-1/4 in. NPT Internal Valve; Straight-Through Body; Non-UL; 50 GPM / 189 l/min Spring
C807-10-08	1-1/4 in. NPT Internal Valve; Straight-Through Body; Non-UL; 80 GPM / 303 l/min Spring
C807-16-15	2 in. NPT; Regulator; Internal Valve; Straight-Through Body; 150 GPM / 568 l/min
C807-16-25	2 in. NPT; Regulator; Internal Valve; Straight-Through Body; 250 GPM / 946 l/min
C807E-16-10	2 in. NPT; Regulator; Internal Valve; Straight-Through Body; with Ethylene Propylene Trim; 100 GPM / 379 l/min
C807E-16-15	2 in. NPT; Regulator; Internal Valve; Straight-Through Body; with Ethylene Propylene Trim; 150 GPM / 568 l/min

### BS&T - Internal Valves (continued)

Type No.	Description
C807E-16-25	2 in. NPT; Regulator; Internal Valve; Straight-Through Body; with Ethylene Propylene Trim; 250 GPM / 946 l/min
C807K-16-25	2 in. NPT; Regulator; Internal Valve; Straight-Through Body; with Kalrez® Trim; 250 GPM / 946 l/min
C807N-16-15	2 in. NPT; Regulator; Internal Valve; Straight-Through Body; 150 GPM / 568 l/min
C807N-16-25	2 in. NPT; Regulator; Internal Valve; Straight-Through Body; 250 GPM / 946 l/min
C807S-10-04	1-1/4 in. NPT Regulator; Internal Valve; Stainless-Steel Body; Non-UL®; 40 GPM / 151 l/min Spring
C807S-10-05	1-1/4 in. NPT Regulator; Internal Valve; Stainless-Steel Body; Non-UL; 50 GPM / 189 l/min Spring
C807S-10-08	1-1/4 in. NPT Regulator; Internal Valve; Stainless-Steel Body; Non-UL; 80 GPM / 303 l/min Spring
C807S-16-15	2 in. NPT; Regulator; Internal Valve; Straight-Through Body; 150 GPM / 568 l/min
C807S-16-25	2 in. NPT; Regulator; Internal Valve; Straight-Through Body; 250 GPM / 946 l/min
C807SE16-10	2 in. NPT; Regulator; Internal Valve; Straight-Through Body; with Ethylene Propylene Trim; 100 GPM / 379 l/min
C807SV10-05	1-1/4 in. NPT; Regulator; Internal Valve; Straight-Through Body; with Viton® Trim; 50 GPM / 189 l/min
C807SV16-25	2 in. NPT; Regulator; Internal Valve; Straight-Through Body; with Viton® Trim; 250 GPM / 946 l/min
C807T-10-05	1-1/4 in. NPT; Regulator; Internal Valve; Straight-Through Body; Non-UL; 50 GPM / 189 l/min Spring; with TFE Trim
C807T-10-08	1-1/4 in. NPT; Regulator; Internal Valve; Straight-Through Body; Non-UL; 80 GPM / 303 l/min Spring; with TFE Trim
C807T-16-10	2 in. NPT; Regulator; Internal Valve; with Teflon® Trim; 100 GPM / 379 l/min
C807T-16-15	2 in. NPT; Regulator; Internal Valve; with Teflon® Trim; 150 GPM / 568 l/min
C807T-16-25	2 in. NPT; Regulator; Internal Valve; with Teflon® Trim; 250 GPM / 946 l/min
C807V-10-04	1-1/4 in. NPT; Regulator; Internal Valve; Straight-Through Body; Non-UL; 40 GPM / 151 l/min Spring, with Fluorocarbon (FKM) Trim
C807V-10-05	1-1/4 in. NPT; Regulator; Internal Valve; Straight-Through Body; Non-UL; 50 GPM / 189 l/min Spring; with Fluorocarbon (FKM) Trim
C807V-10-08	1-1/4 in. NPT; Regulator; Internal Valve; Straight-Through Body; Non-UL; 80 GPM / 303 l/min Spring; with Fluorocarbon (FKM) Trim
C807V-16-10	2 in. NPT; Regulator; Internal Valve; with Viton® Trim; 100 GPM / 379 l/min
C807V-16-15	2 in. NPT; Regulator; Internal Valve; with Viton® Trim; 150 GPM / 568 l/min
C807V-16-25	2 in. NPT; Regulator; Internal Valve; with Viton® Trim; 250 GPM / 946 l/min
C821E-16-25	2 in. NPT; Regulator; Internal Valve; Tee Body; with Ethylene Propylene Trim; 250 GPM / 946 l/min
C821E-24-40	3 in. NPT; Regulator; Internal Valve; Tee Body; with Ethylene Propylene Trim; 400 GPM / 1514 l/min
C821K-16-25	2 in. NPT; Regulator; Internal Valve; Tee Body; with Kalrez® Trim; 250 GPM / 946 l/min
C821K-24-40	3 in. NPT; Regulator; Internal Valve; Tee Body; with Kalrez® Trim; 400 GPM / 1514 l/min
C821T-16-10	2 in. NPT; Regulator; Internal Valve; Tee Body; with Teflon® Trim; 100 GPM / 379 l/min
C821T-16-25	2 in. NPT; Regulator; Internal Valve; Tee Body; with Teflon® Trim; 250 GPM / 946 l/min
C821T-24-25	3 in. NPT; Regulator; Internal Valve; Tee Body; with Teflon® Trim; 250 GPM / 946 l/min
C821T-24-40	3 in. NPT; Regulator; Internal Valve; Tee Body; with Teflon® Trim; 400 GPM / 1514 l/min
C821V-16-10	2 in. NPT; Regulator; Internal Valve; Tee Body; with Viton® Trim; 100 GPM / 379 l/min
C827E-16-25	2 in. NPT; Regulator; Internal Valve; Straight-Through Body; with Ethylene Propylene Trim; 250 GPM / 946 l/min

Type No.	Description
C827E-24-25	3 in. NPT; Regulator; Internal Valve; Straight-Through Body; with Ethylene Propylene Trim; 250 GPM / 946 l/min
C827K-16-10	2 in. NPT; Regulator; Internal Valve; Straight-Through Body; with Kalrez® Trim; 100 GPM / 379 l/min
C827K-16-15	2 in. NPT; Regulator; Internal Valve; Straight-Through Body; with Kalrez® Trim; 150 GPM / 568 l/min
C827K-16-25	2 in. NPT; Regulator; Internal Valve; Straight-Through Body; with Kalrez® Trim; 250 GPM / 946 l/min
C827K-24-25	3 in. NPT; Regulator; Internal Valve; Straight-Through Body; with Kalrez® Trim; 250 GPM / 946 l/min
C827K-24-40	3 in. NPT; Regulator; Internal Valve; Straight-Through Body; with Kalrez® Trim; 400 GPM / 1514 l/min
C827K-24-50	3 in. NPT; Regulator; Internal Valve; Straight-Through Body; with Kalrez® Trim; 500 GPM / 1893 l/min
C827N-16-15	2 in. Internal Valve with Neoprene (CR) Trim
C827N-24-15	3 in. NPT; Regulator; Internal Valve; Straight-Through Body; with Neoprene (CR) Trim; 150 GPM / 568 l/min
C827N-24-25	3 in. NPT; Regulator; Internal Valve; Straight-Through Body; with Neoprene (CR) Trim; 250 GPM / 946 l/min
C827N-24-40	3 in. NPT; Regulator; Internal Valve; Straight-Through Body; with Neoprene (CR) Trim; 400 GPM / 1514 l/min
C827T-16-10	2 in. NPT; Regulator; Internal Valve; Straight-Through Body; with Teflon® Trim; 100 GPM / 379 l/min
C827T-16-15	2 in. NPT; Regulator; Internal Valve; Straight-Through Body; with Teflon® Trim; 150 GPM / 568 l/min
C827T-16-25	2 in. NPT; Regulator; Internal Valve; Straight-Through Body; with Teflon® Trim; 250 GPM / 946 l/min
C827T-24-15	3 in. NPT; Regulator; Internal Valve; Straight-Through Body; with Teflon® Trim; 150 GPM / 568 l/min
C827T-24-20	3 in. NPT; Regulator; Internal Valve; Straight-Through Body; with Teflon® Trim; 200 GPM / 757 l/min
C827T-24-25	3 in. NPT; Regulator; Internal Valve; Straight-Through Body; with Teflon® Trim; 250 GPM / 946 l/min
C827T-24-40	3 in. NPT; Regulator; Internal Valve; Straight-Through Body; with Teflon® Trim; 400 GPM / 1514 l/min
C827T-24-50	3 in. NPT; Regulator; Internal Valve; Straight-Through Body; with Teflon® Trim; 500 GPM / 1893 l/min
C827V-16-15	2 in. NPT; Regulator; Internal Valve; Straight-Through Body; with Viton® Trim; 150 GPM / 568 l/min
C827V-16-25	2 in. NPT; Regulator; Internal Valve; Straight-Through Body; with Viton® Trim; 250 GPM / 946 l/min
C827V-24-25	3 in. NPT; Regulator; Internal Valve; Straight-Through Body; with Viton® Trim; 250 GPM / 946 l/min
C827V-24-40	3 in. NPT; Regulator; Internal Valve; Straight-Through Body; with Viton® Trim; 400 GPM / 1514 l/min
C827V-24-50	3 in. NPT; Regulator; Internal Valve; Straight-Through Body; with Viton® Trim; 500 GPM / 1893 l/min
C871K-16-25	2 in. NPT Internal Valve; Tee Body; Non-UL; 250 GPM / 946 l/min Spring; with FFKM Trim
C871K-24-37	3 in. NPT Internal Valve; Tee Body; Non-UL; 375 GPM / 1419 l/min Spring; with FFKM Trim
C871T-16-10	2 in. NPT Internal Valve; Tee Body; Non-UL; 105 GPM / 397 l/min Spring; with TFE Trim
C871T-16-25	2 in. NPT Internal Valve; Tee Body; Non-UL; 250 GPM / 946 l/min Spring; with TFE Trim
C871T-24-26	3 in. NPT Internal Valve; Tee Body; Non-UL; 265 GPM / 1003 l/min Spring; with TFE Trim
C871T-24-37	3 in. NPT Internal Valve; Tee Body; Non-UL; 375 GPM / 1419 l/min Spring; with TFE Trim
C871V-16-10	2 in. NPT Internal Valve; Tee Body; Non-UL; 105 GPM / 397 l/min Spring; with Fluorocarbon (FKM) Trim

BS&T - Internal Valves (continued)

Type No.	Description
C871V-16-15	2 in. NPT Internal Valve; Tee Body; Non-UL*; 150 GPM / 568 l/min Spring; with Fluorocarbon (FKM) Trim
C871V-16-25	2 in. NPT Internal Valve; Tee Body; Non-UL; 250 GPM / 946 l/min Spring; with Fluorocarbon (FKM) Trim
C871V-24-16	3 in. NPT Internal Valve; Tee Body; Non-UL; 160 GPM / 606 l/min Spring; with Fluorocarbon (FKM) Trim
C871V-24-26	3 in. NPT Internal Valve; Tee Body; Non-UL; 265 GPM / 1003 l/min Spring; with Fluorocarbon (FKM) Trim
C871V-24-37	3 in. NPT Internal Valve; Tee Body; Non-UL; 375 GPM / 1419 l/min Spring; with Fluorocarbon (FKM) Trim
C871V-24-46	3 in. NPT Internal Valve; Tee Body; Non-UL; 460 GPM / 1741 l/min Spring; with Fluorocarbon (FKM) Trim
C877K-16-10	2 in. NPT Internal Valve; Straight-Through Body; Non-UL; 105 GPM / 397 l/min Spring; with FFKM Trim
C877K-16-15	2 in. NPT Internal Valve; Straight-Through Body; Non-UL; 150 GPM / 568 l/min Spring; with FFKM Trim
C877K-16-25	2 in. NPT Internal Valve; Straight-Through Body; Non-UL; 250 GPM / 946 l/min Spring; with FFKM Trim
C877K-24-26	3 in. NPT Internal Valve; Straight-Through Body; Non-UL; 265 GPM / 1003 l/min Spring; with FFKM Trim
C877K-24-37	3 in. NPT Internal Valve; Straight-Through Body; Non-UL; 375 GPM / 1419 l/min Spring; with FFKM Trim
C877K-24-46	3 in. NPT Internal Valve; Straight-Through Body; Non-UL; 460 GPM / 1741 l/min Spring; with FFKM Trim
C877T-16-10	2 in. NPT Internal Valve; Straight-Through Body; Non-UL; 105 GPM / 397 l/min Spring; with TFE Trim
C877T-16-15	2 in. NPT Internal Valve; Straight-Through Body; Non-UL; 150 GPM / 568 l/min Spring; with TFE Trim
C877T-16-25	2 in. NPT Internal Valve; Straight-Through Body; Non-UL; 250 GPM / 946 l/min Spring; with TFE Trim
C877T-24-16	3 in. NPT Internal Valve; Straight-Through Body; Non-UL; 160 GPM / 606 l/min Spring; with TFE Trim
C877T-24-26	3 in. NPT Internal Valve; Straight-Through Body; Non-UL; 265 GPM / 1003 l/min Spring; with TFE Trim
C877T-24-37	3 in. NPT Internal Valve; Straight-Through Body; Non-UL; 375 GPM / 1419 l/min Spring; with TFE Trim
C877T-24-46	3 in. NPT Internal Valve; Straight-Through Body; Non-UL; 460 GPM / 1741 l/min Spring; with TFE Trim
C877V-16-25	2 in. NPT Internal Valve; Straight-Through Body; Non-UL; 250 GPM / 946 l/min Spring; with Fluorocarbon (FKM) Trim
C877V-24-26	3 in. NPT Internal Valve; Straight-Through Body; Non-UL; 265 GPM / 1003 l/min Spring; with Fluorocarbon (FKM) Trim
C877V-24-37	3 in. NPT Internal Valve; Straight-Through Body; Non-UL; 375 GPM / 1419 l/min Spring; with Fluorocarbon (FKM) Trim
C877V-24-46	3 in. NPT Internal Valve; Straight-Through Body; Non-UL; 460 GPM / 1741 l/min Spring; with Fluorocarbon (FKM) Trim
C884-24-16	3 in. Internal Valve; 160 GPM / 606 l/min Spring
C884-24-25	3 in. Internal Valve; 250 GPM / 946 l/min Spring
C884-24-40	3 in. Internal Valve; 400 GPM / 1514 l/min Spring
C884-24-50	3 in. Single Flange Internal Valve ~ Non-UL; 500 GPM / 1893 l/min
C884K-24-16	3 in. Flange Internal Valve; Single Flange Body; Non-UL; 160 GPM / 606 l/min Spring; with FFKM Trim
C884K-24-25	3 in. Flange Internal Valve; Single Flange Body; Non-UL; 250 GPM / 946 l/min Spring; with FFKM Trim
C884K-24-40	3 in. Flange Internal Valve; Single Flange Body; Non-UL; 400 GPM / 1514 l/min Spring; with FFKM Trim
C884N-24-40	3 in. Flange Internal Valve; Single Flange Body; Non-UL; 400 GPM / 1514 l/min Spring; with Neoprene (CR) Trim
C884T-24-16	3 in. Flange Internal Valve; Single Flange Body; Non-UL; 160 GPM / 606 l/min Spring; with TFE Trim

Type No.	Description
C884T-24-25	3 in. Flange Internal Valve; Single Flange Body; Non-UL; 250 GPM / 946 l/min Spring; with TFE Trim
C884T-24-40	3 in. Flange Internal Valve; Single Flange Body; Non-UL; 400 GPM / 1514 l/min Spring; with TFE Trim
C884V-24-16	3 in. Flange Internal Valve; Single Flange Body; Non-UL; 160 GPM / 606 l/min Spring; with Fluorocarbon (FKM) Trim
C884V-24-25	3 in. Flange Internal Valve; Single Flange Body; Non-UL; 250 GPM / 946 l/min Spring; with Fluorocarbon (FKM) Trim
C884V-24-40	3 in. Flange Internal Valve; Single Flange Body; Non-UL; 400 GPM / 1514 l/min Spring; with Fluorocarbon (FKM) Trim
C886K-24-16	3 in. CL300 Flange Inlet x FNPT Outlet; Non-UL; 160 GPM / 606 l/min Spring; with FFKM Trim
C886K-24-26	3 in. CL 300 Flange Inlet x FNPT Outlet; Non-UL; 265 GPM / 1003 l/min Spring; with FFKM Trim
C886K-24-37	3 in. CL300 Flange Inlet x FNPT Outlet; Non-UL; 375 GPM / 1419 l/min Spring; with FFKM Trim
C886K-24-46	3 in. CL300 Flange Inlet x FNPT Outlet; Non-UL; 460 GPM / 1741 l/min Spring; with FFKM Trim
C886N-24-16	3 in. CL300 Flange Inlet x FNPT Outlet; Non-UL; 160 GPM / 606 l/min Spring; with Neoprene (CR) Trim
C886N-24-26	3 in. CL300 Flange Inlet x FNPT Outlet; Non-UL; 265 GPM / 1003 l/min Spring; with Neoprene (CR) Trim
C886N-24-37	3 in. CL300 Flange Inlet x FNPT Outlet; Non-UL; 375 GPM / 1419 l/min Spring; with Neoprene (CR) Trim
C886N-24-46	3 in. CL300 Flange Inlet x FNPT Outlet; Non-UL; 460 GPM / 1741 l/min Spring; with Neoprene (CR) Trim
C887K-16-25	2 in. Internal Valve; 250 GPM / 946 l/min Spring
C887N-16-15	2 in. Internal Valve; 150 GPM / 568 l/min Spring
C887N-16-25	2 in. Internal Valve; 250 GPM / 946 l/min Spring
C887T-16-15	2 in. Internal Valve; 150 GPM / 568 l/min Spring
C887T-16-25	2 in. Internal Valve; 250 GPM / 946 l/min Spring
C887V-16-15	2 in. Internal Valve; 150 GPM / 568 l/min Spring
C887V-16-25	2 in. Internal Valve; 250 GPM / 946 l/min Spring
C891-16-10	2 in. Flange Internal Valve; Stainless Steel Side Outlet Body; Non-UL; 105 GPM / 397 l/min Spring; with Nitrile (NBR) Trim
C891-16-15	2 in. Flange Internal Valve; Stainless Steel Side Outlet Body; Non-UL; 150 GPM / 568 l/min Spring; with Nitrile (NBR) Trim
C891-16-25	2 in. Flange Internal Valve; Stainless Steel Side Outlet Body; Non-UL; 250 GPM / 946 l/min Spring; with Nitrile (NBR) Trim
C891-24-15	3 in. Flange Internal Valve; Stainless Steel Side Outlet Body; Non-UL; 150 GPM / 568 l/min Spring; with Nitrile (NBR) Trim
C891-24-26	3 in. Flange Internal Valve; Stainless Steel Side Outlet Body; Non-UL; 265 GPM / 1003 l/min Spring; with Nitrile (NBR) Trim
C891-24-40	3 in. Flange Internal Valve; Stainless Steel Side Outlet Body; Non-UL; 400 GPM / 1514 l/min Spring; with Nitrile (NBR) Trim
C891SN-16-15	2 in. Flange Internal Valve; Stainless Steel Side Outlet Body; Non-UL; 150 GPM / 568 l/min Spring; with Neoprene (CR) Trim
C891SN-24-16	3 in. Flange Internal Valve; Stainless Steel Side Outlet Body; Non-UL; 160 GPM / 606 l/min Spring; with Neoprene (CR) Trim
C891SN-24-26	3 in. Flange Internal Valve; Stainless Steel Side Outlet Body; Non-UL; 265 GPM / 1003 l/min Spring; with Neoprene (CR) Trim
C891ST16-15	2 in. Flange Internal Valve; Stainless Steel Side Outlet Body; Non-UL; 150 GPM / 568 l/min Spring; with TFE Trim
C891ST16-25	2 in. Flange Internal Valve; Stainless Steel Side Outlet Body; Non-UL; 250 GPM / 946 l/min Spring; with TFE Trim
C891ST24-26	3 in. Flange Internal Valve; Stainless Steel Side Outlet Body; Non-UL; 265 GPM / 1003 l/min Spring; with TFE Trim
C891T-16-25	2 in. Internal Valve; 250 GPM / 946 l/min Spring
C897T-16-15	2 in. Internal Valve; SST/STL; 150 GPM / 568 l/min
C897T-16-25	2 in. Internal Valve; 250 GPM / 946 l/min

### BS&T - Back Check Valves

Type No.	Description
G100	3/4 in. MNPT x 3/4 in. FNPT; Back Pressure Valve; Brass; 21 GPM / 79 l/min
G101	1-1/4 in MNPT x 1-1/4 in. FNPT; Back Pressure Valve; Brass; 55 GPM / 208 l/min
G102	2 in. MNPT x 2 in. FNPT; Back Pressure Valve; Brass; 150 GPM / 568 l/min
G104	3 in. MNPT x 3 in. FNPT; Back Pressure Valve; Steel; 250 GPM / 946 l/min
G105	2 x 2 in. MNPT and 1-1/4 in. FNPT; Back Pressure Valve; Steel; Soft Seat
G106	3 in. FNPT x 2 in. MNPT; Back Pressure Valve; Steel; Soft Seat; 254 GPM / 961 l/min
G107	3 x 3 in. MNPT and 2 in. MNPT; Back Pressure Valve; Steel; Soft Seat; 254 GPM / 961 l/min
G109	2 x 2 in. FNPT; Back Pressure Valve; In-Line; Brass; 150 GPM / 568 l/min
G112	2 in. MNPT x 2 in. FNPT; Back Pressure Valve; Steel; 150 GPM / 568 l/min
G200-10	1-1/4 x 1-1/4 in. FNPT; Back Pressure Valve; Ductile Iron; 190 GPM / 719 l/min
G200-16	2 x 2 in. FNPT; Back Pressure Valve; Ductile Iron; 350 GPM / 1325 l/min
G200-24	3 x 3 in. FNPT; Back Pressure Valve; Ductile Iron; 800 GPM / 3028 l/min
G201-10	1-1/4 in. Back Pressure Valve; with Flow Indicator
G201-16	2 in. Back Pressure Valve; with Flow Indicator
G201-24	3 in. Back Pressure Valve; with Flow Indicator

### BS&T ESV - Emergency Shutoff Valves

Type No.	Description
N551-10	1-1/4 in. Emergency Shutoff Valve, UL®
N551-16	2 in. Emergency Shutoff Valve, UL
N551-24	3 in. Emergency Shutoff Valve, UL
N562-16	Railcar valve with 2 in. FNPT Outlet
N562-18	Railcar valve with 2-1/4 in. Male ACME Outlet
N562-26	Railcar valve with 3-1/4 in. Male ACME Outlet
N562-REPAIR	Railcar Repair
N563-16	Railcar valve with 2 in. FNPT Outlet and 2 in. FNPT Nipple; UL; Nitrile (NBR)
N563-26	Railcar valve with 3-1/4 in. ACME Outlet and 2 in. FNPT Nipple; UL; Nitrile (NBR)
N851K-10	1-1/4 in. Emergency Shutoff Valve, Non-UL, Kalrez® Trim
N851K-16	2 in. Emergency Shutoff Valve, Non-UL, Kalrez® Trim
N851K-24	3 in. Emergency Shutoff Valve, Non-UL, Kalrez® Trim
N862K-16	Railcar valve with 2 in. FNPT Outlet; with FFKM Trim
N862K-18	Railcar valve with 2-1/4 in. Male ACME Outlet; with FFKM Trim
N862K-26	Railcar valve with 3-1/4 in. Male ACME Outlet; with FFKM Trim
N862V-16	Railcar valve with 2 in. FNPT Outlet; with Fluorocarbon (FKM) Trim
N862V-18	Railcar valve with 2-1/4 in. Male ACME Outlet; with Fluorocarbon (FKM) Trim
N862V-26	Railcar valve with 3-1/4 in. Male ACME Outlet; with Fluorocarbon (FKM) Trim
N863-16	Railcar valve with 2 in. FNPT Outlet and 2 in. FNPT Nipple; Nitrile (NBR)

### BS&T ESV - Emergency Shutoff Valves (continued)

Type No.	Description
N863-26	Railcar valve with 3-1/4 in. ACME Outlet and 2 in. FNPT Nipple; Nitrile (NBR)
N863E-16	Railcar valve with 2 in. FNPT Outlet and 2 in. FNPT Nipple; Ethylene Propylene
N863E-26	Railcar valve with 3-1/4 in. ACME Outlet and 2 in. FNPT Nipple; Ethylene Propylene
N863K-16	Railcar valve with 2 in. FNPT Outlet and 2 in. FNPT Nipple; Kalrez®
N863K-26	Railcar valve with 1/4 in. ACME Outlet and 2 in. FNPT Nipple; Kalrez®
N863N-16	Railcar valve with 2 in. FNPT Outlet and 2 in. FNPT Nipple; Neoprene (CR)
N863N-26	Railcar valve with 3-1/4 in. ACME Outlet and 2 in. FNPT Nipple; Neoprene (CR)
N863T-16	Railcar valve with 2 in. FNPT Outlet and 2 in. FNPT Nipple; TFE
N863T-26	Railcar valve with 3-1/4 in. ACME Outlet and 2 in. FNPT Nipple; TFE
N863V-16	Railcar valve with 2 in. FNPT Outlet and 2 in. FNPT Nipple; Viton®
N863V-26	Railcar valve with 3-1/4 in. ACME Outlet and 2 in. FNPT Nipple; Viton®

### BS&T - Globe and Angle Valves

Type No.	Description
N301-04	1/2 in. NPT Globe Valve
N301-06	3/4 in. NPT Globe Valve
N301-08	1 in. NPT Globe Valve
N310-10	1-1/4 in. NPT Globe Valve
N310-12	1-1/2 in. NPT Globe Valve
N310-16	2 in. NPT Globe Valve
N310-24	3 in. NPT Globe Valve
N310F-24	3 in. ASME Flange Globe Valve
N350-04	1/2 in. Economy Globe Valve
N350-06	3/4 in. Economy Globe Valve
N401-04	1/2 in. NPT Angle Valve
N401-06	3/4 in. NPT Angle Valve
N401-08	1 in. NPT Angle Valve
N410-10	1-1/4 in. NPT Angle Valve
N410-12	1-1/2 in. NPT Angle Valve
N410-16	2 in. NPT Angle Valve
N410-24	3 in. NPT Angle Valve
N410F-24	3 in. ASME Flange Angle Valve
N450-04	1/2 in. Economy Angle Valve
N450-06	3/4 in. Economy Angle Valve
N801T-04	1/2 in. NPT Globe Valve; with TFE Trim
N801T-06	3/4 in. NPT Globe Valve; with TFE Trim
N801T-08	1 in. NPT Globe Valve; with TFE Trim
N810FT-24	3 in. ASME Flange Globe Valve; with TFE Trim
N810T-10	1-1/4 in. NPT Globe Valve; with TFE Trim

**BS&T - Globe and Angle Valves (continued)**

Type No.	Description
N810T-12	1-1/2 in. NPT Globe Valve; with TFE Trim
N810T-16	2 in. NPT Globe Valve; with TFE Trim
N810T-24	3 in. NPT Globe Valve; with TFE Trim
N901T-04	1/2 in. NPT Angle Valve; with TFE Trim
N901T-06	3/4 in. NPT Angle Valve; with TFE Trim
N901T-08	1 in. NPT Angle Valve; with TFE Trim
N910FT-24	3 in. ASME Angle Globe Valve; with TFE Trim
N910T-10	1-1/4 in. NPT Angle Valve; with TFE Trim
N910T-12	1-1/2 in. NPT Angle Valve; with TFE Trim
N910T-16	2 in. NPT Angle Valve; with TFE Trim
N910T-24	3 in. NPT Angle Valve; with TFE Trim

**BS&T - Additional Valves**

Type No.	Description
D138	Fill Valve; 2 X 2-1/4 in.; Single Check
D139	3 in. MNPT X 3-1/4 in. ACME; Fill Valve; Single Check
D140	2 in. MNPT X 2-1/4 in. ACME; Fill Valve; Double Check
D141	3 in. MNPT X 3-1/4 in. ACME; Fill Valve; Double Check
F100	3/4 in. MNPT x 3/4 in. FNPT; Excess Flow Valve; 8.4 GPM / 32 l/min
F101	3/4 in. MNPT X 3/4 in. FNPT; Excess Flow Valve; 20 GPM / 76 l/min
F102	1-1/4 in. MNPT X 1-1/4 in. FNPT; Excess Flow Valve; 33 GPM / 125 l/min
F105	1-1/4 in. MNPT X 1-1/4 in. FNPT; Excess Flow Valve; 55 GPM / 208 l/min
F106	2 in. MNPT X 2 in. FNPT; Excess Flow Valve; 85 GPM / 322 l/min
F107	2 in. MNPT X 2 in. FNPT; Excess Flow Valve; 100 GPM / 379 l/min
F110	Excess Flow POL X 9/16 in.; 204 SCFH / 5.5 Nm <sup>3</sup> /h
F110A	Soft Nose MPOL X 9/16 in. to 18 in UNF LH; 204 SCFH / 5.5 Nm <sup>3</sup> /h
F110AW	Soft Nose MPOL X 9/16 in. to 18 in. UNF LH with Wing Nuts (T20582)
F110LP	MPOL X 9/16 in. to 18 in. UNF LH; 204 SCFH
F130	1 X 1 in. FNPT; Excess Flow Valve; 25 GPM / 95 l/min
F131	1-1/2 X 1-1/2 in. FNPT; Excess Flow Valve; 60 GPM / 227 l/min
F132	2 X 2 in. FNPT; Excess Flow Valve; 95 GPM / 360 l/min
F133	2 X 2 in. FNPT; Excess Flow Valve; 155 GPM / 587 l/min

**BS&T - Additional Valves (continued)**

Type No.	Description
F134	1-1/2 in. MNPT X 1 in. FNPT X 1 in. FNPT; Excess Flow Valve; 28 GPM / 106 l/min
F135	2-1/2 in. MNPT X 1-1/2 in. FNPT X 1-1/2 in. FNPT; Excess Flow Valve; 60 GPM / 227 l/min
F138	Excess Flow; 1/4 X 1/4 in.; 641 SCFH / 17 Nm <sup>3</sup> /h
F170	Excess Flow; 3/4 X 3/4 in.; 6.6 GPM
F173	Excess Flow; MPOL X 1/4; 204 SCFH / 5.5 Nm <sup>3</sup> /h
F173A	Excess Flow; Soft POL X 1/4 in.; 204 SCFH / 5.5 Nm <sup>3</sup> /h
F173AW	Excess Flow; Soft POL and Wing Nut
F181	Excess Flow; MPOL X 1/4 in.; 570 SCFH / 15 Nm <sup>3</sup> /h
F183	Excess Flow; MPOL X 9/16 in.; 570 SCFH / 15 Nm <sup>3</sup> /h
F186-06-1	Excess Flow-Air; 3/4 X 3/4; 171 SCFM / 275 Nm <sup>3</sup> /h
F187-08-1	Excess Flow-Air; 1 X 1; 189 SCFM / 304 Nm <sup>3</sup> /h
F187-12-1	Excess Flow-Air; 1.5 X 1.5; 416 SCFM / 669 Nm <sup>3</sup> /h
F187-16-1	2 X 2 in. FNPT; Excess Flow Valve; Air; 879 SCFM / 1413 Nm <sup>3</sup> /h
F188-24-1	3 in. MNPT X 3 X 2 in. NPT; Excess Flow Valve; Air; 1729 SCFM / 2780 Nm <sup>3</sup> /h
F190	2 X 2 in. MNPT X 1-1/4 in. FNPT; Excess Flow Valve; Steel; 80 GPM / 303 l/min
F191	2 X 2 in. MNPT X 1-1/4 in. FNPT; Excess Flow Valve; Steel; 105 GPM / 397 l/min
F194	3 X 2 in. MNPT; Excess Flow Valve; Steel; 165 GPM / 625 l/min
F195	3 X 2 in. MNPT; Excess Flow Valve; Steel; 260 GPM / 984 l/min
F198	3 X 3 in. MNPT X 2 in. FNPT; Excess Flow Valve; Steel; 165 GPM / 625 l/min
F199	3 X 3 in. MNPT X 2 in. FNPT; Excess Flow Valve; Steel; 260 GPM / 984 l/min
F202	MPOL X 1/2 in. SAE Flare; Excess Flow Valve; 1100 SCFH / 29 Nm <sup>3</sup> /h
N201	Cylinder Filling Valve
N201-CFHA	Cylinder Filling Valve Hose Assembly
N456	Liquid Transfer Valve; 3/4 in. MNPT x 1-3/4 in. ACME
N480	1 in. NPT Hose End Valve; with M570 Adaptor
N481	1 in. NPT Hose End Valve Only

### Regulator Accessories

Type No.	Description
50-2	1/4 in. MNPT; Test Gage; 0 to 35 in. w.c. / 0 to 0.09 mbar
50P-2	Test Gage Kit; Hose and Case
50P-5	Test Gage and Hose
803/21	Service Indicator; For Regulator 966
J500	Pressure Gauge; 0 to 15 psi; Back Connection
J501	Pressure Gauge; 0 to 30 psi; Back Connection
J502	Pressure Gauge; 0 to 60 psi; Back Connection
J504	Pressure Gauge; 0 to 160 psi; Back Connection
J506	Pressure Gauge; 0 to 300 psi; Back Connection
J514	Pressure Gauge; 0 to 160 psi; Back Connection
J516	Pressure Gauge; 0 to 300 psi; Back Connection
J542	Pressure Gauge; 0 to 400 psi; Steel
P100A	Triangular Mounting Bracket for R Series
P100C	Bowtie Mounting Bracket for R Series
P102A	Strap Bracket for 912 Series
P499	1/4 in. Flare X 1/4 in. MNPT Adaptor
P500	1/4 in. Inverted Flare Male Plug
P501	Filter for 67 Series Regulator

Type No.	Description
P520L	Orifice Reamer
P593-1	Aluminum Body Filter
P594-1	Brass Body Filter
Y602-1	Umbrella Vent; 1/4 in. MNPT
Y602-10	Vent Assembly
Y602-11	Vent Assemblies
Y602-12	S303 Vent Assembly
Y602-13	Angle Vent; 1/4 in. FNPT
Y602-14	Angle Vent; 1/4 in. FNPT; With Stabilizer
Y602-2	Umbrella Vent; 1/4 in. MNPT; With Stabilizer
Y602-23	Angle Vent; 3/4 in. MNPT
Y602-25	Angle Vent; 1 in. MNPT
Y602-5	Angle Vent; 3/8 in. FNPT
Y602-6	Angle Vent; 3/8 in. FNPT; With Stabilizer
Y602-7	Angle Vent; 1/2 in. FNPT
Y602-8	Angle Vent; 1/2 in. FNPT; With Stabilizer
Y602-9	Angle Vent; 3/4 in. FNPT

### BS&T - Accessories

Type No.	Description
J31A-1	Rotary Gauge
J31A-2	Rotary Gauge
J31A-3	Rotary Gauge
J31A-3L	Rotary Gauge
J31L-1	Rotary Gauge; 68 in.; Over 1200 Dial
J31L-2	Rotary Gauge; 69 to 92 in.; Over 1200 Dial
J31L-3	Rotary Gauge; 93 to 108 in.; Over 1200 Dial
J31L-3L	Rotary Gauge; 109 to 140 in.; Over 1200 Dial
J31X-1	X=No Dial
J31X-2	Less Dial
J31X-3L	Gauge
J402S	Liquid Vent Valve; 1/4 in.; SST
J403S	Liquid Vent; 1/4 in.; Stop Dial; SST
J415	Lever Gauge; 3/4 in.; Steel
J415-1	Liquid Level Vent Valve
J415-2	Angle Valve
J700	Thermometer; 1/2 in.; 4 in. Stem; Steel
J701	Thermometer; 1/2 in.; 6 in. Stem; Steel
J702S	Thermometer; 1/2 in. MNPT, 2 in. / 51 mm dial, 3 in. / 76 mm stem, -80 to 120°F / -60 to 50°C
M100	Coupling; 1-1/4 in. FACME X 3/8 MNPT
M101	Coupling; 1-1/4 in. FACME X 1/2 MNPT
M108	CAP; 1-1/4 in. FACME
M109	CAP; 1-3/4 in. FACME
M109-1	M109 with Type P147 Attached
M110	Coupling; 1-3/4 in. FACME X 1/2 MNPT
M111	Coupling; 1-3/4 in. FACME X 3/4 MNPT
M112	Coupling; 1-3/4 in. FACME X 1 MNPT
M120	Coupling; 2-1/4 in. FACME X 1-1/4 MNPT
M121	Coupling; 2-1/4 X 1-1/4 in.; Steel
M130	Coupling; 3-1/4 in. FACME X 2 MNPT
M133	Coupling; 3-1/4 X 2 in. NPT; Steel

Type No.	Description
M140	Coupling; 1-1/4 in. FACME X 3/8 in. MNPT
M141	Coupling; 1-1/4 in. FACME X 1/2 MNPT
M150	Coupling; 1-3/4 in. FACME X 3/4 MNPT
M151	Coupling; 1-3/4 in. FACME X 1 MNPT
M160	Coupling; 2-1/4 in. FACME X 1-1/4 MNPT
M178	Dust Seal; 1-1/4 in. MACME; Plastic
M179	Dust Seal; 1-3/4 in. MACME; Plastic
M180	Dust Seal; 2-1/4 in. MACME; Plastic
M181	Dust Seal; 3-1/4 in. MACME; Plastic
M192	Adaptor; 1-1/4 in. MACME X 1/2 FNPT
M193	Adaptor; 1-1/4 in. MACME X 3/4 FNPT
M211	Adaptor; 1-3/4 in. MACME X 3/8 FNPT
M219	CAP; 1-3/4 in. FACME; Steel
M219-1	CAP; 1-3/4 in. ACME; Steel; with Type P147
M229	1-3/4 in. Brass Female Cap
M229-1	Brass CAP and Chain Assembly
M239	1-3/4 in. MACME Dust Plug
M284	Adaptor; FPOL X 1/4 MNPT
M285	Adaptor; FPOL X 3/8 MNPT
M286	Adaptor; FPOL X 1/2 MNPT
M287	Adaptor; FPOL X 3/4 MNPT
M301	Adaptor; FPOL X 1/4 FNPT
M303	Adaptor; FPOL X 1/2 FNPT
M306	Adaptor; CGA 1550 X 1/4 MNPT
M307	Adaptor; CGA 1550 X 9/16 VNF-LH
M3162-08	Clamp Hose Coupling; 1/2 in. MNPT
M3162-12	Clamp Hose Coupling; 3/4 in. MNPT
M3162-12S	Clamp Hose Coupling; 1-3/4 in. FACME
M3162-16	Clamp Hose Coupling; 1 in. MNPT
M3162-20	Clamp Hose Coupling; 1-1/4 in. MNPT

### BS&T - Accessories (continued)

Type No.	Description
M3162-24	Clamp Hose Coupling; 1-1/2 in. MNPT
M3162-32	Clamp Hose Coupling; 2 in. MNPT
M3162-32B	Clamp Hose Coupling; 3-1/4 in.; Brass
M3162-32S	Clamp Hose Coupling; 3-1/4 in.; Steel
M3162-48	Clamp Hose Coupling; 3 MNPT
M3162-48B	Clamp Hose Coupling; 4-1/4 in.; Brass
M3162-48S	Clamp Hose Coupling; 4-1/4 in.; Steel
M357	Adaptor; MPOL X 1/2 FNPT
M388	Coupling; Soft MPOL X 1/4 MNPT
M390	Coupling; Soft POL X 1/4 NPT; 6 in.
M420	Seal Cap; FPOL
M431	Seal Cap; 2-1/4 in. FACME
M432	Seal Cap; 2-1/4 in. FACME; Steel
M441	M441 Seal Cap; 3-1/4 in. FACME
M442	Adaptor; 3-1/4 ACME X 1-1/4 in. NPT
M443	Seal Cap; 3-1/4 in. FACME; Steel
M450A	Unload Adaptor; 1-3/4 ACME X 3/4 in. NPT
M455	Adaptor; 3/4 X 3/4 in.; For Type N456
M498-4-2	Adaptor; 1-1/4 ACME X 1/2 in. NPT
M498-6-3	Adaptor; 1-1/4 ACME X 3/4 and 3/8 in.
M535-34	Plug; 4-1/4 in. MACME; Steel
M570	Hose Adaptor; 1-3/4 X 1-3/4 in. ACME
M605-34	Seal cap; 4-1/4 in. FACME
M611	Adaptor; 2-1/4 X 1-3/4 in. ACME
M612	Adaptor; 3-1/4 X 1-3/4 in. ACME
M613	Adaptor; 4-1/4 X 3-1/4 in. ACME
M622	Adaptor; 3-1/4 X 1-3/4 in.; Steel
M623	Adaptor; 4-1/4 X 3-1/4 in.; Steel
M625-34	Seal Cap; 4-1/4 in. FACME; Steel

Type No.	Description
M631-6	Coupling; 1-3/4 X 3/4 in. NPT Steel
M631-8	Coupling; 1-3/4 in. ACME X 1 in. NPT Steel
M634-24	Coupling; 4-1/4 ACME X 3 in. NPT; Steel
M635-6	Coupling; 1-3/4 ACME X 3/4 in.; Steel
M635-8	Coupling; 1-3/4 ACME X 1 in. NPT; Steel
M640-4	Coupling; 1-1/4 X 1/2 in. NPT; Steel
M641-8	Coupling; 1-3/4 ACME X 1 in. NPT; Steel
M646-6	Coupling; 1-3/4 X 3/4 in. NPT; Steel
M646-8	Coupling; 1-3/4 ACME X 1 in. NPT; Steel
M664-24	Coupling; 4-1/4 in. FACME X 3 MNPT
P104-24	Pipe-Away Adaptor for Type H284/H5114
P105	Deflector; 1/4 NPT; For Type H285
P120B	Spanner Wrench for ACME Fittings
P134	Fusible Links for Internal Valve Actuators
P145	Raincap for Types H185, H275 and 1805
P147	Chain and Ring for D101 and E102
P148	Chain and Ring for D200 and E125
P163A	Auxiliary Release; 25 ft. Cable; For 1-1/4, 2 and 3 in. Internal Valves
P164A	Auxiliary Release; 50 ft. Cable; For 1-1/4, 2 and 3 in. Internal Valves
P164B	Auxiliary Release; 50 ft. Cable; For Type N550/N551 ESV
P164C	Type P164B without Cable and Cable Casing
P167	Chain and Hook for ACME Caps
P174	1/2 in. FNPT Adaptor for Types H135 and H173
P183	Chain and Hook for 3-1/4 in. Seal
P193	Air Brake Kit; Under 3500 Gallons
P194	Air Brake Kit; Over 3500 Gallons
P195	Air Brake Kit; Twin Barrels
P205	Raincap for Type H348
P206	Raincap for Type H360/H369



### BS&T - Accessories (continued)

Type No.	Description
P209	Raincap for Type H250
P297	Raincap for Type H722/H822
P298	Raincap for Type H733/H833
P299	Raincap for Type H284/H5114
P304	Wrench for Type H722/H822
P305	Wrench for Type H733/H833
P306	Air Kit for transfer with 1 valve
P307	Air kit for transfer with 2 valves
P308	Air kit for transfer with 3 valves
P313	Lever and Release Assembly for Types C204-32, C404-32 and C404M32
P314	Cable Assembly for Types C204-32, C404-32 and C404M32
P315	Release Handle Used with Type P313 Includes 30 ft. Cable
P322	Gauge Dial; for 1200 Gallons or under
P323	Gauge Dial; for 1200 Gallons or over
P324	Gauge Dial; for NH <sub>3</sub> Service
P327D	Air Cylinder Latch Block for Type N550/N551 ESV
P340	Fusible Element Latch Assembly for 2 and 3 in. NPT Internal Valves
P341	Fusible Element Latch Assembly for 1-1/4 in. NPT Internal Valves
P341LP	Fuse Latch

Type No.	Description
P342	Bi-Directional Latch Assembly for 1-1/4 in. NPT Internal Valves
P389	Cylinder Style Air Actuator for 1-1/4 in. NPT Internal Valves
P539A	Brake Chamber Style Air Actuator for Type N550/N551 ESV
P551	External Closing Spring Kit for Type N550/N551 ESV with Cable Release Latch Block
P551A	External Closing Spring Kit for Type N550/N551 ESV with Type P327A Pneumatic Release Latch Block
P613	Brake Chamber Style Air Actuator for Types C404-24 and C484-24
P614A	Brake Chamber Style Air Actuator for Types C204-32 and C404-32
P623	Brake Chamber Style Air Actuator for Types C403-24 and C483-24
P631	Steel Enclosed Air Actuator for Type C407-10
P639	Air Actuator; Types C402, C421 and C427
P639A	Brake Chamber Style Air Actuator for 2 and 3 in. NPT Internals
P650	Primary Cable Control; 1-1/4, 2 and 3 in. Internal Valves
P651	Cable Control Only
P713	Rotary Actuator; Type P713; 3 in. Single Flange
P714	Rotary Actuator; Type P714; 4 in. Single Flange
P723	Rotary Actuator; Type P723; 3 in. Double Flange
P731	Rotary Actuator; Type P731; 1-1/4 in. Internal Valve
P739	Rotary Actuator; 2 and 3 in. NPT Internals

### Pilots

Type No.	Description
6351V-2	Type 6351 Pilot for Type 1098/1098H; 5 to 35 psig / 0.34 to 2.4 bar; Viton®
6358EBHLP	250 to 375 psig / 17.2 to 25.9 bar; Relief Valve Pilot Assembly; with Elbow
6358EBLP-1	85 to 140 psig / 5.9 to 9.7 bar; Relief Valve Pilot Assembly; with Elbow
6358EBLP-2	130 to 200 psig / 9 to 13.8 bar; Relief Valve Pilot Assembly; with Elbow
6358EBLP-250	UL® Listed Pilot; 250 psig / 17.2 bar setpoint
6358EBLP-3	180 to 350 psig / 12.4 to 24.1 bar; Relief Valve Pilot Assembly; with Elbow
99H-1	99 Series Pilot (Type 61H); 10 to 65 psi / 0.69 to 4.5 bar
99HP-1	99 Series Pilot (Type 61HP); 35 to 100 psi / 2.4 to 6.9 bar
99L-1	99 Series Pilot (Type 61L); 1/4 to 2 psi / 17 mbar to 0.14 bar
99L-2	99 Series Pilot (Type 61L); 1 to 5 psi / 69 mbar to 0.34 bar
99L-3	99 Series Pilot (Type 61L); 2 to 10 psi / 0.14 to 0.69 bar
99L-4	99 Series Pilot (Type 61L); 5 to 15 psi / 0.34 to 1 bar
99L-5	99 Series Pilot (Type 61L); 10 to 20 psi / 0.69 to 1.4 bar
XAPT6352002	Type 6352 Pilot for Type 1098 Regulator; 14 in. to 2 psig / 35 mbar to 0.14 bar
XAPT6352010	Type 6352 Pilot for Type 1098 Regulator; 2 to 10 psig / 0.14 to 0.69 bar
XAPT6352040	Type 6353 Pilot for Type 1098 Regulator; 3 to 40 psig / 0.21 to 2.8 bar
XAPT6352075	Type 6353 Pilot for Type 1098 Regulator; 35 to 125 psig / 2.4 to 8.6 bar

### Repair Kits - Regulators

Type No.	Description
R299X000012	Type 299 Spare Repair Kit
R61HHX00012	Type 61HH Neoprene (CR)/Diaphragm Nitrile (NBR)/Disc Repair Kit
R61HPX00022	Type 61HP Standard Repair Kit
R61HX000012	Type 61H Nitrile (NBR) Diaphragm/Disc Repair Kit
R61LDX00012	Type 61LD Nitrile (NBR) Diaphragm/Disc Repair Kit
R61LX000012	Type 61L Nitrile (NBR) Diaphragm/Disc Repair Kit
R627HX000512	Types 627H and 627HM SST/Nylon (PA) Trim Repair Kit
R627RX00A12	Types 627MR and 627R Aluminum/Nitrile (NBR) Trim Repair Kit
R627RX00A22	Types 627MR and 627R Aluminum/Nylon (PA) Trim Repair Kit

### Repair Kits - Regulators (continued)

Type No.	Description
R627RX000512	Types 627MR and 627R SST/Nitrile (NBR) Trim Repair Kit
R627RX000522	Types 627MR and 627R SST/Nylon (PA) Trim Repair Kit
R627X000A12	Types 627 and 627M Aluminum/Nitrile (NBR) Trim Repair Kit
R627X000A22	Types 627 and 627M Aluminum/Nylon (PA) Trim Repair Kit
R627X000512	Types 627 and 627M SST/Nitrile (NBR) Trim Repair Kit
R627X000522	Types 627 and 627M SST/Nylon (PA) Trim Repair Kit
R627X000V12	Types 627 Aluminum/Fluorocarbon (FKM) Trim Repair Kit
R630X000L12	Type 630 Low Pressure Brass Trim with Comp/Disc Repair Kit
R630X000L22	Type 630 Low Pressure Brass Trim with Nylon (PA)/Disc Repair Kit
R64RX000012	Type 64R Spring Range 3 to 150 Repair Kit
R64RX000H22	Type 64R Spring Range 130 to 200 Repair Kit
R64SRT00012	Type 64SR LPG Regulator Repair Kit
R64X0000012	Type 64 Spring Range 3 to 150 Repair Kit
R64X0000H22	Type 64 Spring Range 130 to 200 Repair Kit
R67CX000012	Type 67C Brass/Nitrile (NBR) Repair Kit
R99HPX00012	Type 99HP Comp Disc 7/8 in. Port Repair Kit
R99HPX00022	Type 99HP Comp Disc 1-1/8 in. Port Repair Kit
R99HX000012	Type 99H Comp Disc 7/8 in. Port Repair Kit
R99HX000022	Type 99H Comp Disc 1-1/8 in. Port Repair Kit
R99LX000012	Type 99L Comp Disc 7/8 in. Port Repair Kit
R99LX000022	Type 99L Comp Disc 1-1/8 in. Port Repair Kit
R99LX000032	Type 99 Vent Assembly Retrofit Repair Kit
RCS200X0012	Type CS200 Repair Kit
RCS400X0012	Types CS400, CS403 and CS404 Repair Kit
RCS403X0012	Type CS403 Repair Kit
RCS404X0012	Type CS404 Repair Kit
RCS800XBLK2	Type CS800 with Black Disc Repair Kit
RCS800XBLU2	Type CS800 with Blue Disc Repair Kit
RCS800XGRN2	Type CS800 with Green Disc Repair Kit
RS100X00012	Types S100 and S102 Spare Less Seat Repair Kit

### Repair Kits - Regulators (continued)

Type No.	Description
RS200XRT012	Type S200 Stabilizing Retrofit Repair Kit
RS201HX0012	Types S201H and S202H Spare Less Seat Repair Kit
RS201KX0012	Type S201K Spare Less Seat Repair Kit
RS201X00012	Types S201 and S202 Spare Less Seat Repair Kit
RS301FX0012	Types S301D and S301F Spare Less Seat Repair Kit
RS301PX0012	Type S301P, High Pressure and Type S302P; High Pressure Spare Less Seat Repair Kit
RS301X00012	Type S301, High Pressure; Type S302; High Pressure Spare Less Seat Repair Kit
RS400X00012	S400 Series Orifice Tube; 1/8 in. Repair Kit
RS400X00022	S400 Series Orifice Tube; 3/16 in. Repair Kit
RS400X00032	S400 Series Orifice Tube; 1/4 in. Repair Kit
R63EGLPX012	Repair kit for Type 63EGLP Main body

### Repair Kits - Valves (continued)

Type No.	Description
RCN551T0012	Type N551 Packing Repair Kit
RFC40432T12	Type C40432 Retro Fit Kit
RFC4716T012	2 in. NPT Type C471/C477 Jet Bleed Retro Fit Kit
RFC4724T012	3 in. NPT Type C471/C477 Jet Bleed Retro Fit Kit
RFC4824T012	3 in. Flange Type C483/C484 Jet Bleed Retro Fit Kit
RN30008T012	Type N300-8/N400-8 Nitrile (NBR) Trim Repair Kit
RN30012T012	Type N300-12/N400-12 Nitrile (NBR) Trim Repair Kit
RN30016T012	Type N300-16/N400-16 Nitrile (NBR) Trim Repair Kit
RN30024T012	Type N300/N400-24 Nitrile (NBR) Trim Repair Kit
RN350T00012	N350/N450 Series Nitrile (NBR) Trim Repair Kit
T12689T0012	N300/N400 Series Repair Kit; Bonnet, Packing and Stem Assembly
T13090T0012	Type N550 Packing Repair Kit
T11396000B2	Retrofitted Type C404-32 Packing Replacement Kit
T11396000C2	Type C404-32 Seals Replacement Parts Kit
T20377000B2	2 in. Types C421, C427, C471 and C477; Nitrile (NBR) Gland Assembly with Gland O-ring
T20430000B2	3 in. Types C421, C427, C471, C477, C483, C484 and C486 Nitrile (NBR) Gland Assembly with Gland O-ring

### Repair Kits - Valves

Type No.	Description
1P110799152	C404-32 Upper Spiral Wound Gasket
ERAA03396A0	C404-32 Retrofit Cable Pulley Kit
ERSA03240A0	C404-32 Lower Spiral Wound Gasket (Replaces T1118299152 and GA26077X032)
MK63EGLP001	Type 63EGLP Mounting Kit; Tank to Valve; Studs and Nuts
MK63EGLP002	Type 63EGLP Mounting Kit; Valve to Reducer; Bolts and Nuts
N56X-REPAIR	Contact your Fisher™ Distributor
R63EGLPX012	Repair kit for Type 63EGLP Main body
RC40016T012	2 in. Types C421 and C427 Repair Kit
RC40024T012	3 in. Types C421 and C427 Repair Kit
RC40324T012	3 in. Types C403-24 Repair Kit
RC40424T012	3 in. Types C404-24 Repair Kit
RC404YGT012	Types C404-32 Seal Replacement Parts Kit; Y Grade NGL
RC40710T012	Repair Kit for 1-1/4 in. Type C407-10
RC40710T032	Repair Kit Type C407-10, New Spring, Cam, with Gland Assembly, Seals, Nitrile (NBR)
RC40710T042	Type C407-10 Repair Kit, Main and Gland Seals, Cam and Spring
RC47016T012	2 NPT Types C471 and C477 Repair Kit
RC47024T012	3 NPT Types C471 and C477 Repair Kit
RC48324T012	Type C483 Repair Kit
RC48424T012	Type C484 Repair Kit

## WARRANTY AND LIABILITY

In consideration for the discount pricing offered above, the following terms and conditions are accepted by Distributor and shall apply to all products subject to this pricing sheet (“Goods”). Distributor shall extend these limited warranty and limitation of liability provisions, in their entirety and without change, to customers and end users of the products.

1. **Limited Warranty:** Subject to the Limitation of Remedy and Liability below, Emerson Process Management Regulator Technologies, Inc. (“RTI”) warrants that the Goods manufactured by RTI will be free from defects in materials or workmanship under normal use and care until the expiration of the warranty period. Goods are warranted for five (5) years from the date of manufacture. Products purchased by RTI from a third party for resale to Distributor and/or its customers (each a “Buyer”) (“Resale Products”) shall carry only the warranty extended by the original manufacturer. Buyer agrees that RTI has no liability for Resale Products beyond making a reasonable commercial effort to arrange for procurement and shipping of the Resale Products. If Buyer discovers any warranty defects and notifies RTI thereof in writing during the applicable warranty period, RTI shall, at its option, repair or replace FOB point of manufacture that portion of the Goods found by RTI to be defective, or refund the purchase price of the defected portion of the Goods. Failure by Buyer to give such written notice within the applicable time period specified above shall be deemed an absolute and unconditional waiver of the Buyer’s claims for such defects. All replacements or repairs necessitated by inadequate maintenance, normal wear and usage, unsuitable power sources or environmental conditions, accident, misuse, improper installation, modification, repair, storage or handling, or any other cause not the fault of RTI are not covered by this limited warranty, and shall be at Buyer’s expense. RTI shall not be obligated to pay any costs or charges incurred by Buyer or any other party except as may be agreed upon in writing in advance by RTI. All costs of dismantling, reinstallation, and freight and the time and expenses of RTI’s personnel and representatives for site travel and diagnosis under this warranty clause shall be borne by Buyer unless accepted in writing by RTI. Goods repaired and parts replaced by RTI during the warranty period shall be in warranty for the remainder of the original warranty period or ninety (90) days, whichever is longer. This limited warranty is the only warranty made by RTI and can be amended only in writing signed by RTI. THE WARRANTIES AND REMEDIES SET FORTH ABOVE ARE EXCLUSIVE. THERE ARE NO REPRESENTATIONS OR WARRANTIES OF ANY KIND, EXPRESS OR IMPLIED, AS TO MERCHANTABILITY, FITNESS FOR PARTICULAR PURPOSE OR ANY OTHER MATTER WITH RESPECT TO ANY OF THE GOODS OR SERVICES

2. **LIMITATION OF REMEDY AND LIABILITY:** RTI SHALL NOT BE LIABLE FOR DAMAGES CAUSED BY DELAY IN PERFORMANCE. THE REMEDIES OF BUYER SET FORTH ABOVE ARE EXCLUSIVE. IN NO EVENT, REGARDLESS OF THE FORM OF THE CLAIM OR CAUSE OF ACTION (WHETHER BASED IN CONTRACT, INFRINGEMENT, NEGLIGENCE, STRICT LIABILITY, OTHER TORT OR OTHERWISE), SHALL RTI’S LIABILITY TO BUYER AND/OR ITS CUSTOMERS EXCEED THE PRICE TO BUYER OF THE SPECIFIC GOODS MANUFACTURED BY RTI GIVING RISE TO THE CLAIM OR CAUSE OF ACTION. BUYER AGREES THAT IN NO EVENT SHALL RTI’S LIABILITY TO BUYER AND/OR ITS CUSTOMERS EXTEND TO INCLUDE INCIDENTAL, CONSEQUENTIAL OR PUNITIVE DAMAGES. THE TERM “CONSEQUENTIAL DAMAGES” SHALL INCLUDE, BUT NOT BE LIMITED TO, LOSS OF ANTICIPATED PROFITS, REVENUE OR USE AND COSTS INCURRED INCLUDING WITHOUT LIMITATION CAPITAL, FUEL AND POWER, AND CLAIMS OF BUYER’S CUSTOMERS. RTI shall not be liable for and Buyer assumes all liability for, all personal injury (including without limitation death) and property damage in connection with or arising from the handling, transportation, possession, processing, further manufacture, other use or resale of the Goods, whether the Goods are used alone or in combination with any other material. Neither transportation charges for the return of the Goods nor any other costs, charges or expenses incurred by Buyer will be paid by RTI unless authorized in advance and in writing by RTI. All Goods returned for repair are to be shipped prepaid for the account of the Buyer by a mode of transportation approved by RTI. If RTI furnishes technical or other advice to Buyer, whether or not at Buyer’s request, with respect to processing, further manufacture, or other use or resale of the Goods, RTI shall not be liable for, and Buyer assumes all risk of, such advice and the results thereof.

3. Emerson Process Management Regulator Technologies, Inc. and their affiliated entities assume no responsibility for the selection, use or maintenance of any product. Responsibility for proper selection, use and maintenance of any product remains solely with the purchaser and end user.

4. The pricing information contained herein is “Confidential” and shall not be disclosed to third parties. While every attempt has been made to assure the accuracy and completeness of the information contained herein, RTI offers no warranty or guarantee, express or implied, regarding the information. All sales are governed by RTI’s terms and conditions of sale, which are available upon request. RTI reserves the right to (i) modify and/or improve its designs or specifications of its products; (ii) discontinue its products; and/or (iii) modify its pricing, without notice, at any time.

The Emerson logo is a trademark and service mark of Emerson Electric Co. All other marks are the property of their prospective owners. Fisher™ is a mark owned by Fisher Controls International LLC, a business of Emerson Automation Solutions.

## INDEX

Series / Type No.	Page No.	Series / Type No.	Page No.
50	45	H5118	67
64	31	HSRL	26
64SR	31	J	76
67C	30	M	77
99	34/40	MR98H	43
133	40	N100	74
289H	43	N110	75
299H	40	N120	75
627	32	N201	81
630	32	N301	71
63EGLP	69	N310	71
749B-21	41	N310F-24	71
803	41	N350	71
912	44	N401	71
1098	35	N410	71
1301F	32	N410F-24	71
1805	43	N450	71
C404-32	55	N480	73
C407-10	47	N551	62
C471	47	N562	64
C477	47	N563	64
C483	53	P	60
C484	53	P120B	81
C486	47	P600	47
C800	48/56	P700	47
CS200	36	R122H	25
CS400	36	R130	41
CS403	38	R222	25
CS404	38	R222H	25
CS404	38	R232A	28
CS800	36	R232E	29
CS803	38	R622	26
D	73	R622E	27
F100	66	R622H	25
G	72	R632A	28
H100	70	R632E	29
H284	68	R642	26
H722	67	R652	26
H733	67	R652E	27
H5114	68	Y602	44

### WARNING

The contents of this publication are presented for informational purposes only, and while every effort has been made to ensure their accuracy, they are not to be construed as warranties or guarantees, express or implied, regarding the products or services described herein or their use or applicability. We reserve the right to modify or improve the designs or specifications of such products at any time without notice.

NOTICE: See individual product instruction manuals supplied with the product for more detailed information. Contact Emerson or your local LPG Regulators and Equipment Distributor if you have additional product questions.

**WARNING:** Fisher™ equipment must be installed, operated and maintained in accordance with federal, state and local codes, and Fisher instructions. The installation in most states must also comply with National Fire Protection Association 54 and 58 standards.

Only personnel trained in the proper procedures, codes, standards, and regulations of the LPG or Anhydrous Ammonia (NH<sub>3</sub>) industries should install and service this equipment.

Due to normal wear or damage that may occur from external sources, Fisher equipment must be inspected and maintained periodically. The frequency of inspection and replacement of equipment depends upon the severity of the service conditions or age requirements of local, state, federal regulations and Fisher instructions.

Do not use any Fisher equipment that leaks, fails to work properly or that has damaged or missing parts. Equipment repair or replacement should be made promptly in order to prevent accidents.

Failure to follow these instructions or to properly install and maintain this equipment could result in an explosion and/or fire causing property damage, personal injury or death.

# LP-Gas Technologies

Regulators and Equipment, LPG/NH<sub>3</sub>  
LP-31 Buyer's Guide (2017-2018)

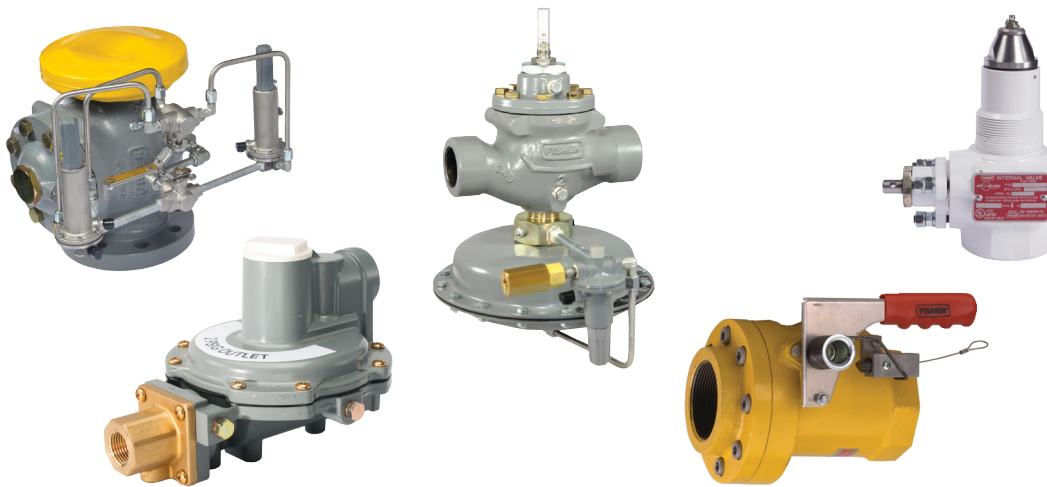

**FISHER™**

Our distribution network offers a full complement of sales and support staff, and more than 2000 technical experts strategically located across nearly 200 locations.

#### Emerson Automation Solutions

##### Americas

T +1 800 558 5853  
T +1 972 548 3574

 [webadmin.regulators@emerson.com](mailto:webadmin.regulators@emerson.com)

 [Fisher.com](http://Fisher.com)

##### Europe

T +39 051 419 0611

 [Facebook.com/EmersonAutomationSolutions](https://www.facebook.com/EmersonAutomationSolutions)

 [LinkedIn.com/company/emerson-automation-solutions](https://www.linkedin.com/company/emerson-automation-solutions)

##### Asia Pacific

T +65 6770 8337

 [Twitter.com/emr\\_automation](https://twitter.com/emr_automation)

##### Middle East / Africa

T +971 4811 8100

D450104T012 © 2009, 2017 Emerson Process Management Regulator Technologies, Inc. All rights reserved. 10/17.  
The Emerson logo is a trademark and service mark of Emerson Electric Co. All other marks are the property of their prospective owners.  
Fisher™ is a mark owned by Fisher Controls International LLC, a business of Emerson Automation Solutions.



**EMERSON. CONSIDER IT SOLVED.™**