

# Diaphragm Valve, Metal

## Construction

The GEMÜ 605 pneumatically operated 2/2-way diaphragm valve has a low maintenance piston actuator which can be controlled by inert gases. The valve has an integrated optical position indicator. Normally Closed, Normally Open and Double Acting control functions are available.

## Features

- Suitable for inert and corrosive\* liquid and gaseous media
- Insensitive to particulate media
- Valve body and diaphragm available in various materials and designs
- Compact design (ideal when space is at a premium)
- CIP/SIP cleaning and sterilizing capabilities
- Versions according to ATEX on request

## Advantages

- Hermetic separation between medium and actuator
- For sterile applications
- Optional flow direction
- Installation for an optimized draining is possible
- Optional accessories
  - Stroke limiter
  - Electrical position indicators with microswitches or proximity switches

\*see information on working medium on page 2



Sectional drawing

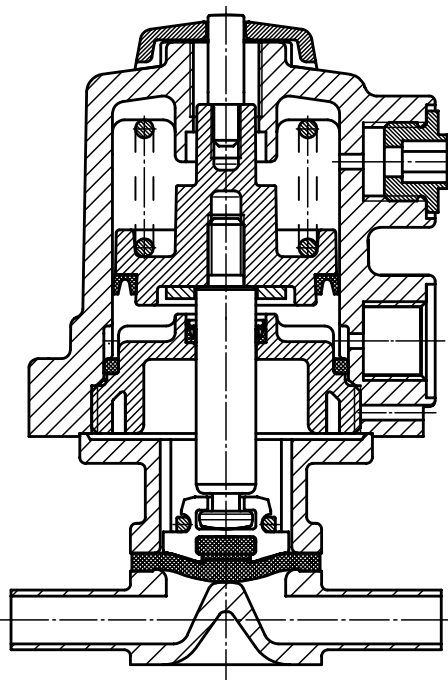

## Technical data

### Working medium

Corrosive, inert, gaseous and liquid media which have no negative impact on the physical and chemical properties of the body and diaphragm material.

### Temperatures

#### Media temperature

FKM (Code 4A)	14 ... 194 °F
EPDM (Code 3A)	14 ... 212 °F
EPDM (Code 17)	14 ... 212 °F
PTFE/EPDM (Code 54)	14 ... 212 °F

#### Sterilisation temperature <sup>(1)</sup>

FKM (Code 4A)	not applicable
EPDM (Code 3A)	max. 302 °F <sup>(2)</sup> , max. 60 min per cycle
EPDM (Code 17)	max. 302 °F <sup>(2)</sup> , max. 180 min per cycle
PTFE/EPDM (Code 54)	max. 302 °F <sup>(2)</sup> , no time limit per cycle

<sup>1</sup> The sterilisation temperature is valid for steam (saturated steam) or superheated water.

<sup>2</sup> If the sterilisation temperatures listed above are applied to the EPDM diaphragms for longer periods of time, the service life of the diaphragms will be reduced. In these cases, maintenance cycles must be adapted accordingly. This also applies to PTFE diaphragms exposed to high temperature fluctuations.

PTFE diaphragms can also be used as moisture barriers; however, this will reduce their service life.

The maintenance cycles must be adapted accordingly.

GEMÜ 555 and 505 globe valves are particularly suitable for use in the area of steam generation and distribution.

The following valve arrangement for interfaces between steam pipes and process pipes has proven itself over time:

A globe valve for shutting off steam pipes and a diaphragm valve as an interface to the process pipes.

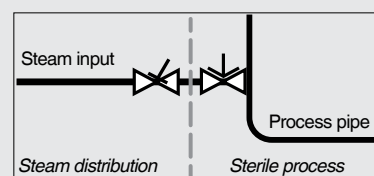

#### Ambient temperature

32 ... 140 °F

### Control medium

#### Inert gases

#### Max. perm. temperature of control medium

104 °F

#### Filling volume

1.22 cinch

Diaphragm size	Operating pressure [psi]		Control pressure [psi]	
	EPDM / FKM	PTFE	C.f. 1	C.f. 2 + 3
8	0 - 120	0 - 90	58 - 102	max. 58 psi (see diagram)

All pressures are gauge pressures. Operating pressure values were determined with static operating pressure applied on one side of a closed valve. Sealing at the valve seat and atmospheric sealing is ensured for the given values. Information on operating pressures applied on both sides and for high purity media on request.

## Technical data

Cv values [gpm]								
Pipe standard	DIN	EN 10357 series B (formerly DIN 11850 series 1)	EN 10357 series A (formerly DIN 11850 series 2) / DIN 11866 series A	DIN 11850 Series 3	SMS 3008	ASME BPE / DIN 11866 series C	ISO 1127 / EN 10357 series C / DIN 11866 series B	
Connection code	0	16	17	18	37	59	60	
MG	DN							
8	4	0.6	-	-	-	-	-	-
	6	-	-	1.3	-	-	-	1.4
	8	-	-	1.5	-	-	0.7	2.6
	10	-	2.5	2.5	2.5	-	1.5	-
	15	-	-	-	-	-	2.3	-

MG = diaphragm size

Cv values determined acc. to inlet pressure 75 psi,  $\Delta p$  1 psi, stainless steel valve body (forged body) and soft elastomer diaphragm.

The Cv values for other product configurations (e.g. other diaphragm or body materials) may differ. In general, all diaphragms are subject to the influences of pressure, temperature, the process and their tightening torques. Therefore the Cv values may exceed the tolerance limits of the standard.

The Cv value curve (Cv value dependent on valve stroke) can vary depending on the diaphragm material and duration of use.

## Control pressure / operating pressure diagram

Diaphragm material PTFE

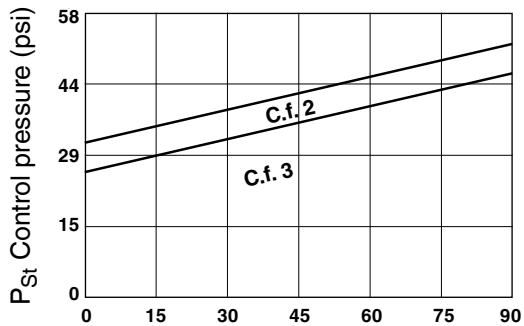

$P_B$  Operating pressure (psi)

Diaphragm material EPDM /FKM

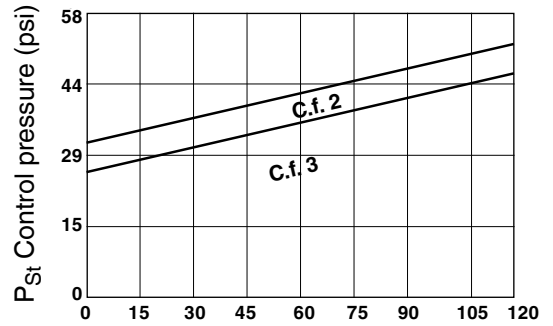

$P_B$  Operating pressure (psi)

The control pressure depending on the prevailing operating pressure, as shown in the diagram, is intended as a guide for operating the system with low wear on the diaphragm.

## Order data

Body configuration	Code
Tank valve body	B**
2/2-way body	D
T body	T*
* For dimensions see T Valves brochure	
** Dimensions and versions on request	

Nominal size	Code
DN 4	4
DN 6      NPS 1/8"	6
DN 8      NPS 1/4"	8
DN 10     NPS 3/8"	10
DN 15     NPS 1/2"	15

Valve body material	Code
1.4435, investment casting	C3
1.4408, investment casting	37
1.4435 (316 L), forged body	40
1.4435 (BN2), forged body $\Delta$ Fe<0,5%	42
1.4539, forged body	F4

Diaphragm material	Code
FKM	4A
EPDM	3A
EPDM	17
EPDM	19
EPDM	36
PTFE/EPDM, one-piece	54
Material complies with FDA requirements, except codes 4A	

Connection	Code
<b>Butt weld spigots</b>	
Spigots DIN	0
Spigots EN 10357 series B (formerly DIN 11850 series 1)	16
Spigot EN 10357 series A (formerly DIN 11850 series 2) / DIN 11866 series A	17
Spigots DIN 11850 series 3	18
Spigots JIS-G 3459	36
Spigots BS 4825 Part 1	55
Spigot ASME BPE / DIN 11866 series C	59
Spigot ISO 1127 / EN 10357 series C / DIN 11866 series B	60
Spigots ANSI/ASME B36.19M Schedule 10s	63
Spigots ANSI/ASME B36.19M Schedule 40s	65
<b>Threaded connections</b>	
Threaded sockets DIN ISO 228	1
Threaded spigots DIN 11851	6
Cone spigot and union nut DIN 11851	6K
Aseptic unions on request	
<b>Clamp connections</b>	
Clamps ASME BPE for pipe ASME BPE, length ASME BPE	80
Clamp DIN 32676 series B for pipe EN ISO 1127, length EN 558, series 7	82
Clamps ASME BPE for pipe ASME BPE, length EN 558, series 7	88
Clamps DIN 32676 series A for pipe DIN 11850, length EN 558, series 7	8A
Clamps DIN 32676 series C, length FTF ASME BPE	8P
Clamps DIN 32676 series C, length FTF EN 558 series 7	8T

Control function	Code
Normally closed      (NC)	1
Normally open        (NO)	2
Double acting        (DA)	3

Actuator size	Code
Diaphragm size 8	0/N

Surface finish	Code
See top of page 5	

## Order data

Special function	Code
3-A compliant design	M

Order example	605	8	D	60	C3	54	1	0/N	1500	M
Type	605									
Nominal size		8								
Body configuration (code)			D							
Connection (code)				60						
Valve body material (code)					C3					
Diaphragm material (code)						54				
Control function (code)							1			
Actuator size (code)								0/N		
Surface finish (code)									1500	
Special function (code)										M

### Internal surface finishes for forged and block material bodies <sup>1</sup>

Readings for Process Contact Surfaces	Mechanically polished <sup>2</sup>		Electropolished	
	Hygienic class DIN 11866	Code	Hygienic class DIN 11866	Code
Ra ≤ 0,80 µm	H3	1502	HE3	1503
Ra ≤ 0,60 µm	-	1507	-	1508
Ra ≤ 0,40 µm	H4	1536	HE4	1537
Ra ≤ 0,25 µm <sup>3</sup>	H5	1527	HE5	1516

Readings for Process Contact Surfaces acc. to ASME BPE 2016 <sup>4</sup>	Mechanically polished <sup>2</sup>		Electropolished	
	ASME BPE Surface Designation	Code	ASME BPE Surface Designation	Code
Ra Max. = 0,76 µm (30 µinch)	SF3	SF3	-	-
Ra Max. = 0,64 µm (25 µinch)	SF2	SF2	SF6	SF6
Ra Max. = 0,51 µm (20 µinch)	SF1	SF1	SF5	SF5
Ra Max. = 0,38 µm (15 µinch)	-	-	SF4	SF4

### Internal surface finishes for investment cast bodies

Readings for Process Contact Surfaces	Mechanically polished <sup>2</sup>	
	Hygienic class DIN 11866	Code
Ra ≤ 6,30 µm	-	1500
Ra ≤ 0,80 µm	H3	1502
Ra ≤ 0,60 µm <sup>5</sup>	-	1507

<sup>1</sup> Surface finishes of customized valve bodies may be limited in special cases.

<sup>2</sup> Or any other finishing method that meets the Ra value (acc. to ASME BPE).

<sup>3</sup> The smallest possible Ra finish for 1/4" (DN 8) BS 4825 Part 1 and ASME BPE is 15 µinch.

<sup>4</sup> When using these surfaces, the bodies are marked according to the specifications of ASME BPE.

The surfaces are only available for valve bodies which are made of materials (e.g. GEMÜ material codes 40, 41, F4, 44) and use connections (e.g. GEMÜ connection codes 59, 80, 88) according to ASME BPE.

<sup>5</sup> Not possible for GEMÜ connection code 59, DN 8 and GEMÜ connection code 0, DN 4.

Ra acc. to DIN EN ISO 4288 and ASME B46.1

## Dimensions [inch]

### Actuator dimensions

MG	A	A1	A2	B	B1	B2	A4	G	M	Weight [lbs]
8	3.94	1.54	1.18	2.24	1.38	2.68	0.16	G 1/4	M12x1	0.7

MG = diaphragm size

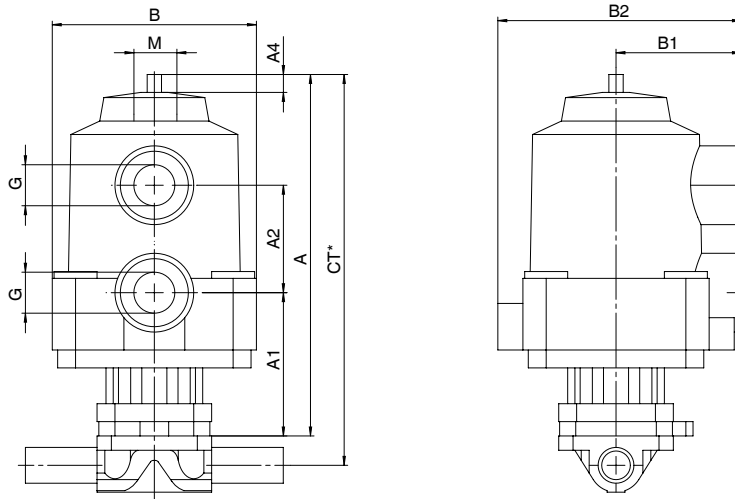

\* CT = A + H1 (see body dimensions)

## Body dimensions

### Threaded sockets, connection code 1 Valve body material: investment casting (code 37)

MG	DN	R	H [in]	H1 [in]	t [in]	L [in]	SW2 [mm]	Number of flats	Weight [lbs]
8	8	G1/4	0.75	0.35	0.43	2.83	18	6	0.2

MG = diaphragm size

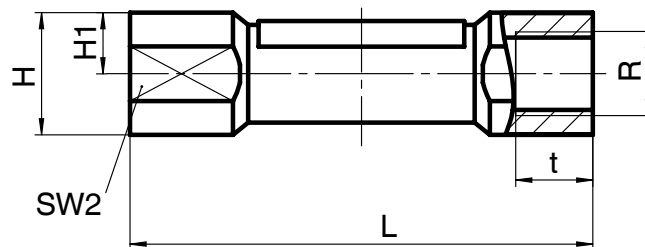

## Body dimensions [inch]

### Butt weld spigots, connection code 0, 16, 17, 18, 60 Valve body material: Investment casting (code C3), forged body (code 40, F4)

Pipe standard						DIN		EN 10357 series B (formerly DIN 11850 series 1)		EN 10357 series A (formerly DIN 11850 series 2) / DIN 11866 series A		DIN 11850 Series 3		ISO 1127 / EN 10357 series C / DIN 11866 series B		Weight [lbs]
Connection code						0		16		17		18		60		
MG	DN	NPS	L	c	H1	ød	s	ød	s	ød	s	ød	s	ød	s	
8	4	-	2.83	0.79	0.33	0.236	0.039	-	-	-	-	-	-	-	-	0.2
	6	-	2.83	0.79	0.33	-	-	-	-	0.315	0.039	-	-	0.402	0.063	0.2
	8	1/4"	2.83	0.79	0.33	-	-	-	-	0.394	0.039	-	-	0.531	0.063	0.2
	10	3/8"	2.83	0.79	0.33	-	-	0.472	0.039	0.512	0.059	0.551	0.079	-	-	0.2

MG = diaphragm size      For materials see overview on page 10

### Butt weld spigots, connection code 36, 55, 59, 63, 65 Valve body material: Investment casting (code C3), forged body (code 40, F4)

Pipe standard								JIS-G 3459		BS 4825 Part 1		ASME BPE/ DIN 11866 series C		ANSI/ASME B36.19M Schedule 10s		ANSI/ASME B36.19M Schedule 40s		Weight [lbs]
Connection code								36		55		59		63		65		
MG	DN	NPS	L	c	H1*	H1**	ød	s	ød	s	ød	s	ød	s	ød	s		
8	6	-	2.83	0.79	-	0.33	0.413	0.047	-	-	-	-	0.406	0.049	0.406	0.068	0.2	
	8	1/4"	2.83	0.79	0.33	0.33	0.543	0.065	0.250	0.047	0.250	0.035	0.539	0.065	0.539	0.088	0.2	
	10	3/8"	2.83	0.79	0.33	0.33	-	-	0.375	0.047	0.375	0.035	-	-	-	-	0.2	
	15	1/2"	2.83	0.79	0.33	0.33	-	-	0.500	0.047	0.500	0.065	-	-	-	-	0.2	

\* only for investment cast design      \*\* only for forged design      MG = diaphragm size  
For materials see overview on page 10

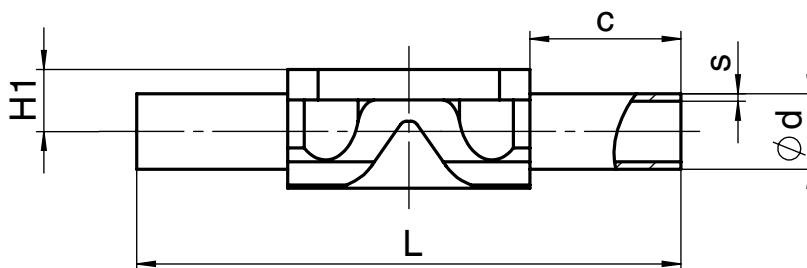

## Body dimensions [inch]

### Threaded connections, connection code 6 Valve body material: Forged body (code 40)

MG	DN	H1	ød1	Thread to DIN 405 R	L	Weight [kg]
8	10	0.33	0.394	RD 28 x 1/8	3.62	0.5

MG = diaphragm size

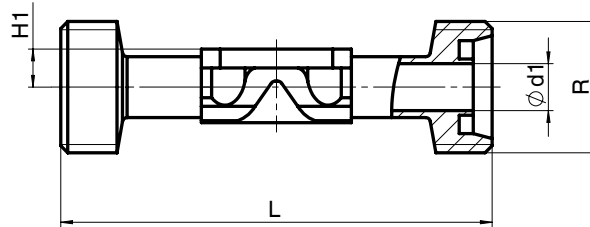

### Cone spigot, connection code 6K Valve body material: Forged body (code 40)

MG	DN	H1	ød1	Thread to DIN 405 R	L	Weight [kg]
8	10	0.33	0.394	RD 28 x 1/8	3.54	0.5

MG = diaphragm size

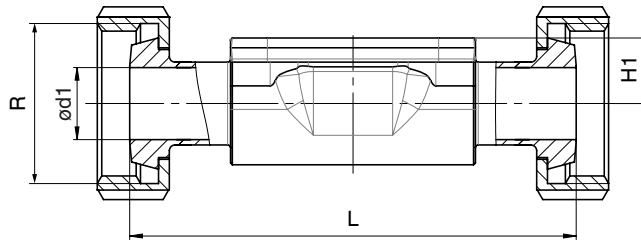

### Clamp connections, connection code 80, 82, 88, 8A, 8P, 8T Valve body material: Forged body (code 40, F4)

Pipe connection for clamp				ASME BPE						ISO 1127 / EN 10357 series C / DIN 11866 series B			EN 10357 series A (formerly DIN 11850 series 2) / DIN 11866 series A			Weight [lbs]
Clamp connection				Code 80, 88 - ASME BPE Code 8P, 8T - DIN 32676 series C						DIN 32676 series B			DIN 32676 series A			
Clamp connection code				80, 8P			88, 8T			82			8A			
MG	DN	NPS	H1	ød1	ød3	L	ød1	ød3	L	ød1	ød3	L	ød1	ød3	L	
8	6	1/8"	0.33	-	-	-	-	-	-	0.276	0.984	2.5	0.236	0.984	2.5	-
	8	1/4"	0.33	0.180	0.984	2.5	-	-	-	0.406	0.984	2.5	0.315	0.984	2.5	0.3
	10	3/8"	0.33	0.305	0.984	2.5	-	-	-	-	-	-	0.394	1.339	3.5	0.4
	15	1/2"	0.33	0.370	0.984	2.5	0.370	0.984	4.25	-	-	-	-	-	-	0.4

MG = diaphragm size

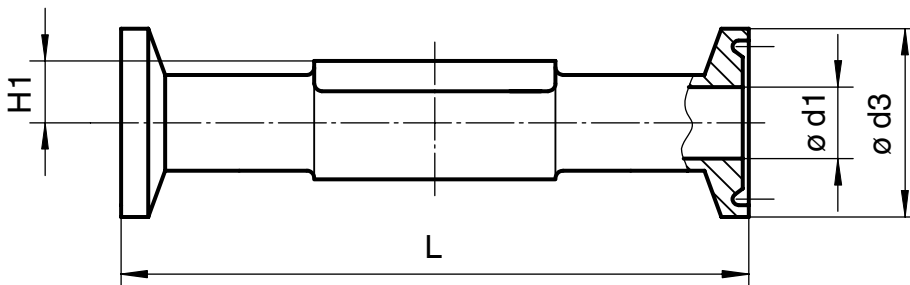



Overview of valve bodies for GEMÜ 605															
		Spigots													
Connection code		0		16	17		18	36	55	59		60		63	65
Material code		C3	40	40	C3	40	40	40	40	C3	40	C3	40	40	40
MG	DN														
8	4	X	X	-	-	-	-	-	-	-	-	-	-	-	-
	6	-	-	-	X	X	-	X	-	-	-	-	X	X	X
	8	-	-	-	X	X	-	X	X	X	X	X	X	X	X
	10	-	-	X	X	X	X	-	X	X	X	-	-	-	-
	15	-	-	-	-	-	-	-	X	X	X	-	-	-	-

Availability of material code 42, F4: same as code 40  
MG = diaphragm size

All rights including copyright and industrial property rights are expressly reserved.

Overview of valve bodies for GEMÜ 605								
		Threaded connections				Clamps		
Connection code		1	6	6K	80, 8P	82	88, 8T	8A
Material code		37	40	40	40	40	40	40
MG	DN							
8	6	-	-	-	-	K	-	K
	8	X	-	-	K	K	-	K
	10	-	W	W	K	-	-	W
	15	-	-	-	K	-	W	-

X = Standard  
K = Connections completely machined (not welded)  
W = Welded construction  
Availability of material code 42, F4: same as code 40  
MG = diaphragm size

Should there be any doubts or misunderstandings, the German version of this data sheet is the authoritative document!

For further metal diaphragm valves, accessories and other products, please see our Product Range catalogue and Price List.  
Contact GEMÜ.

Subject to alteration · 11/2021 · 88723625