

Pressure Reducing Valve

1

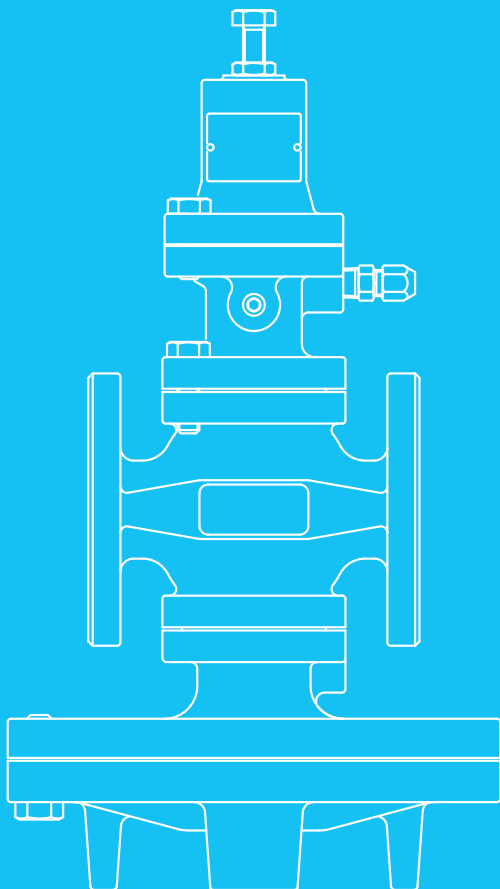

Step 0 Type/Structure/Features

Please refer to this for structure and features of Pressure Reducing Valve.

Step 1 Selection

Please look at the ID chart to select the right products depending on the intended uses.
Details are on the product page.

Step 2 Sizing

Please check the required Cv value from size selection data on P.1-14, or size selection chart on the product page of each products.

Step 3 Attentions for usage

Please check some guidelines for optimal usage of the products such as installation.

Selection of Pressure Reducing Valve

What is PRV?

It is a regulating valve which keeps outlet pressure of fluid at a certain and lower level than inlet pressure.

Direct acting type ■-7

Has sensing element for reduced pressure which directly actuates the valve. It is compact and light weight, and ideal for controlling small flow rate.

Main application

- Food/Laundry equipment,
 - Equipment using air of low pressure,
 - Steam sterilization system, etc.
- Simple structure and ideal for small flow rate

Pilot-operated type

Has pilot which senses reduced pressure and directly actuates. The main valve is controlled and actuated by the pressure applied from the pilot. It offers high flow rate and stable control.

Diaphragm type ■-5

Has large diaphragm which operates main valve. It has large Cv value, with minimum fluctuation in reduced pressure even while controlling min. controllable flow rate or rated flow. It shows similar performance as control valve.

Main application

- Building/Air-conditioning facilities,
 - Plant facilities, etc.
- Outstanding controllability and large flow rate, due to main valve controlled by large main diaphragms having large pressure receiving surface.

Piston type ■-6

Has a piston adopted at the operating part of main valve. It is mainly used in steam line, and has excellent controllability for reduced pressure with fluctuation of 0.05 MPa or less (*).

Main application

- Building/Air-conditioning facilities,
 - Plant facilities, etc.
- Excellent durability and wide range of application from small to large flow rates, due to main valve controlled by piston.

* For GP-1000 series

Reduced Pressure Sensing Method and Controllability

External sensing

GP-2000 series operate stably even in the application of violent flow rate fluctuation, with the external sensing method adopted as standard specification. This method enhances stability of the steam pressure inside the equipment because the reduced pressure can be detected directly from the sensing point.

Precaution for outlet pipe sizing

Steam is a compressible fluid and its volume per unit mass become larger as its pressure decreases. This characteristics causes unexpected pressure drop in steam pressure due to pipe resistance which results from over flow rate of steam. The over flow rate can be caused by lowering steam pressure to a certain level by a pressure reducing valve. In this case, please use the larger outlet pipe selected according to the steam volume at lower pressure, then the unexpected trouble disappears.

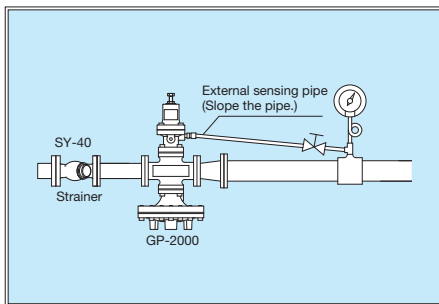

Performance - Flow Characteristics

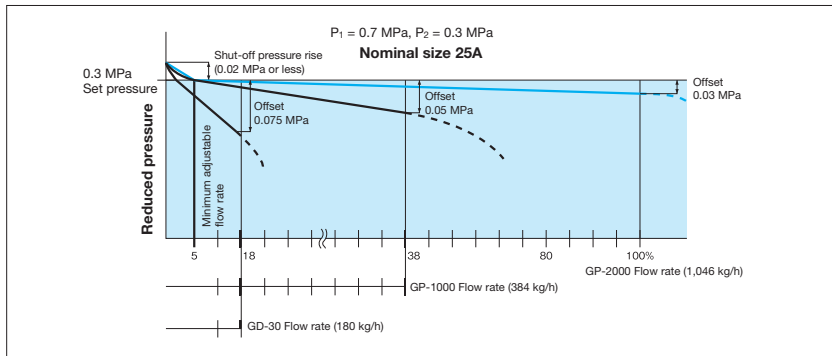
 Step
0

Flow characteristics

“Pressure stability” can be achieved by minimizing offset that varies with steam consumption. Thus, the performance of a pressure reducing valve can be determined not only by how large capacity but also by how small offset it shows.

Definitions

Yoshitake defines **Set pressure** as the pressure at which the fluid flows slightly, not as the pressure at which the valve is actually operating at site. This is because it is hard to know at which percentage of its capacity the valve is actually working. Yoshitake also defines: **Shut-off pressure rise** as the increase in pressure while the valve is completely closed; and **Offset** as the fluctuation in the reduced pressure while the flow rate varies.

Utilization - Save Energy

Pressure control in main steam line

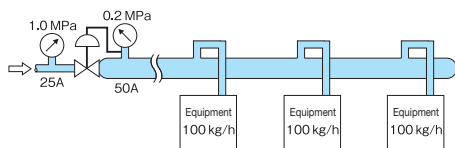

Pressure control in branch

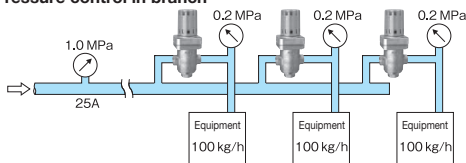

Control in branch can:

- Reduce heat discharge and initial cost by decreasing steam pipe size.
- Enhance steam quality by reducing pressure just before the equipment
- Lessen effects on operation due to trouble with the pressure reducing valve

* Please refer to “Proper piping diameter” on P.1-16.

Pilot-operated Diaphragm Type for Steam Application- GP-2000 series

GP-2000 is suitable for:

- Building facilities;
- Plant facilities;
- Steam main;
- Equipment requiring large flow rate/high accuracy/high pressure reduction ratio/low-pressure control

GP-2000 has large main diaphragm that accurately responds to even small fluctuation in the reduced pressure. It also can be used in low-pressure lines presenting high capacity and stable control.

STRAINER

Built-in strainer of 200 mesh

Free of scale troubles at pilot valve.

DIAPHRAGM

Patented ACDC (Anti-crack diaphragm case)

Highly durable because of ACDC that makes the pressure equally transmitted onto the bottom side of the main diaphragm (10 times more durable than equivalent products of other manufacturers.)

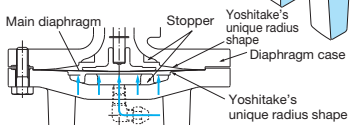

NEW PILOT VALVE

PPV: Pull-up pilot valve

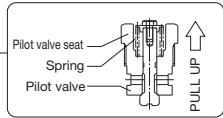

PPV ensures tight sealing even during long-time service.

MAIN VALVE

Hemispherical main valve ensures tight shut-off, meeting ANSI Class IV.

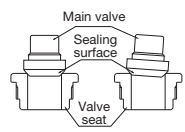

* Hemispherical sealing surface ensures tightness even if the valve closes at an angle.

FCD PARTS

Parts subject to pressure including body, diaphragm case are made of FCD of high strength.

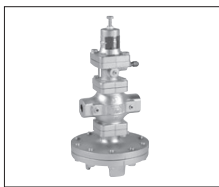
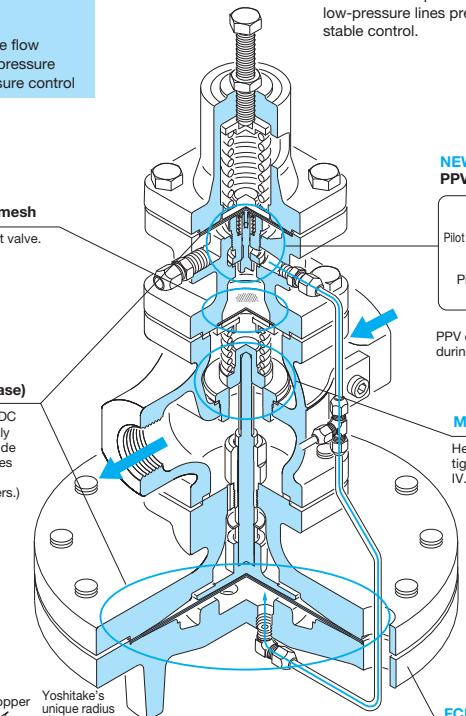

Screwed type

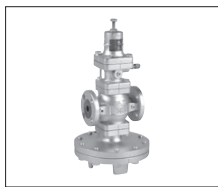

Flanged type

Pilot-operated Piston Type for Steam Application – GP-1000 series

Step
0

GP-1000 is suitable for :

- Building facilities;
- Air-conditioning facilities;
- Plant facilities;
- Frequently working application;
- Versatile application
- Compact and lightweight

GP-1000 is the crystallization of the Yoshitake's technology for piston-type in performance, quality and durability.

STRAINER

Built-in strainer of 200 mesh

Free of scale troubles at pilot valve.

FCD BODY

FCD Body of higher strength ensures improved safety.

NEW PILOT VALVE

PPV: Pull-up pilot valve

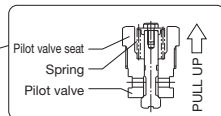

PPV ensures tight sealing even during long-time service.

INTERNAL SENSING

Easy installation due to reduced pressure sensing port inside the body.

PISTON and CYLINDER

Stable operation due to TGD (Twin Guide Design) during long-time service.

MAIN VALVE

Hemispherical main valve ensures tight shut-off, meeting ANSI Class IV.

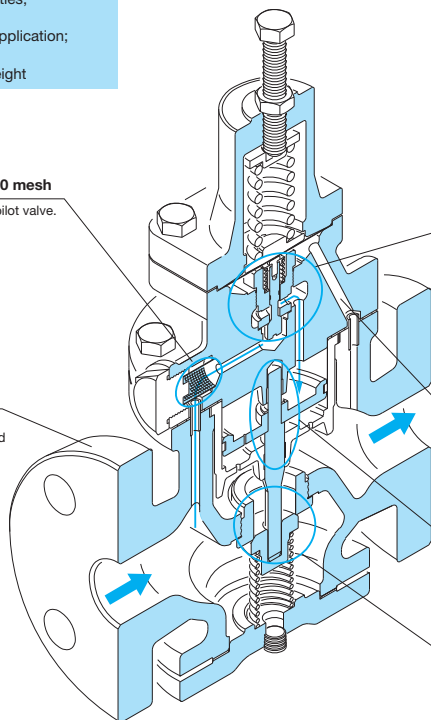

Variations



GP-1010 screwed type



GP-1200 air loading type



GP-1000SS, AS stainless-steel made

Direct-acting Type for Steam Application – GD-30 series

GD-30 is suitable for:

- Food machinery;
- Laundry equipment;
- Medical equipment;
- Air-conditioning equipment;
- Best choice for steam line of small flow rate.

GD-30 is a direct-acting type of compact and lightweight. It is highly durable with valve and valve seat made of stainless steel, and with external pressure type bellows. GD-30S is optimal for food and medical equipment with stainless steel wetted parts.



NO NEED OF TOOL

Reduced pressure can be easily adjusted by handle.

ANTI SCALE

Free of scale trouble at valve and valve seat with strainer of 60 mesh.

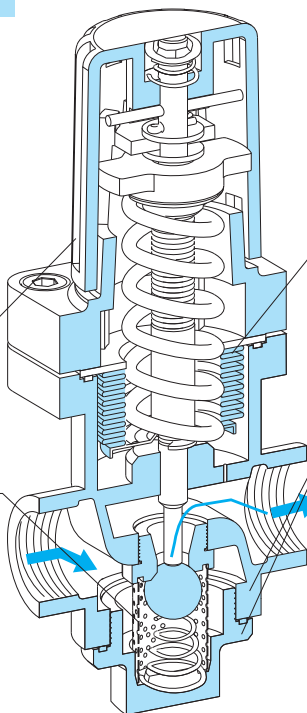

HIGH-PERFORMANCE BELLOWS

High performance and durability during long-time service with external pressure type bellows made of SUS316L (GD-30S).

HIGH CORROSION RESISTANCE

Body and cap made of SCS14A for high corrosion resistance. (GD-30S)

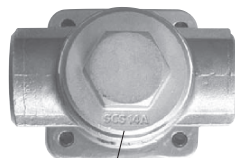

Material is shown on back surface of the cap for easy recycling.



GD-30 with CAC406 body



GD-30S with stainless-steel wetted parts







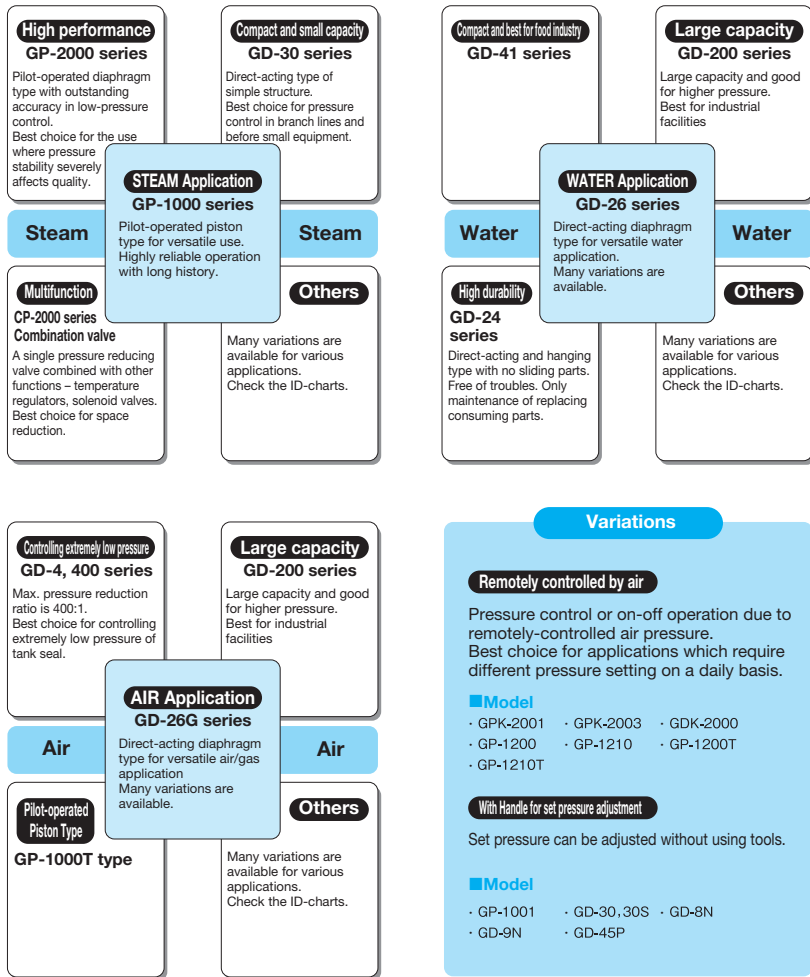

Pressure Reducing Valve Selection Chart

Step
0

You can select the optimal valve from various series and variations.
 Please check this chart first, and then proceed to ID-charts to find each product page.











Pressure Reducing Valve (for Steam) ID-Charts

	Model	Type	Fluid	Body material	Inlet press. (MPa)	Reduced press. (MPa)	Max. temp. (°C)	Piping		Connection	Nominal size	Features	Page	
								Vertical	Horizontal					
	GP-2000	Pilot-operated Diaphragm	Steam	FCD450	0.1-2.0	0.02-1.4	220°C			O	JIS Rc	15-50A	High accuracy Best for severe control of lower pressure	I-23
	GP-2000EN										JIS 10KFF JIS 20KRF EN PN25			
	GPK-2001	Pilot-operated Diaphragm	Steam	FCD450	0.1-2.0 (JIS 10K) (0.1-1.0)	0.05-0.9 (JIS 10K) (0.05-0.85)	220°C			O	JIS Rc	15-50A	Remote control by air pressure High accuracy equivalent to GP-2000	I-27
	GPK-2003				JIS 10KFF JIS 20KRF	15-100A								
					JIS Rc	15-50A								
	GDK-2000	Direct-acting Diaphragm	Steam	FCD450	0.1-2.0	0.05-1.4	220°C			O	JIS Rc	15-50A	Remote control by air pressure Large flow rate equivalent to GP-2000	I-29
											JIS 10KFF JIS 20KRF	15-100A		
	CP-2000 series combination valve	Pilot-operated Diaphragm	Steam	FCD450	Refer to P. I-33 to 36.					O	JIS Rc	15-50A	Multifunction Combination of PRV, solenoid valve, and temp. regulator.	I-33
											JIS 10KFF JIS 20KRF	15-100A		
	GP-2000CS	Pilot-operated Diaphragm	Steam	WCB	0.1-3.0	0.02-2.0 (JIS 10K) (0.02-0.85)	260°C			O	JIS Rc	15-50A	For higher pressure Cast steel-made GP-2000	I-37
											JIS 10KFF JIS 20KRF JIS 30KRF	15-100A		
	GP-1000	Pilot-operated Diaphragm	Steam	FCD450	0.1-1.0	0.05-0.9	220°C			O	JIS 10KFF	15-100A	For versatile steam application GP-1000 for controlling lower pressure	I-41
	GP-1000S										EN PN16			
	GP-1002										JIS 10KFF			
	GP-1001	Pilot-operated Piston	Steam	FCD450	0.1-1.0	0.05-0.9	220°C			O	JIS 10KFF	15-100A	With handle for set pressure adjustment Set pressure can be adjusted without using tools.	I-41
	GP-1010				0.1-1.0	0.05-0.9					JIS Rc	15-50A	Screwed type of GP-1000	I-41



















* Please contact us for fluid applications or connections other than above.



	Model	Type	Fluid	Body material	Inlet press. (MPa)	Reduced press. (MPa)	Max. temp. (°C)	Piping		Connection	Nominal size	Features	Page
								Vertical	Horizontal				
	GP-1000H	Pilot-operated Piston	Steam	FCD450	0.1-1.6	0.05-1.4	220°C	O		JIS 16KFF	15-100A	For higher pressure GP-1000 for controlling higher pressure	T-47
	GP-1000HN									EN PN25			
	GP-1000SS			SCS13	0.1-1.0	0.05-0.9				JIS 10KFF	15-100A	Anti-corrosion with stainless steel-made wetted parts	T-42
	GP-1000AS									Anti-corrosion with all stainless steel-made		T-42	
	GP-1200	Pilot-operated Piston	Steam	FCD450	0.1-1.0	0.05-0.9	220°C	O		JIS 10KFF	15-100A	Remote control by air pressure	T-41
	GP-1210									JIS Rc			15-50A
	GP-27	Pilot-operated Piston	Steam	FCD450	0.1-1.0	0.03-0.8	220°C	O		JIS 10KFF	125-200A	Large size for versatile use	T-50
	GD-30	Direct-acting Bellows	Steam	CAC406	1.7 or less	0.02-1.0	210°C	O		JIS Rc	15-25A 40A-50A	With handle for set pressure adjustment Compact and lightweight	T-52
	GD-30S			SCS14A	2.0 or less						220°C	15-25A	GD-30 with stainless steel-made wetted parts
	GD-45	Direct-acting Bellows	Steam	FCD450	2.0 or less	0.02-1.0	220°C	O		JIS Rc	15-25A		T-54
	GD-45P	Direct-acting Bellows	Steam	FCD450	2.0 or less	0.02-1.0	220°C	O		JIS Rc	15-25A	With handle for set pressure adjustment	T-54
	GD-6N	Direct-acting Diaphragm	Steam	FCD450	1.0 or less	0.02-0.4	220°C	O		JIS Rc	10-25A		T-56
				SCS13									
PRV Station	PRVS-1	-	Steam	STPG 370 (Piping)	1.0Mpa or less	0.05-0.9	220°C	O		JIS10KFF	15-100A	Outlet connection is 1 size up of inlet connection.	T-58
	PRVS-2											Outlet connection is 2 size up of inlet connection.	

* Please contact us for fluid applications or connections other than above.















Pressure Reducing Valve (for Air/ for Water) ID-Charts

	Model	Type	Fluid	Body material	Inlet press. (MPa)	Reduced press. (MPa)	Max. temp. (°C)	Piping Vertical Horizontal	Connection	Nominal size	Features	Page	
	GD-26-NE	Direct-acting Diaphragm	Cold and hot water	CAC406	1.0 or less	0.05-0.7	5-90°C	○	○	JIS Rc	15-50A	For versatile cold and hot water application 	11-60
	GD-26-NE				1.6 or less							For higher pressure 	11-60
	GD-26S			SCS13	1.0 or less	0.05-0.7	5-90°C	○	○	JIS Rc	20-50A	Stainless steel-made wetted parts	11-62
	GD-26S-NE				1.6 or less							Stainless steel-made wetted parts 	11-62
	GD-28S				1.6 or less							For higher pressure 	11-62
	GD-27-NE	Direct-acting Diaphragm	Cold and hot water	CAC406	1.0 or less	0.05-0.7 (0.05-0.5 for 125A and 150A of GD-27-N)	5-90°C (5-80°C for 125A and 150A of GD-27-N)	○	○	JIS 10KFF	25-150A	For versatile cold and hot water application 	11-60
	GD-29-NE				1.6 or less					JIS 16KFF	25-100A	For higher pressure 	11-60
	GD-27S			SCS13	1.0 or less	0.05-0.7 (0.05-0.5 for 125A and 150A of GD-27-N)	5-90°C (5-80°C for 125A and 150A of GD-27-N)	○	○	JIS 10KFF	20-100A	Stainless steel-made wetted parts	11-62
	GD-27S-NE				1.6 or less							Stainless steel-made wetted parts 	11-62
	GD-29S				1.6 or less							JIS 16KFF	For higher pressure 
	GD-27BP	Direct-acting Diaphragm	Cold and hot water	CAC406	1.0 or less	0.05-0.7	5-90°C	○ * Only up to 80A	○	JIS 10KFF	20-100A	With by-pass function 	11-66
	GD-26G	Direct-acting Diaphragm	Air	CAC406	1.0 or less	0.05-0.7	5-90°C	○	○	JIS Rc	15-50A	For versatile air application 	11-95
	GD-26GS			SCS13	1.0 or less	0.05-0.7	5-90°C	○	○	JIS Rc	20-50A	Stainless steel-made wetted parts	11-97
	GD-27S	Direct-acting Diaphragm	Air	CAC406	1.0 or less	0.05-0.7	5-90°C	○	○	JIS 10KFF	25-100A	For versatile air application 	11-95
	GD-27GS			SCS13	1.0 or less	0.05-0.7	5-90°C	○	○	JIS 10KFF	25-100A	Stainless steel-made wetted parts	11-97
	GD-24	Direct-acting Diaphragm	Cold and hot water	CAC406	0.2-1.6	0.05-0.55	5-80°C	○	○	JIS Rc	15-50A	Long service life 	11-70

* Please contact us for fluid applications or connections other than above.











Step 1

	Model	Type	Fluid	Body material	Inlet press. (MPa)	Reduced press. (MPa)	Max. temp. (°C)	Piping Vertical Horizontal	Connection	Nominal size	Features	Page	
	GD-200	Direct-acting Diaphragm	Cold and hot water, Oil, Air	FCD450	1.0 or less	0.05-0.7 (0.05-0.5 for 100A to 150A)	5-80°C	○ ○ Only up to 80A	JIS 10KFF	15-150A	Large capacity	I-72	
	GD-200H				2.0 or less	15-50A: 0.05-1.0 65-80A: 0.05-0.9 100-150A: 0.05-0.75	5-80°C				JIS 20KRF	15-150A	For higher pressure
	GD-200C	Direct-acting Diaphragm	Cold and hot water, Oil, Air	FCD450	1.0 or less	0.05-0.7 (0.05-0.5 for 100A to 150A)	5-60°C	○	JIS 10KFF	15-150A	Nylon-coated	I-72	
	GD-200C-N		Cold and hot water								Nylon-coated 		
	GD-20	Direct-acting Diaphragm	Cold and hot water, Oil, Air	SCS13	1.0 or less	0.05-0.7 (0.05-0.5 for 100A)	5-80°C	○ ○ Only up to 80A	○	JIS 10KFF	15-100A	Stainless-made model equivalent to GD-200	I-74
	GD-41	Direct-acting Diaphragm	Cold and hot water	SCS14A	2.0 or less	0.02-0.5	5-90°C	○	○	JIS Rc	15-25A	Stainless steel-made wetted parts 	I-78
	GD-41N				1.0 or less							Stainless steel-made wetted parts 	I-78
	GD-43-10	Direct-acting Diaphragm	Cold and hot water	SCS14A	1.0 or less	0.02-0.5	5-90°C	○	○	JIS 10KFF	15-25A	Stainless steel-made wetted parts 	I-78
	GD-43N-10											2.0 or less	
	GD-43-20				2.0 or less	JIS 20KRF	Stainless steel-made wetted parts 						
GD-43N-20	2.0 or less						JIS 20KRF	Stainless steel-made wetted parts 					
		GD-6	Direct-acting	Air, Cold and hot water, Oil	FCD450	1.0 or less		0.02-0.4	5-80°C	○	○	JIS Rc	10-25A
	SCS13												
	GD-7	Direct-acting Piston	Cold and hot water Oil	FC200	0.1-1.0	0.05-0.7	5-80°C	○	○	JIS 10KFF	20-150A	No-leakage type	I-84
	GD-7B												I-87
	GD-8N	Direct-acting Diaphragm	Pure water, Cold and hot water, Air Carbon dioxide gas, Nitrogen gas, Argon gas	SUS316	0.1-1.0	0.05-0.7	5-60°C	○	○	JIS Rc	6-15A	Clean regulator	I-92
	GP-50	Pilot	Cold and hot water	FC200	0.14-1.0	0.07-0.7	0-70°C	○	○	JIS 10KFF	125-300A	Large size, Large capacity	I-93

* Please contact us for fluid applications or connections other than above.

Pressure Reducing Valve (for Air/ for Water) ID-Charts

	Model	Type	Fluid	Body material	Inlet press. (MPa)	Reduced press. (MPa)	Max. temp. (°C)	Piping		Connection	Nominal size	Features	Page		
								Vertical	Horizontal						
	GD-400	Direct-acting Diaphragm	Air, Nitrogen gas	FC200	2.5-400 (kPa)	0.5-20 (kPa)	5-60°C			O	JIS 10KFF	15-50A	Extremely low pressure Best choice for tank seal	1-105	
	GD-400SS			SCS14									Stainless steel-made wetted parts	1-105	
	GD-4	Direct-acting Diaphragm	Air	FC200	300 kPa or less *500 kPa or less for 65A to 150A	2-200 (kPa)	5-80°C			O	JIS 10KFF	15-150A	Extremely low pressure	1-109	
	GD-4B				800 kPa or less								1-112		
	GP-1000T	Pilot-operated Piston	Air	FCD450	0.1-1.0	0.05-0.9	5-80°C			O	JIS 10KFF	15-100A	GP-1000 for air application	1-100	
	GP-1000TS													JIS Rc	15-50A
	GP-1200T	Pilot-operated Piston	Air	FCD450	0.1-1.0	0.05-0.9	5-80°C			O	JIS 10KFF	15-100A	Remote control by air pressure	1-100	
														GP-1210T	JIS Rc
	GP-1000TSS	Pilot-operated Piston	Air	SCS13	0.1-1.0	0.05-0.9	5-80°C			O	JIS 10KFF	15-50A	GP-1000T with stainless steel-made wetted parts	1-101	
	GP-1000TAS												GP-1000T of stainless steel-made		
	GD-41G	Direct-acting Diaphragm	Air, Carbon dioxide gas, Nitrogen gas	SCS14A	0.07-2.0	0.02-0.5	5-90°C				JIS Rc	15-25A	Compact and lightweight stainless steel-made wetted parts	1-80	
					GD-43G-10								0.07-1.0	JIS 10KFF	15-25A
	GD-43G-20				0.07-2.0						JIS 20KRF				
	GD-9N	Direct-acting Diaphragm	Air	ADC	0.1-1.0	8-20A; 0.05-0.7 25A; 0.05-0.85	5-60°C			O	O	JIS Rc	8-25A	For air application for instrument With handle for set pressure adjustment	1-115

* Please contact us for fluid applications or connections other than above.

Sizing for Pressure Reducing Valve

Step
2

■ Calculation Formula for Cv Value

(1) For steam

$$\text{When } P_2 > \frac{P_1}{2} \quad C_v = \frac{Wk}{138 \sqrt{\Delta P(P_1 + P_2)}}$$

$$\text{When } P_2 \leq \frac{P_1}{2} \quad C_v = \frac{Wk}{120P_1}$$

(2) For gas

$$\text{When } P_2 > \frac{P_1}{2} \quad C_v = \frac{Q}{2940} \frac{\sqrt{(273+t)G}}{\sqrt{\Delta P(P_1 + P_2)}}$$

$$\text{When } P_2 \leq \frac{P_1}{2} \quad C_v = \frac{Q \sqrt{(273+t)G}}{2550P_1}$$

(3) For liquid

$$C_v = \frac{0.365V \sqrt{G}}{\sqrt{\Delta P}}$$

W : Max. steam flow rate [kg/h]

P₁ : Inlet pressure [MPa·A]P₂ : Outlet pressure [MPa·A]ΔP : P₁ - P₂ [MPa]

k : 1 + 0.0013 × [superheated steam temperature [°C] - saturated steam temperature [°C]]

Q : Max. gas flow rate [m³/h (standard condition)]

G : Specific gravity (relative to air for gas, or relative to water for liquid)

t : Fluid temperature [°C]

V : Max. liquid flow rate [m³/h]

Cv : Cv value of each nominal size

Iv : Viscosity index

Mst: Viscosity [cSt]

■ Formula for Correction of Viscosity

$$I_v = \frac{72780}{Mst} \left(\frac{\Delta P}{G} \right)^{\frac{1}{2}} V^{\frac{1}{2}}$$

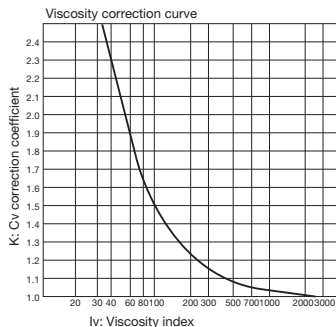

■ Cv Value Table





Model	Nominal size																			
	6A	8A	10A	15A	20A	25A	32A	40A	50A	65A	80A	100A	125A	150A	200A	250A	300A			
GPR-2000 screwed					5.0	7.2	10.9	14.3	18.8	32										
GPK-2001-2003 screwed					5.0	7.2	10.9	14.3	18.8	32	54	70	108	(112)	(225)	(234)				
GP-2000 flanged-GP-2000CS					5.0	7.2	10.9	14.3	18.8	32	54	70	108							
GPK-2001-2003 flanged					5.0	7.2	10.9	14.3	18.8	32	54	70	108							
GDK-2000					5.0	7.2	10.9	14.3	18.8	32	54	70	108							
GP-1000-1000T Series					1.0	2.3	4	6.5	9	16	25	36	64							
GP-27														100	144	230				
GD-6-6N				0.35	0.5	1.0	1.5													
GD-4					1.5	2	3	4	5	8	21	27	42	72	94					
GD-4B					1.5	2	3	4	5	8	12	16	24	36	48					
GD-400 (NBR)					1.5	2.0	3.0	5.0	6.0	8.0										
GD-400SS (NBR)					1.5	2.0	3.0	5.0	6.0	7.5										
GD-400 (FKM)					1.5	2.0	3.0	5.0	6.0	6.5										
GD-400SS (FKM)					1.5	2.0	3.0	5.0	6.0	6.0										
GD-7						2	3	6	8	15	23	30	40	50	60					
GD-7B						2	3	4	5	8	12	16	20	25	30					
GP-50																				
GD-8N		0.1	0.1	0.2	0.2									180	260	470	710			
GD-9N			0.15	0.2	0.5	0.7	1.2													
GD-200-200C-200H					2.5	4	5	8	12	16	28	36	68	75	108					
GD-24GS-24GS-N					1.5	1.9	3	4	7	10										
GD-26-NE-28-NE-26G					2	2.3	3.5	6	7	11										
GD-27-NE-29-NE-27G								3.5	6	7	11	21	26	38						
GD-26S-26S-NE-28S-26GS						2.3	3.5	6	7	11										
GD-27S-27S-NE-29S-27GS						2.3	3.5	6	7	11	21	26	38							
GD-41-43-41G-43G					0.4	0.6	0.8													

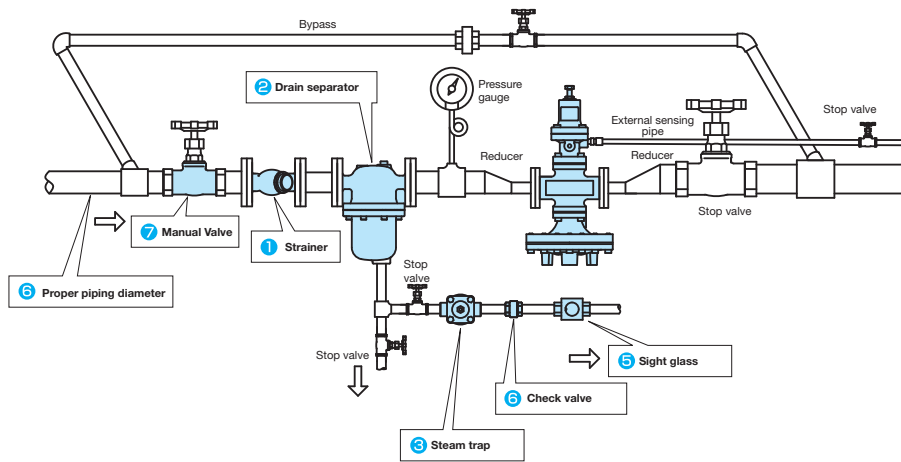

* The above values in parentheses are the Cv values of GP-2000 flanged only.

Guidelines for Pressure Reducing Valve for Steam





Please refer to this guidelines and confirm the adequacy for the optimum use of the pressure reducing valves for steam.



1 Strainer	
The strainer is installed in order to prevent the problems in the steam system attributable to scale. 80 mesh size is recommended for steam. Install it with its cap or cover for screen sideways so that the condensate accumulation is minimized.	
	SY-5 FCD450 Screwed (10-50A) Max 2.0 MPa
	SY-40 FCD450 Flanged (15-300A) Max 1.0 MPa
	SY-17 SCS13 Screwed (15-50A) Max 2.0 MPa
	SY-8 SCS13 Screwed (15-150A) Max 1.0 MPa
See Block 2.	

2 Drain separator	
The drain separator efficiently separates condensate and assures that dry and clean steam is supplied to the system. It also separates scale and contributes in increasing the durability of the pressure reducing valve.	
	DS-1 FCD450 Screwed (15-50A) Max 2.0 MPa
	DS-2 FCD450 Flanged (15-150A) Max 2.0 MPa
See Block 2.	

6 Check valve	
The check valve prevents condensate back flow.	
	SCV-2 Screwed (15-50A, Except 32A)
See Block 6.	

3 Steam trap	
The steam trap promptly discharges condensate and assures the condensate separated by the drain separator.	
	TSF-10-11 FCD450 Screwed (10-50A) Max 2.1 MPa
Float type	
	TB-20-20F FCD450 Screwed (15-25A) Max 2.0 MPa
Bucket type	
	TD-10NA FCD450 Screwed (15-25A) Max 2.0 MPa * Please use disc type for a possible freezing place.
See Block 3.	
7 Manual Valve	
	BSV-10F-20F FCD450 (Up to 100A) FCD400 equivalent (Above 100A) MAX2.8 MPa.
See Block 2.	

Step
3

• Safety valve set pressure for alarm use at the outlet side of steam pressure reducing valve

Pressure reducing valve set pressure (MPa)	Safety valve set pressure (MPa)
0.1 or less	Pressure reducing valve set pressure + 0.05 or more
Over 0.1 up to 0.4	Pressure reducing valve set pressure + 0.08 or more
Over 0.4 up to 0.6	Pressure reducing valve set pressure + 0.1 or more
Over 0.6 up to 0.8	Pressure reducing valve set pressure + 0.12 or more
Over 0.8	Pressure reducing valve set pressure + 15%

- When a safety valve is installed at the outlet side of a steam pressure reducing valve for alarm use and there are no laws or regulations applied, select a safety valve whose blowout capacity is around 10% of the maximum flow rate of the pressure reducing valve.



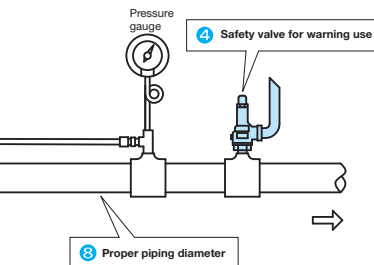

Precautions during installation

- When installing a safety valve at the pressure reducing valve outlet for the purpose of equipment protection, install an exhaust pipe at safety valve outlet and lead it to a place where there is no risk of physical damage even if steam blows out.
*Failure to follow this notice may result in injury and scald in case of steam blow out.
- Do not disassemble the pressure reducing valve unless necessary.
*Failure to follow this notice may prevent the pressure reducing valve from functioning properly.
- Install a strainer (80 mesh), drain separator, and a trap at the inlet side of the pressure reducing valve.
*Condensate or foreign substances may hinder proper operation of pressure reducing valve.
- Be sure to install pressure gauges at the inlet and outlet sides of the pressure reducing valve.
*Failure to follow this notice hinders proper pressure adjustment.
- When installing solenoid valves or other devices which open and close abruptly, they should be installed before pressure reducing valve at a proper distance (3 meters or more).
*Failure to follow this notice may result in malfunction or shortened service life.
- When pressure reducing in two stages, secure at least 3 meters between the pressure reducing valves.
*Failure to follow this notice may result in malfunction and hinder proper operation.
- When installing a control valve at the outlet side of a pressure reducing valve, secure as long distance as possible between the control valve and the pressure reducing valve. (at least 1 m for nominal size of 100A, at least 1.5 m for nominal size of 125A)
- Install a valve in proper direction of the fluid flow.
*Failure to follow this notice prevents the valve from functioning properly.
- Do not apply excessive load, torque, or vibration to the pressure reducing valve.
*Failure to follow this notice may result in malfunction or shortened service life.
- Install a pressure reducing valve vertically to horizontal piping.
- Equip a pressure reducing valve with a by-pass line.





4 Safety valve set pressure for alarm use

The safety valve for alarm use is safety equipment that prevents troubles caused by abnormal rise in reduced pressure of pressure reducing valve.

	AL-150 Lift type CAC406 Screwed (15-50A) For alarm use
	AL-31 Lift type SCS13 Flanged (15-50A) For alarm use
	AF-5 Full bore type CAC406 Screwed 20-50A For equipment protection
See Block 3.	

5 Sight glass

Effect of steam trap operation can be visually checked through sight glasses. For steam condensate application, use the product with mica plates to protect the glasses.

	SFM-1S FCD450 Screwed (15-50A) Flap type
	SFM-1F FCD450 Flanged (15-50A) Flap type
See Block 7.	

8 Proper piping diameter

One of the essentials for optimizing a steam line is to select a proper piping diameter. Stable pressure and flow rate are not assured without a correct size of piping even if the appropriate pressure reducing valve is selected.

Ex.) $P_1 = 1.0 \text{ MPa}$ $P_2 = 0.1 \text{ MPa}$ Steam flow rate 250 kg/h

Inlet piping diameter : 25A

Pressure reducing valve: Model GP-2000 15A

Outlet piping diameter : 50A

Steam Flow Rate Table (Saturated steam, Flow velocity 30 m/s, Carbon steel pipe) (kg/h)

Pressure MPa \ Nominal size	15A	20A	25A	32A	40A	50A
	0.05	18	33	55	92	125
0.1	24	44	72	120	164	265
0.2	35	64	105	176	240	388
0.3	47	84	138	231	314	508
0.4	58	104	170	285	387	627
0.5	69	124	202	339	460	745
0.6	79	143	234	392	533	862
0.7	90	163	266	445	605	978
0.8	101	182	297	498	676	1094
0.9	112	201	329	551	748	1209
1.0	122	220	360	603	819	1325

See Block 20-13 "Flow Velocity Table for Steam inside the Pipe."

Pressure Reducing Valve for Steam

Example of Two-stage reduction

For most of applications, only one Yoshitake pressure reducing valve is enough to control the flow, because max. pressure reduction ratio of the most Yoshitake pressure reducing valves is 20:1.

Two-stage reduction is applied for assuring more safety, in addition to the case where the ratio exceeds 20:1. Taking an example of a line where pressure is reduced from 1 MPa to 0.05 MPa, the line with only one pressure reducing valve is subjected to 1 MPa of steam when the valve malfunctions. However, a line with two-stage reduction, where the steam pressure is reduced from 1 MPa to 0.2 MPa by the first pressure reducing valve and then reduced to 0.05 MPa by the second one, is assured to be safe when the first valve fails. Even when the second one malfunctions, the trouble will be lessened because the reduced pressure rise will be up to 0.2 MPa.

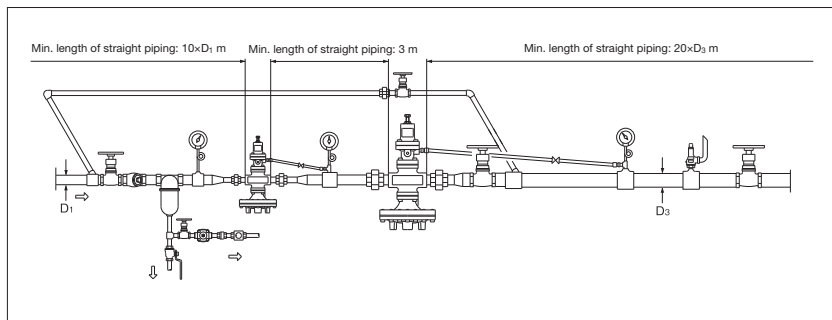

Example of parallel reduction

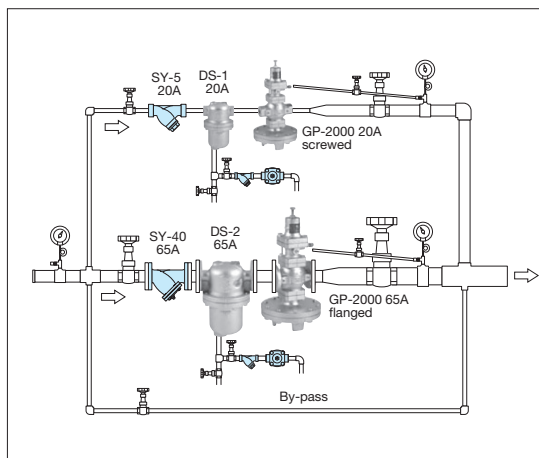

Advantage of parallel installation

- Wider control range of flow rate is achieved.
Easy to change flow rate according to required steam amount.
- Risk is mitigated in a steam plant.
Steam can be supplied if at least one pressure reducing valve works well even if the other malfunctions.
- Piping work will be easier when the required steam amount increases.

How to set the pressure

The set pressures of the two pressure reducing valves have to be different by the same value as the rated offset or 0.03 to 0.05 MPa. This is because the vibration is amplified when the two valves have the same set pressures, that is, they have the same vibration period. Please use one pressure reducing valve for small flow rate, and two for large flow rate, for normal operations.

Air-loaded Pressure Reducing Valve (for Steam)

Step
3

Standard piping example

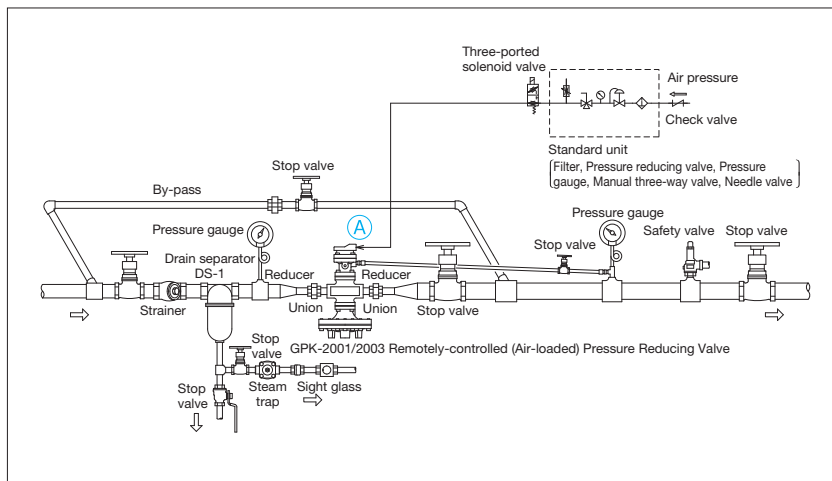

Remotely-controlled pressure reducing valve can be used at more than one set pressures by combining air pressures which are controlled by a solenoid valve.

■Standard unit line

Ideal set pressure can be obtained by controlling air pressure reduced by the pressure reducing valve at standard unit. The air can be on/off by a manual three-way valve.

If a three-way solenoid valve is used, the air can be on/off controlled automatically.

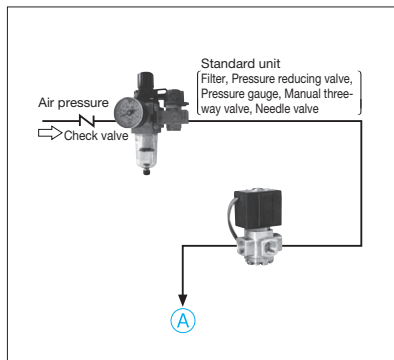

■Combination unit line

By switching air pressures from two different standard units, the remotely-controlled pressure reducing valve can be used at two different set pressures.

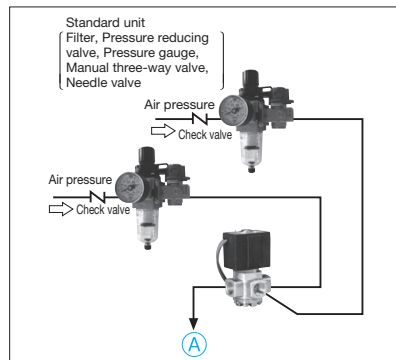

Guidelines for Pressure Reducing Valve for Liquid

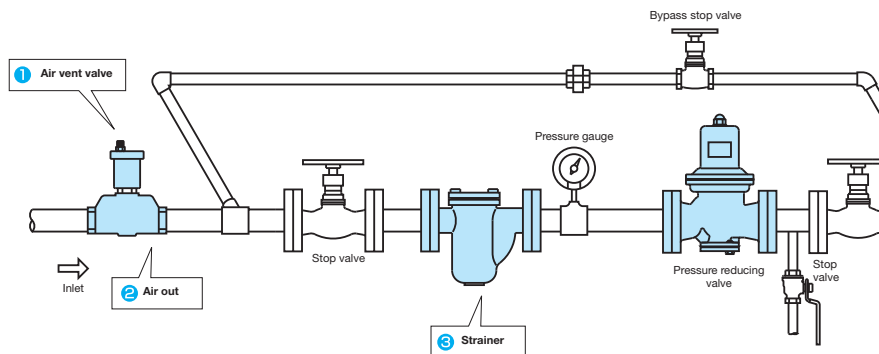

1 Air vent valve

The air in the piping system causes noise and unstable pressure. The air vent valve is installed to effectively discharge the air in the system.



TA-3
FCD450
(Electrodeposition coating)
Screwed (15-32A)
Max. 1.0 MPa



TA-16
SCS13
Screwed (15-25A)
Product complying
comply of Japan Water
Works Association

See Block 14.

2 Air out

The air out is used to continuously separate the air from the liquid.



AO-2
CAC406
Screwed (15-50A)
Max. 1.0 MPa

See Block 10.

3 Strainer

The strainer is installed to prevent troubles caused by scale. The mesh size of 60 or more is recommended for a cold/hot water line.



SU-20
FCD450
Basket strainer
Flanged (20-150A)



SY-24
CAC406
Y-type strainer
Screwed (15-50A)



SW-10
FCD450
Duplex strainer
Flanged (20-100A)

See Block 11.

4 Safety valve (Relief valve)

The safety valve is a safety equipment to prevent troubles caused by abnormal increase in reduced pressure of the pressure reducing valve.



AL-150T
CAC406
Lift type
Screwed (15-50A)



AL-300T
FCD450
Lift type
Flanged (15-50A)



AL-260R
CAC406
Pump relief valve
Screwed (15-50A)

See Block 12.

Step
3

· Safety valve set pressure for alarm use at the outlet side of water pressure reducing valve



Pressure reducing valve set pressure (MPa)	Safety valve (relief valve) set pressure (MPa)
0.1 or less	Pressure reducing valve set pressure + 0.05 or more (0.08 or more)
Over 0.1 up to 0.4	Pressure reducing valve set pressure + 0.08 or more (0.12 or more)
Over 0.4 up to 0.6	Pressure reducing valve set pressure + 0.10 or more (0.16 or more)
Over 0.6 up to 0.8	Pressure reducing valve set pressure + 0.12 or more (0.21 or more)
Over 0.8	Pressure reducing valve set pressure + 15% (26% or more)

* When a safety valve is installed at the outlet side of a steam pressure reducing valve for alarm use and there are no laws or regulations applied, select a safety valve whose blowout capacity is around 10% of the maximum flow rate of the pressure reducing valve. Values for safety valves with soft seat is shown in parenthesis.

⚠ Precautions during installation

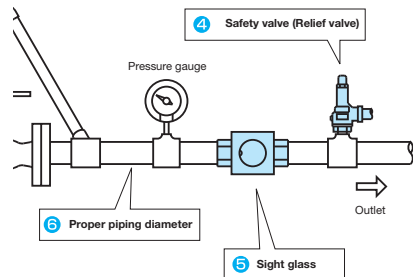
- Do not disassemble the pressure reducing valve unless necessary.
 - Failure to follow this notice may prevent the pressure reducing valve from functioning properly.
- Install a strainer (60 mesh) at the inlet side of the pressure reducing valve.
 - Foreign substances or scales may hinder proper operation of pressure reducing valve.
- Install a safety relief valve as alarm at the outlet side of the pressure reducing valve.
 - Failure to follow this notice may result in damage to the equipment.
- Be sure to install pressure gauges at the inlet and outlet sides of the pressure reducing valve.
 - Failure to follow this notice hinders proper pressure adjustment.
- When installing solenoid valves or other devices which open and close abruptly, they should be installed before pressure reducing valve at a proper distance (3 meters or more).
 - Failure to follow this notice may result in malfunction or shortened service life.
- When pressure reducing in two stages, secure at least 3 meters between the pressure reducing valves.
 - Failure to follow this notice may result in malfunction and hinder proper operation.
- Install a valve in proper direction of the fluid flow.
 - Failure to follow this notice prevents the valve from functioning properly.
- Do not apply excessive load, torque, or vibration to the pressure reducing valve.
 - Failure to follow this notice may result in malfunction or shortened service life.
- Install a pressure reducing valve vertically to horizontal piping.
- Equip a pressure reducing valve with a by-pass line.



5 Sight glass	
With the sight glass, the flow can be visually checked.	
	SB-1S FCD450 Screwed (15-50A) Ball type
	SF-1S FCD450 Screwed (15-50A) Flap type
	150F-13F SCS13 Flanged (15-150A) Flap type
See Block 7.	

6 Proper piping diameter

Cold/hot water is an incompressible fluid and it does not change in the volume by the change in pressure. The proper piping diameter is recommended to be determined at the flow velocity of 1-3 m/s. Serious problems such as water hammer may occur if the flow velocity is too high.

Water Flow Rate Table (Carbon steel pipe) (m³/h)





Flow velocity (m/s)	Nominal size					
	15A	20A	25A	32A	40A	50A
1.0	0.73	1.32	2.15	3.60	4.89	7.91
1.2	0.88	1.58	2.58	4.32	5.87	9.49
1.4	1.03	1.85	3.01	5.04	6.85	11.07
1.6	1.17	2.11	3.44	5.76	7.82	12.65
1.8	1.32	2.37	3.87	6.48	8.80	14.23
2.0	1.47	2.64	4.31	7.20	9.78	15.82
2.5	1.83	3.30	5.38	9.00	12.23	19.77
3.0	2.20	3.96	6.46	10.81	14.67	23.72

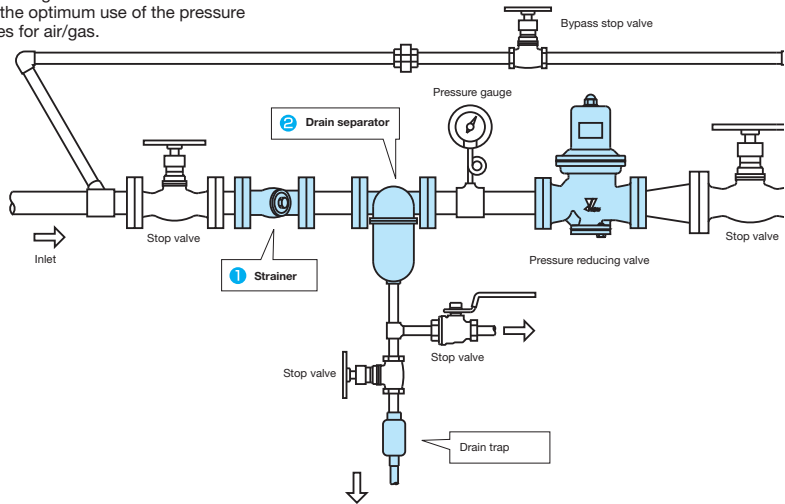

See Block 20-14 "Flow Velocity Table for Water inside the Pipe."

Guidelines for Pressure Reducing Valve for Air/Gas

Please refer to this guidelines and confirm the adequacy for the optimum use of the pressure reducing valves for air/gas.



1 Strainer	
The strainer is installed to prevent troubles in the air/gas system attributable to scale. The mesh size of 60 or more is recommended. Install it with its cap or cover for screen sideways as shown in the figure so that the drain accumulation is minimized.	
	SY-5 FCD450 Screwed (10-50A) Max 2.0 MPa
	SY-40 FCD450 Flanged (15-300A) Max 1.0 MPa
	SY-17 SCS13 Screwed (15-50A) Max 2.0 MPa
	SY-8 SCS13 Flanged (15-150A) Max 1.0 MPa
See Block 1	

2 Drain separator	
The condensate separator efficiently separates condensate and assures that dry and clean air/gas is supplied to the system. It also separates scale and contributes in increasing the durability of the pressure reducing valve.	
	DS-1 FCD450 Screwed (15-50A) MAX 2.0 MPa
	DS-2 FCD450 Flanged (15-150A) MAX 2.0 MPa
See Block 2	

* MAX 1.0 MPa for JIS10KFF, 10KRF, and for air application.

Step
3

Safety valve set pressure for alarm use at the outlet side of air/gas pressure reducing valve

Pressure reducing valve set pressure (MPa)	Safety valve set pressure (MPa)
0.1 or less	Pressure reducing valve set pressure + 0.05 or more (0.08 or more)
Over 0.1 up to 0.4	Pressure reducing valve set pressure + 0.08 or more (0.12 or more)
Over 0.4 up to 0.6	Pressure reducing valve set pressure + 0.10 or more (0.16 or more)
Over 0.6 up to 0.8	Pressure reducing valve set pressure + 0.12 or more (0.21 or more)
Over 0.8	Pressure reducing valve set pressure + 15% (26% or more)

* When a safety valve is installed at the outlet side of a steam pressure reducing valve for alarm use and there are no laws or regulations applied, select a safety valve whose blowout capacity is around 10% of the maximum flow rate of the pressure reducing valve. Values for safety valves with soft seat is shown in parenthesis.

⚠ Precautions during installation

- Do not disassemble the pressure reducing valve unless necessary.
 - * Failure to follow this notice may prevent the pressure reducing valve from functioning properly.
- Install a strainer (60 mesh) at the inlet side of the pressure reducing valve.
 - * Foreign substances or scales may hinder proper operation of pressure reducing valve.
- Install a safety relief valve as alarm at the outlet side of the pressure reducing valve.
 - * Failure to follow this notice may result in damage to the equipment.
- Be sure to install pressure gauges at the inlet and outlet sides of the pressure reducing valve.
 - * Failure to follow this notice hinders proper pressure adjustment.
- When installing solenoid valves or other devices which open and close abruptly, they should be installed before pressure reducing valve at a proper distance (3 meters or more).
 - * Failure to follow this notice may result in malfunction or shortened service life.
- When pressure reducing in two stages, secure at least 3 meters between the pressure reducing valves.
 - * Failure to follow this notice may result in malfunction and hinder proper operation.
- Install a valve in proper direction of the fluid flow.
 - * Failure to follow this notice prevents the valve from functioning properly.
- Do not apply excessive load, torque, or vibration to the pressure reducing valve.
 - * Failure to follow this notice may result in malfunction or shortened service life.
- Install a pressure reducing valve vertically to horizontal piping.
- Equip a pressure reducing valve with a by-pass line.

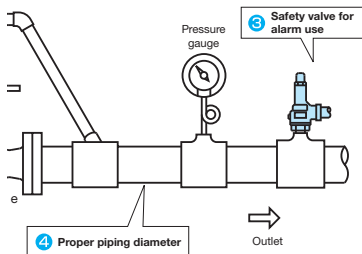

3 Safety valve for alarm use

The safety valve for alarm use is safety equipment that prevents troubles caused by the abnormal increase in reduced pressure of the pressure reducing valve.



AL-150T

Lift type CAC406
Screwed (15-50A)
For alarm use



AL-300T

Lift type FCD450
Flanged (15-50A)
For alarm use

See Block 3.

4 Proper piping diameter

One of the essentials for optimizing an air/gas line is to select a proper piping diameter. Stable pressure and flow rate are not assured without a correct size of piping even if the appropriate pressure reducing valve is selected.

Ex.) $P_1 = 0.7 \text{ MPa}$ $P_2 = 0.1 \text{ MPa}$ Air flow rate 250 kg/h

Inlet piping diameter : 25A

Pressure reducing valve : Model GD-26G 20A

Outlet piping diameter : 50A

Air Flow Rate Table (Flow velocity 15 m/s, $t = 20^\circ\text{C}$ Carbon steel pipe) (kg/h)

Pressure MPa	Nominal size					
	15A	20A	25A	32A	40A	50A
0.1	26	47	77	129	175	283
0.2	39	70	115	193	263	425
0.3	52	94	154	258	350	567
0.4	65	118	192	322	438	708
0.5	78	141	231	387	526	850
0.6	91	165	270	451	613	992
0.7	105	189	308	516	701	1134
0.8	118	212	347	581	789	1275
0.9	131	236	385	645	876	1417
1.0	144	260	424	710	964	1559

See Block 20-14 "Flow Velocity Table for Air inside the Pipe."

GP-2000/GP-2000EN

Direct type	Pilot type	Piston	Diaphragm
Bellows	Internal sensing	External sensing	Stainless steel
With handle	Built-in strainer	Low pressure	Remote
Valve leakage 0	Nylon		



Screwed type



Flanged type

■Features

1. Large-size diaphragm and external sensing method control reduced pressure more stably.
2. Since the Cv value is high, flow capability and control capability are significantly improved, one or two sizes smaller than the regular nominal size can be applied.
3. Spherical main valve offers great sealability and great reduction of valve seat leakage (compliant with ANSI Class IV).
4. Pressure management at low pressure (0.02 MPa or less) is available. (GP-2000L)²

■Specifications

Model		GP-2000		GP-2000EN
Application		Steam		
Reduced pressure sensing method		External sensing *1		
Inlet pressure		0.1-2.0 MPa	0.1-1.0 MPa	0.1-2.0 MPa
Reduced pressure		0.02-0.15 MPa	0.02-0.15 MPa *2	0.02-0.15 MPa
		0.1-1.4 MPa *2	0.1-0.85 MPa *2	0.1-1.4 MPa
		1.3-1.7 MPa		1.3-1.7 MPa
Minimum differential pressure		85% or less of inlet pressure (gauge pressure)		
Maximum pressure reduction ratio		0.05 MPa		
Maximum temperature		20:1		
Valve seat leakage		220°C		
Valve seat leakage		0.01% or less of rated flow		
Material	Body	Ductile cast iron		
	Main valve	Stainless steel		
	Valve seat	Stainless steel		
	Pilot valve	Stainless steel		
	Pilot valve seat	Stainless steel		
	Diaphragm	Stainless steel		
Reduced pressure sensing pipe		Copper pipe φ8-2 m		
Connection		JIS Rc screwed	JIS 20K RF flanged	JIS 10K FF flanged EN PN25 flanged

*1 External sensing is standard. When installing the pressure reducing valve, be sure to connect the provided sensing pipe and joint. Unless the sensing pipe is connected, the valve will not operate.

(Available with internal sensing type (nominal size: 15A to 100A) in different specifications. Note that Cv value of internal sensing type is lower than that of external sensing type.)

*2 Available with the GP-2000L, reduced pressure of 0.01 to 0.02 MPa, from 15A to 100A, inlet pressure of 0.1 to 0.5 MPa and maximum pressure reduction of 50:1.

· Available with external pilot type.

· Available with ASME flanged.

■ Dimensions (mm) and Weights (kg)

· Screwed type

Nominal size	d	L	H ₁	H	A	Weight
15A	Rc 1/2	150	170	398	200	14.0
20A	Rc 3/4	150	170	398	200	14.0
25A	Rc 1	160	175	404	226	18.5
32A	Rc 1-1/4	180	192	434	226	21.5
40A	Rc 1-1/2	180	192	434	226	21.5
50A	Rc 2	230	216	498	276	33.0

* Available with NPT connection.

· Flanged type (JIS 20K RF)

Nominal size	L	H ₁	H	A	Weight
15A	146 (142)	170	398	200	15.5 (15.3)
20A	146 (142)	170	398	200	16.0 (15.8)
25A	156 (152)	175	404	226	21.0 (20.6)
32A	176 (172)	192	434	226	24.0 (23.6)
40A	196 (192)	192	434	226	24.5 (24.1)
50A	222 (218)	216	498	276	36.0 (35.8)
65A	282 (278)	251	552	352	64.5 (64.2)
80A	302 (294)	264	575	352	71.5 (68.8)
100A	342 (330)	321	658	401	111.0 (106.9)
125A	400 (388)	321	658	401	115.0 (112.0)
150A	465 (453)	414	814	502	234.3 (230.0)
200A	469 (469)	414	814	502	242.0 (238.0)

* The above values in parentheses are the dimensions of JIS 10K FF flanged.

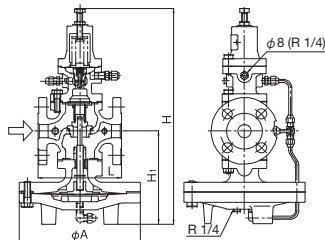
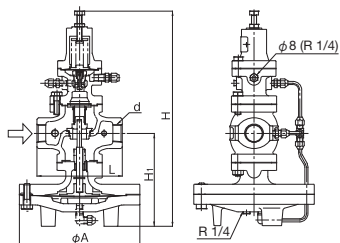

Manual Set Point Type Remote Control (Maximum distance of 5 meters)

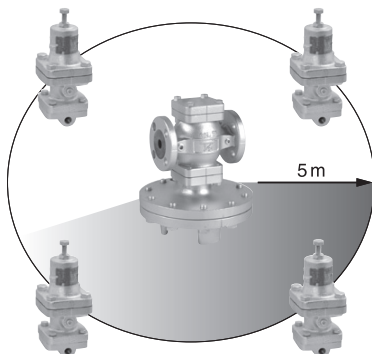

Piping Example

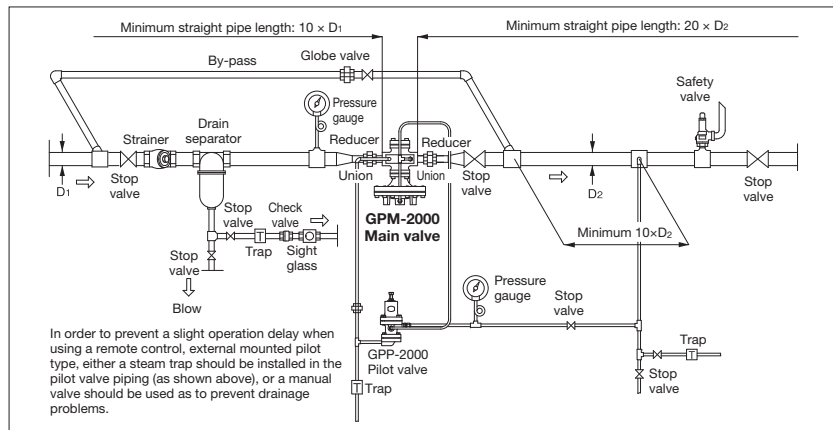

Variation



GPP-2000 pilot valve

GPM-2000 main valve
(screwed)GPM-2000 main valve
(flanged)

■GP-2000 Flow Rate Table

(kg/h)

P ₁ (MPa)	P ₂ (MPa)	15A	20A	25A	32A	40A	50A	65A	80A	100A	125A	150A	200A
2.0	0.1-0.9	1,260	1,814	2,746	3,603	4,737	8,064	13,608	17,640	27,216	28,224	56,700	58,968
	1	1,232	1,775	2,687	3,525	4,634	7,889	13,330	17,280	26,661	27,648	55,543	57,765
	1.2	1,136	1,636	2,477	3,250	4,273	7,273	12,290	15,931	24,580	25,490	51,208	53,257
	1.4	1,012	1,458	2,207	2,896	3,808	6,481	10,952	14,197	21,904	22,715	45,633	47,459
1.8	0.1-0.8	1,140	1,641	2,485	3,260	4,286	7,296	12,312	15,960	24,624	25,536	51,300	53,352
	0.9	1,113	1,603	2,426	3,183	4,185	7,125	12,039	15,606	24,078	24,969	50,162	52,169
	1	1,067	1,537	2,327	3,053	4,014	6,832	11,544	14,965	23,089	23,944	48,102	50,026
	1.2	954	1,374	2,081	2,730	3,590	6,111	10,325	13,385	20,651	21,416	43,024	44,745
1.6	0.1-0.7	1,020	1,468	2,223	2,917	3,835	6,528	11,016	14,280	22,032	22,848	45,900	47,736
	1	893	1,286	1,947	2,554	3,358	5,716	9,658	12,520	19,317	20,033	40,245	41,855
	1.3	664	956	1,448	1,900	2,498	4,253	7,186	9,315	14,378	14,905	29,943	31,141
1.4	0.1-0.6	900	1,296	1,962	2,574	3,384	5,760	9,720	12,600	19,440	20,160	40,500	42,120
	1	702	1,011	1,531	2,009	2,642	4,497	7,599	9,851	15,199	15,762	31,664	32,931
	1.1	620	893	1,352	1,773	2,331	3,969	6,706	8,694	13,413	13,910	27,945	29,062
1.2	0.1-0.5	780	1,123	1,700	2,230	2,932	4,992	8,424	10,920	16,848	17,472	35,100	36,504
	1	477	687	1,040	1,365	1,795	3,055	5,162	6,692	10,325	10,708	21,512	22,372
1.0	0.1-0.4	660	950	1,438	1,887	2,481	4,224	7,128	9,240	14,256	14,784	29,700	30,888
	0.5	635	914	1,385	1,817	2,388	4,066	6,870	8,906	13,740	14,249	28,626	29,771
	0.8	435	627	950	1,246	1,638	2,789	4,713	6,109	9,426	9,775	19,637	20,423
0.9	0.1-0.4	600	864	1,308	1,716	2,256	3,840	6,480	8,400	12,960	13,440	27,000	28,080
	0.5	551	793	1,201	1,576	2,072	3,528	5,961	7,728	11,923	12,364	24,840	25,833
	0.7	413	595	901	1,182	1,554	2,646	4,471	5,796	8,942	9,273	18,630	19,375
0.8	0.1-0.3	540	777	1,177	1,544	2,030	3,456	5,832	7,560	11,664	12,096	24,300	25,272
	0.5	462	665	1,007	1,322	1,738	2,958	4,998	6,480	9,997	10,368	20,828	21,662
0.7	0.1-0.3	480	691	1,046	1,372	1,804	3,072	5,184	6,720	10,368	10,752	21,600	22,464
	0.5	364	525	794	1,042	1,371	2,333	3,943	5,111	7,886	8,178	16,430	17,087
0.6	0.1-0.2	420	604	915	1,201	1,579	2,688	4,536	5,880	9,072	9,408	18,900	19,656
	0.3	395	570	862	1,132	1,488	2,533	4,280	5,549	8,561	8,878	17,836	18,550
	0.5	248	357	541	710	934	1,590	2,686	3,482	5,373	5,572	11,195	11,643
0.5	0.1-0.2	360	518	784	1,029	1,353	2,304	3,888	5,040	7,776	8,064	16,200	16,848
	0.3	308	443	671	881	1,158	1,972	3,332	4,320	6,665	6,912	13,885	14,441
	0.4	228	329	498	653	859	1,462	2,471	3,203	4,943	5,126	10,298	10,710
0.4	0.05-0.15	300	432	654	858	1,128	1,920	3,240	4,200	6,480	6,720	13,500	14,040
	0.3	206	297	450	591	777	1,323	2,235	2,898	4,471	4,636	9,315	9,687
0.3	0.05-0.1	240	345	523	686	902	1,536	2,592	3,360	5,184	5,376	10,800	11,232
	0.2	182	262	397	521	685	1,166	1,971	2,555	3,943	4,089	8,215	8,543
0.2	0.05	180	259	392	515	677	1,152	1,944	2,520	3,888	4,032	8,100	8,424
	0.1	154	221	335	440	579	986	1,666	2,160	3,332	3,456	6,942	7,220
0.1	0.05	91	131	198	260	342	583	985	1,277	1,971	2,044	4,107	4,271

GPK-2001,2003

Direct type	Pilot type	Piston	Diaphragm
Bellows	Internal sensing	External sensing	Stainless steel
With handle	Built-in strainer	Low pressure	Remote
Valve leakage 0	Nylon		

■Features

- Superior to piston type valve in capacity and performance. Very effective in controlling inlet pressure and flow rate fluctuations.
- Spherical main valve offers great sealability and great reduction of valve seat leakage (compliant with ANSI Class IV).
- Remote control makes pressure adjustment easy, and the pressure setting is wide.
- The GPK-2001 and GPK-2003 can be selected according to the loading air pressure.



GPK-2001
screwed type



GPK-2003
flanged type

■Specifications

Model	GPK-2001	GPK-2003
Application	Steam	
Reduced pressure sensing method	External sensing *	
Inlet pressure	JIS Rc JIS 20K RF	0.1-2.0 MPa
	JIS 10K FF	0.25-2.0 MPa
Reduced pressure	0.1-1.0 MPa	0.25-1.0 MPa
	0.05-0.9 MPa (0.85 MPa for JIS 10K) 0.2-1.4 MPa (0.85 MPa for JIS 10K)	
Loading air pressure	85% or less of inlet pressure (gauge pressure)	
Minimum differential pressure	Refer to the loading air pressure-set pressure chart.	
Maximum pressure reduction ratio	20:1	10:1
Maximum temperature	220°C	
Valve seat leakage	0.01% or less of rated flow	
Material	Body	Ductile cast iron
	Main valve	Stainless steel
	Valve seat	Stainless steel
	Pilot valve	Stainless steel
	Pilot valve seat	Stainless steel
	Diaphragm	Stainless steel
Reduced pressure detection pipe	Copper pipe ϕ 8-2 m	
Connection	JIS Rc screwed JIS 20K RF and 10K FF flanged	

* External sensing is standard. When installing the pressure reducing valve, be sure to connect the provided sensing pipe and joint. Unless the sensing pipe is connected, the valve will not operate.

(Available with internal sensing type in different specifications. Note that the Cv value of internal sensing type is lower than that of external sensing type.)

· Available with ASME or EN flanged.

■For Pneumatic Circuit Operation

Please refer to P.1-18.

■ Dimensions (mm) and Weights (kg)

• GPK-2001 screwed type

Nominal size	d	L	H ₁	H	A	Weight
15A	Rc 1/2	150	170	335	200	14.0
20A	Rc 3/4	150	170	335	200	14.0
25A	Rc 1	160	175	341	226	18.5
32A	Rc 1-1/4	180	192	371	226	21.5
40A	Rc 1-1/2	180	192	371	226	21.5
50A	Rc 2	230	216	435	276	33.0

* Available with NPT connection.

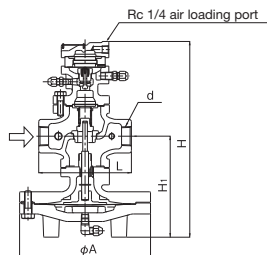

• GPK-2003 screwed type

Nominal size	d	L	H ₁	H	A	Weight
15A	Rc 1/2	150	170	353	200	17.5
20A	Rc 3/4	150	170	353	200	17.5
25A	Rc 1	160	175	359	226	22.0
32A	Rc 1-1/4	180	192	389	226	25.0
40A	Rc 1-1/2	180	192	389	226	25.0
50A	Rc 2	230	216	453	276	36.5

* Available with NPT connection.

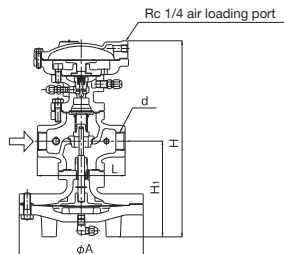

• GPK-2001 flanged type (JIS 20K RF)

Nominal size	L	H ₁	H	A	Weight
15A	146 (142)	170	335	200	15.5 (15.3)
20A	146 (142)	170	335	200	16.0 (15.8)
25A	156 (152)	175	341	226	21.0 (20.6)
32A	176 (172)	192	371	226	24.0 (23.4)
40A	196 (192)	192	371	226	24.5 (24.1)
50A	222 (218)	216	435	276	36.0 (35.8)
65A	282 (278)	251	489	352	64.5 (64.2)
80A	302 (294)	264	512	352	71.5 (69.3)
100A	342 (330)	321	595	401	111.0 (107.4)

* The above values in parentheses are the dimensions and weights of JIS 10K FF flanged.

• Please contact us for other specifications.

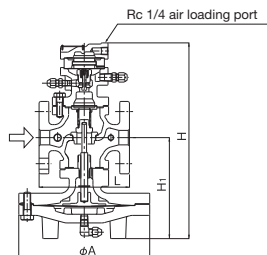

• GPK-2003 flanged type (JIS 20K RF)

Nominal size	L	H ₁	H	A	Weight
15A	146 (142)	170	353	200	19.0 (18.8)
20A	146 (142)	170	353	200	19.5 (19.3)
25A	156 (152)	175	359	226	24.5 (24.1)
32A	176 (172)	192	389	226	27.5 (27.1)
40A	196 (192)	192	389	226	28.0 (27.6)
50A	222 (218)	216	453	276	39.5 (39.3)
65A	282 (278)	251	507	352	68.0 (67.7)
80A	302 (294)	264	530	352	75.0 (72.8)
100A	342 (330)	321	613	401	114.5 (113.9)

* The above values in parentheses are the dimensions and weights of JIS 10K FF flanged.

• Please contact us for other specifications.

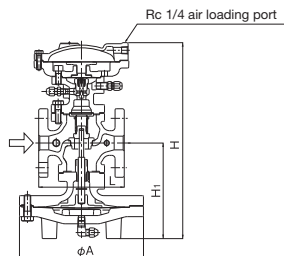

GDK-2000

Direct type	Pilot type	Piston	Diaphragm
Bellows	Internal sensing	External sensing	Stainless steel
With handle	Built-in strainer	Low pressure	Remote
Valve leakage 0	Nylon		

■Features

1. Due to direct acting type the actuating parts are fewer and structure is simple but robust.
2. Spherical main valve offers great sealability and great reduction of valve seat leakage (compliant with ANSI Class IV).
3. Large-size diaphragm ensures high Cv value and distinguished controllability against load fluctuations.
4. Remote operation makes pressure adjustment easy, and the pressure setting is wide.



Screwed type

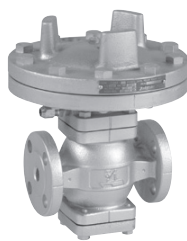

Flanged type

■Specifications

Model		GDK-2000	
Application		Steam	
Reduced pressure sensing method		External sensing *	
Inlet pressure		0.1-2.0 MPa	0.1-1.0 MPa
Reduced pressure		0.05-1.4 MPa	0.05-0.85 MPa
Operation air pressure		90% or less of inlet pressure (gauge pressure)	
Minimum differential pressure		0.05 MPa	
Maximum pressure reduction ratio		10:1	
Maximum temperature		220°C	
Valve seat leakage		0.01% or less of rated flow	
Material	Body	Ductile cast iron	
	Valve	Stainless steel	
	Valve seat	Stainless steel	
	Diaphragm	Stainless steel	
Reduced pressure sensing pipe		Copper pipe ϕ 8-2 m	
Connection		JIS Rc screwed	JIS 20K RF flanged
			JIS 10K FF flanged

* External sensing is standard. When installing the pressure reducing valve, be sure to connect the provided sensing pipe and joint. Unless the sensing pipe is connected, the valve will not operate.

· Available with ASME or EN flanged.

■ Dimensions (mm) and Weights (kg)

· Screwed type

Nominal size	d	L	H ₁	H	A	Weight
15A	Rc 1/2	150	74	244	200	12.4
20A	Rc 3/4	150	74	244	200	12.4
25A	Rc 1	160	76	251	226	16.4
32A	Rc 1-1/4	180	90	282	226	19.9
40A	Rc 1-1/2	180	90	282	226	19.9
50A	Rc 2	230	103	319	276	30.5

* Available with NPT connection.

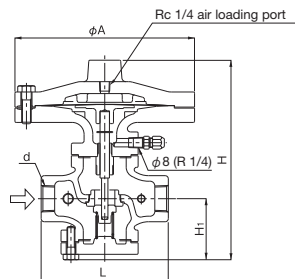

Screwed type

· Flanged type

Nominal size	L	H ₁	H	A	Weight
15A	146 (142)	74	244	200	13.9 (13.7)
20A	146 (142)	74	244	200	14.4 (14.2)
25A	156 (152)	76	251	226	19.2 (18.8)
32A	176 (172)	90	282	226	22.4 (22.0)
40A	196 (192)	90	282	226	22.9 (22.5)
50A	222 (218)	103	319	276	33.5 (33.5)
65A	282 (278)	122	373	352	61.8 (61.5)
80A	302 (294)	135	399	352	69.1 (66.9)
100A	342 (330)	167	488	401	108.6 (105.0)

* The above values in parentheses are the dimensions and weights of JIS 10K FF flanged.

· Please contact us about other specifications.

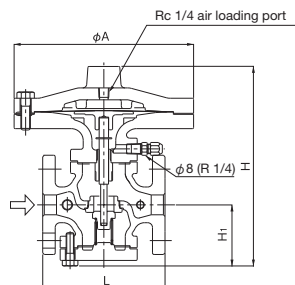

Flanged type

Specifications Selection Chart

· GP-2000, GPK-2001 · 2003

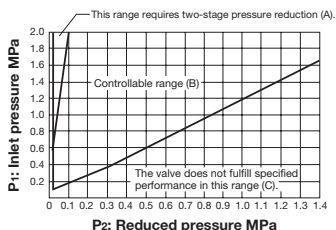

· GDK-2000

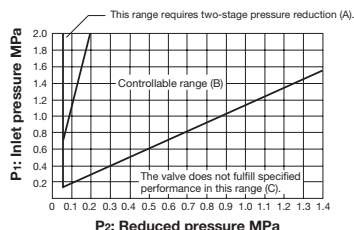

Please refer to the above selection chart to select the most appropriate pressure reducing valve. Find the point of intersection of inlet pressure (P_1) and reduced pressure (P_2). When the point of intersection is within range (A), reduce pressure in two stages. When within range (B), controllable range. When within range (C), maximum performance cannot be obtained. When reducing pressure in two stages, maximize the distance between the valves (at least 3 m).

■ Nominal Sizes Selection Chart for GP-2000 Series (For Steam/External Sensing)

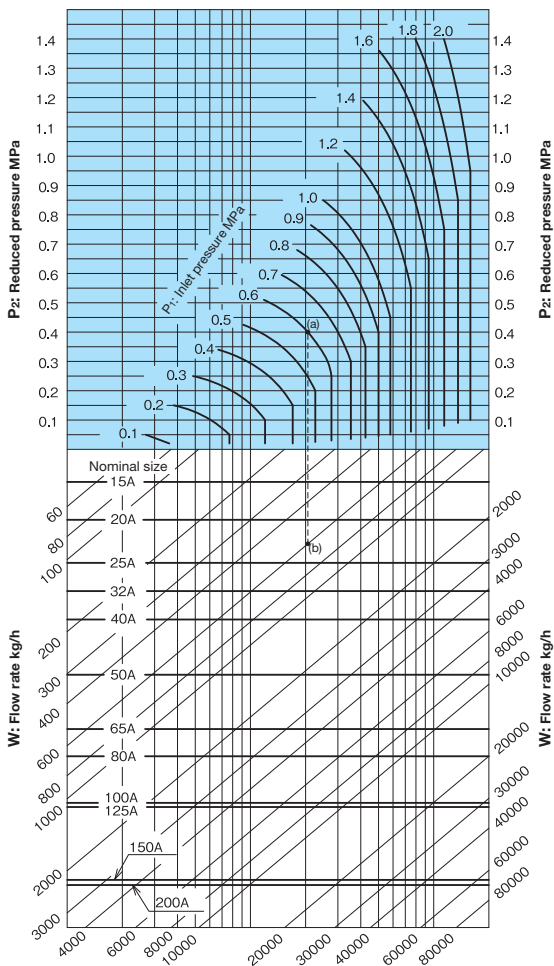

[Example]

When selecting the nominal size of a pressure reducing valve whose inlet pressure (P_1), reduced pressure (P_2), and flow rate are 0.6 MPa, 0.4 MPa, and 600 kg/h, respectively, first find intersection point (a) of the inlet pressure of 0.6 MPa and the reduced pressure of 0.4 MPa. Trace down vertically from this intersection point to find intersection point (b) with the flow rate of 600 kg/h. Since intersection point (b) lies between nominal sizes 20A and 25A, select the larger one, 25A.

- Set the safety factor at 80 to 90%.

Flow Characteristic Chart

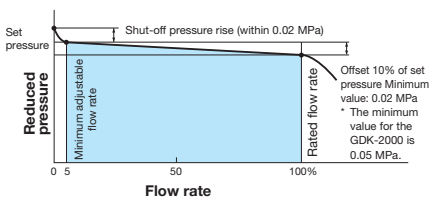

When selecting a nominal size, set the flow rate at 80 to 90% of the rated flow rate, allowing for the pressure loss and heat loss of the stop valve, strainer, etc. to be used before or after the pressure reducing valve. To enable the pressure reducing valve to show a maximum flow characteristic, do not select a small piping diameter, as a countermeasure against the effect of piping resistance. Select a nominal size based on the nominal sizes selection chart.

Pressure Characteristic Chart

GP-2000, GPK-2001 · 2003

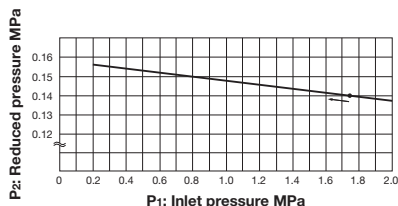

This chart shows variation in reduced pressure when the inlet pressure of 1.75 MPa is changed between 0.2 MPa and 2.0 MPa while the reduced pressure is set at 0.14 MPa.

GDK-2000

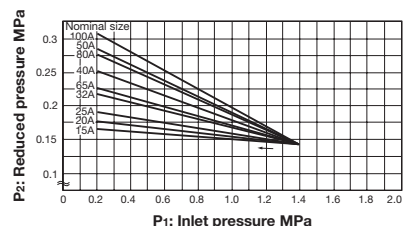

This chart shows variation in reduced pressure when the inlet pressure of 1.4 MPa is changed between 0.2 MPa and 1.4 MPa while the reduced pressure is set at 0.14 MPa.

Loading Air Pressure-set Pressure Chart

GP-2000, GPK-2001 · 2003

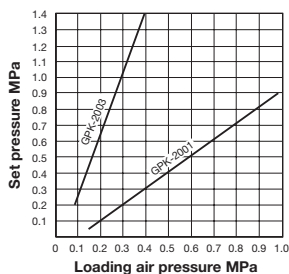

Basically, the set pressure to the loading air pressure is as shown in the chart above. The set pressure is slightly different depending on the working conditions. For the actual use, adjust loading air pressure suitable for the necessary set pressure.

GDK-2000

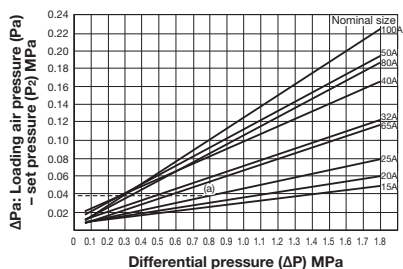

How to read the chart (GDK-2000)

When the nominal size is 25A, the inlet pressure (P₁) is 1.0 MPa, and the reduced pressure (P₂) is 0.2 MPa, the loading air pressure is calculated as follows: Trace up vertically from the differential pressure (ΔP) before and after the pressure reducing valve (1.0 MPa - 0.2 MPa = 0.8 MPa) to find intersection point (a) with the nominal size of 25A. Calculate ΔPa [loading air pressure (Pa) - set pressure (P₂)] = 0.037 MPa by horizontally tracing to the left from intersection point (a). Thus, the loading air pressure is: (Pa) = ΔPa + P₂ = 0.037 + 0.2 = 0.237 MPa.

CP-2000 Series

<combination valve>

Need to use pressure reducing valves, solenoid valves, temperature regulators or its combination for a specific purpose, with large space and great cost for installation . . . Have you ever imagined that it may be helpful if a single valve combines such functions? Yoshitake CP-2000 Series integrates such functions into a single valve to realize space reduction, cost saving and controllability of plural valves without efforts.

■CP-2001

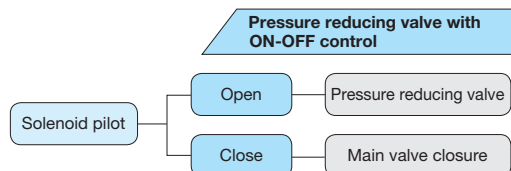

CP-2001 flanged type

Application	Steam	
Inlet pressure	0.1-1.0 MPa	
Reduced pressure	0.02-0.15 MPa 0.1-0.85 MPa	
Maximum temperature	183°C	
Actuation of solenoid valve	Normally closed	
Rated voltage	AC 100 V, 50 / 60 Hz available AC 200 V, 50 / 60 Hz available	
Connection	JIS Rc screwed JIS 10K flanged	
Material	Main valve body	Ductile cast iron
	Main valve, valve seat	Stainless steel
	Diaphragm	Stainless steel
Nominal size	Screwed: 15A-50A Flanged: 15A-100A	

· Please contact us for other specifications.

Reliable ON-OFF system by the CP-2001

■CP-2001

Steam is usually supplied only when required. This means that steam is controlled as a batch (intermittent) system. Steam ON/OFF is switched by solenoid valve, however, rapid opening/closing operation of solenoid valve causes various problems to other devices such as pressure reducing valve. To solve such problems, we recommend CP-2001.

<Control example>

Solenoid valve ON	$P_1 = 1.0 \text{ MPa}$	$P_2 = 0.2 \text{ MPa}$
Solenoid valve OFF	$P_1 = 1.0 \text{ MPa}$	$P_2 = 0 \text{ MPa}$

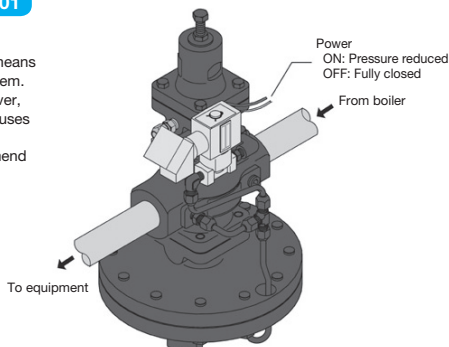

■CP-2002

Pressure reducing valve and full-open valve

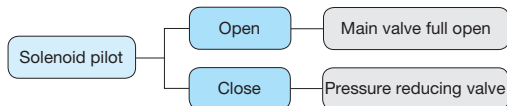

Application	Steam	
Inlet pressure	0.1-1.0 MPa	
Reduced pressure	0.02-0.15 MPa 0.1-0.85 MPa	
Maximum temperature	183°C	
Actuation of solenoid valve	Normally closed	
Rated voltage	AC 100 V, 50 / 60 Hz available AC 200 V, 50 / 60 Hz available	
Connection	JIS Rc screwed JIS 10K flanged	
Material	Main valve body	Ductile cast iron
	Main valve, valve seat	Stainless steel
	Diaphragm	Stainless steel
Nominal size	Screwed: 15A-50A Flanged: 15A-100A	

· Please contact us for other specifications.



CP-2002 Flanged type

Quicker startup feasible with the CP-2003

■CP-2003

In order to increase the performance and efficiency of the system and to save energy, a high-pressure steam line and a low-pressure steam line are used together. For this purpose two or more pressure valves have been used. Air is discharged with low-pressure steam and then rapidly raised to the intended temperature with high-pressure steam, and regular operation begins with low-pressure steam. Our CP-2003 can perform these operations alone.

<Control example>

Solenoid valve ON	$P_1 = 1.0 \text{ MPa}$	$P_2 = 0.5 \text{ MPa}$
Solenoid valve OFF	$P_1 = 1.0 \text{ MPa}$	$P_2 = 0.2 \text{ MPa}$

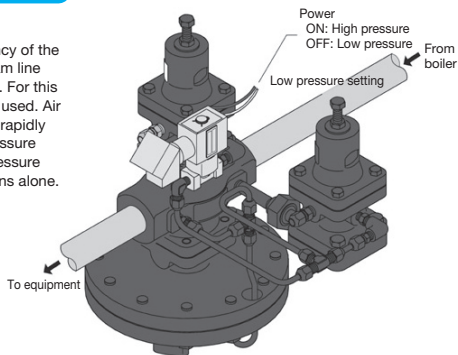

■CP-2003

Two-point switching of reduced pressure

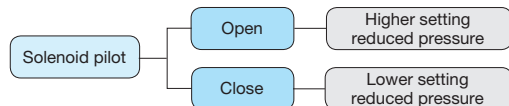

Application	Steam	
Inlet pressure	0.1-1.0 MPa	
Reduced pressure	0.02-0.15 MPa 0.1-0.85 MPa	
Maximum temperature	183°C	
Actuation of solenoid valve	Normally closed	
Rated voltage	AC 100 V, 50 / 60 Hz available AC 200 V, 50 / 60 Hz available	
Connection	JIS Rc screwed JIS 10K flanged	
Material	Main valve body	Ductile cast iron
	Main valve, valve seat	Stainless steel
	Diaphragm	Stainless steel
Nominal size	Screwed: 15A-50A Flanged: 15A-100A	

· Please contact us for other specifications.



CP-2003 Flanged type

■CP-2004

Switching of reduced pressure with ON-OFF control

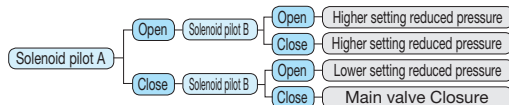

Application	Steam	
Inlet pressure	0.1-1.0 MPa	
Reduced pressure	0.02-0.15 MPa 0.1-0.85 MPa	
Maximum temperature	183°C	
Actuation of solenoid valve	Normally closed	
Rated voltage	AC 100 V, 50 / 60 Hz available AC 200 V, 50 / 60 Hz available	
Connection	JIS Rc screwed JIS 10K flanged	
Material	Main valve body	Ductile cast iron
	Main valve, valve seat	Stainless steel
	Diaphragm	Stainless steel
Nominal size	Screwed: 15A-50A Flanged: 15A-100A	

· Please contact us for other specifications.

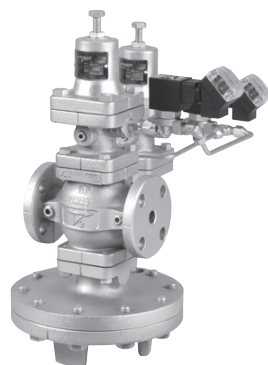

CP-2004 Flanged type

■CP-2005

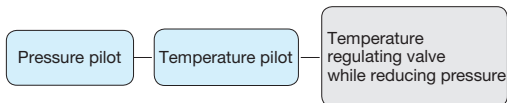
Temperature regulating valve
with pressure control

Application	Heating fluid	Steam
	Heated fluid	Water, Oil, Liquid
Inlet pressure		0.1-2.0 MPa
Reduced pressure		0.02-0.15 MPa 0.1-1.4 MPa
Maximum temperature		220°C
Bulb maximum pressure		1.0 MPa
Temperature adjustment range		-8 - 183°C
Connection		JIS Rc screwed JIS 10K/20K flanged
Material	Main valve body	Ductile cast iron
	Main valve, valve seat	Stainless steel
	Diaphragm	Stainless steel
Nominal size		Screwed: 15A-50A Flanged: 15A-100A

- Standard sensor length is 2M.
- Please contact us for other specifications.



CP-2005 Flanged type

■CP-2006

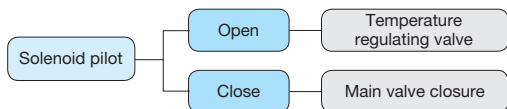
Temperature regulating valve
with ON-OFF control

Application	Heating fluid	Steam
	Heated fluid	Water, Oil, Liquid
Maximum pressure		1.0 MPa
Maximum temperature		183°C
Actuation of solenoid valve		Normally closed
Rated voltage		AC 100 V, 50 / 60 Hz available AC 200 V, 50 / 60 Hz available
Bulb maximum pressure		1.0 MPa
Temperature adjustment range		-8 - 183°C
Connection		JIS Rc screwed JIS 10K flanged
Material	Body	Ductile cast iron
	Main valve, valve seat	Stainless steel
	Diaphragm	Stainless steel
Nominal size		Screwed: 15A-50A Flanged: 15A-100A

- Standard sensor length is 2M.
- Please contact us for other specifications.



CP-2006 Flanged type

GP-2000CS

Direct type	Pilot type	Piston	Diaphragm
Bellows	Internal sensing	External sensing	Stainless steel
With handle	Built-in strainer	Low pressure	Remote
Valve leakage 0	Nylon		



■ Features

1. The GP-2000CS pressure reducing valve for steam is pilot operated diaphragm type, which can control larger flow of fluid than piston type, offering superior controllability for pressure fluctuation of inlet side or load fluctuation of outlet side.
2. 200 mesh integral screen prevents most scale problem on the pilot valve.
3. Spherical valve provides a tight seal meeting ANSI Class IV.

■ Specifications

Model		GP-2000CS			
Application		Steam			
Reduced pressure sensing method		External sensing *			
Max. inlet pressure		3.0 MPa	1.0 MPa	2.0 MPa	3.0 MPa
Reduced pressure		0.02-0.15 MPa 0.1-1.4 MPa 1.3-2.0 MPa	0.02-0.15 MPa 0.1-0.85 MPa	0.02-0.15 MPa 0.1-1.4 MPa 1.3-1.7 MPa	0.02-0.15 MPa 0.1-1.4 MPa 1.3-2.0 MPa
		85% or less of inlet pressure (gauge pressure)			
Minimum differential pressure		0.05 MPa			
Maximum pressure reduction ratio		20:1			
Maximum temperature		260°C			
Valve seat leakage		0.01% or less of rated flow rate			
Material	Body	Cast carbon steel			
	Main valve, valve seat	Stellite overlaid stainless steel			
	Pilot valve, pilot valve seat	Stainless steel			
	Diaphragm	Stainless steel			
Connection		JIS Rc screwed	JIS 10K FF flanged	JIS 20K RF flanged	JIS 30K RF flanged

* Please prepare a sensing pipe at your end.

Joint size is as follow:

JIS Rc, JIS SW, JIS 10K FF, 20K RF and 30K RF: Rc 1/4

NPT, ASME class 150 and 300: NPT 1/4

Make the length the sense of piping less than 5 m.

When installing the pressure reducing valve, be sure to connect the sensing pipe and joint. Unless the sensing pipe is connected, the valve will not operate.

· Available with SW (socket weld) for 15-50A.

· Available with ASME or EN flanged.

■ Dimensions (mm) and Weights (kg)

· JIS Rc screwed

Nominal size	d	L	H	H ₁	Weight
15A	Rc 1/2	150	398	170	16
20A	Rc 3/4	150	398	170	16
25A	Rc 1	160	404	175	21.5
32A	Rc 1-1/4	180	434	192	24
40A	Rc 1-1/2	180	434	192	24
50A	Rc 2	230	498	216	37

· JIS 30K RF flanged

Nominal size	L	H	H ₁	Weight
50A	230	498	216	42
65A	294	552	251	75
80A	314	575	264	84
100A	358	658	321	133

· Welded flanged type (JIS 30KRF)

Nominal size	L	H	H ₁	A	Weight
15A	240	398	170	200	18.0
20A	240	398	170	200	18.0
25A	250	404	175	226	24.5
32A	260	434	192	226	27.0
40A	260	434	192	226	27.0
50A	320	498	216	276	40.0

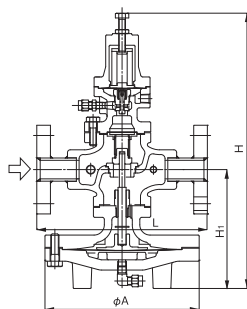
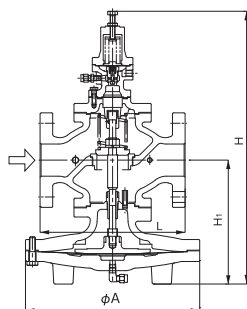
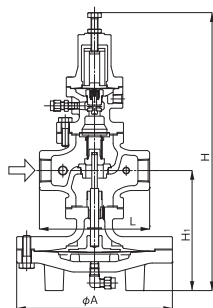

Specifications Selection Chart

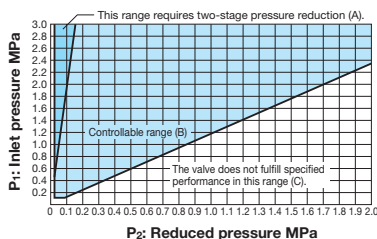

Based on the selection chart above, select a pressure reducing valve in the optimum manner. On the selection chart, first find the intersection point of the inlet pressure (P₁) and the reduced pressure (P₂). Two-stage pressure reduction is required if the intersection point lies in range (A), or the pressures are controllable with a single pressure reducing valve if the intersection point is within range (B). The valve does not fulfill specified performance in range (C). To adopt two-stage pressure reduction, separate two pressure reducing valves as far away from each other as possible. (3M)

Flow Characteristic Chart

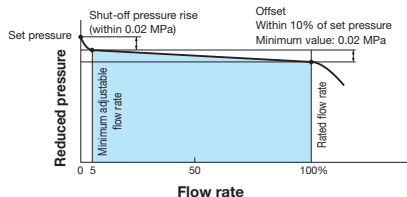

When selecting a nominal size, set the flow rate at 80 to 90% of the rated flow rate, allowing for the pressure loss and heat loss of the stop valve, strainer, etc. to be used before or after the pressure reducing valve. To enable the pressure reducing valve to show a maximum flow characteristic, do not select a small piping diameter, as a countermeasure against the effect of piping resistance. Select a nominal size based on the nominal sizes selection chart.

Pressure Characteristic Chart

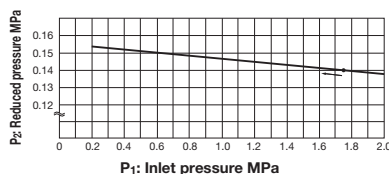

This chart shows variation in reduced pressure when the inlet pressure of 1.75 MPa is changed between 0.2 MPa to 2.0 MPa while the reduced pressure is set at 0.14 MPa.

Set pressure of safety valve for alarm use at the outlet side of the pressure reducing valve for steam

Set pressure of the pressure reducing valve (MPa)	Set pressure of safety valve (MPa)
0.1 or less	Set pressure of the pressure reducing valve + 0.05 or more
0.11-0.4	Set pressure of the pressure reducing valve + 0.08 or more
0.41-0.6	Set pressure of the pressure reducing valve + 0.1 or more
0.61-0.8	Set pressure of the pressure reducing valve + 0.12 or more
More than 0.8	Set pressure of the pressure reducing valve + 15%

* When a safety valve is installed for alarm use at the outlet side of a pressure reducing valve for steam and there are no laws or regulations specified to comply with, select a safety valve whose blowout capacity is around 10% of the maximum flow rate of the pressure reducing valve.

■GP-2000CS Nominal Sizes Selection Chart (For Steam)

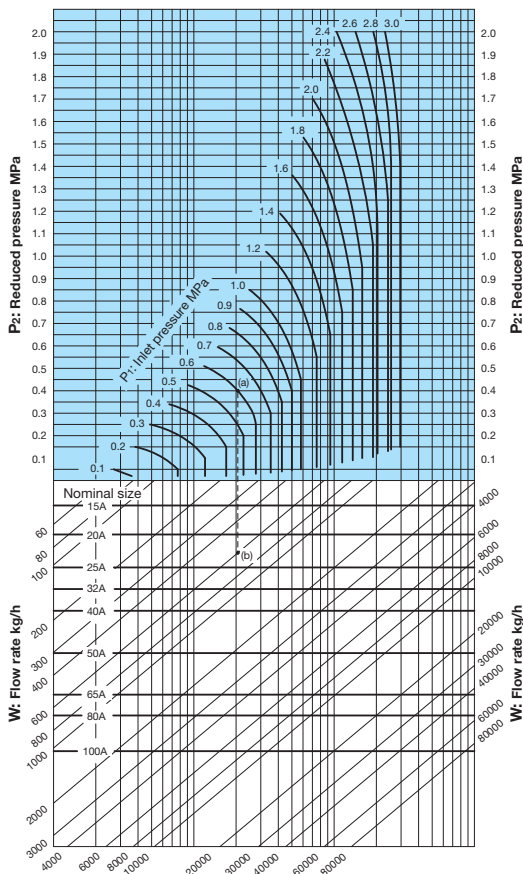

[Example]

When selecting the nominal size of a pressure reducing valve whose inlet pressure (P₁), reduced pressure (P₂), and flow rate are 0.6 MPa, 0.4 MPa, and 600 kg/h, respectively, first find intersection point (a) of the inlet pressure of 0.6 MPa and the reduced pressure of 0.4 MPa. Trace down vertically from this intersection point to find intersection point (b) with the flow rate of 600 kg/h. Since intersection point (b) lies between nominal sizes 20A and 25A, select the larger one, 25A.

- Set the safety factor at 80 to 90%.

GP-1000, 1000EN

- Direct type Pilot type Piston Diaphragm
- Bellows Internal sensing External sensing Stainless steel
- With handle Built-in strainer Low pressure Remote
- Valve leakage 0 Nylon

■ Features

1. Significantly improved workability and durability compared with conventional pressure reducing valves.
2. Spherical main valve offers great sealability and great reduction of valve seat leakage (compliant with ANSI Class IV).
3. Compliant with SHASE-S106 Pressure Reducing Valves (by the Society of Heating, Air-Conditioning and Sanitary Engineers of Japan).
4. Simple and robust internal structure.



GP-1000 - 1002



GP-1200



GP-1010



GP-1001

Description of GP-1000 Series model code

GP-1000□

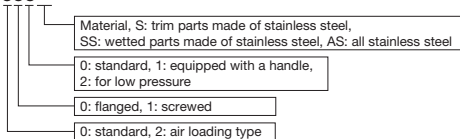

■ Specifications

For low pressure

Model	GP-1000 - 1001	GP-1002	GP-1010	GP-1200	GP-1210	GP-1000EN
Application	Steam					
Inlet pressure	0.1-1.0 MPa	0.1-0.5 MPa				0.1-1.0 MPa
Reduced pressure	0.05-0.9 MPa	0.03-0.15 MPa				0.05-0.9 MPa
	90% or less of inlet pressure (gauge pressure)					
Minimum differential pressure	0.05 MPa					
Maximum pressure reduction ratio	20:1					
Maximum temperature	220°C					
Valve seat leakage	0.01% or less of rated flow					
Material	Body		Ductile cast iron			
	Valve, valve seat		Stainless steel			
	Piston, cylinder		Brass or bronze			
Connection	JIS 10K FF flanged		JIS Rc screwed	JIS 10K FF flanged	JIS Rc screwed	EN PN16 flanged

· Available with trim parts (piston and cylinder) made of stainless steel (GP-□□□□S).

GP-1000SS,AS

Direct type	Pilot type	Piston	Diaphragm
Bellows	Internal sensing	External sensing	Stainless steel
With handle	Built-in strainer	Low pressure	Remote
Valve leakage 0	Nylon		

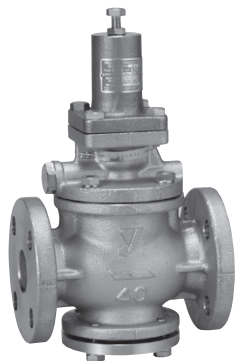

GP-1000AS

■Features

1. Improved corrosion resistance by stainless steel wetted parts (GP-1000SS) or all stainless steel made (GP-1000AS).
2. Spherical main valve offers great sealability and great reduction of valve seat leakage (compliant with ANSI Class IV).
3. Compliant with SHASE-S106 Pressure Reducing Valves (by the Society of Heating, Air-Conditioning and Sanitary Engineers of Japan).

■Specifications

Stainless steel
wetted parts

All stainless steel

Model	GP-1000SS	GP1000AS
Application	Steam	
Inlet pressure	0.1-1.0 MPa	
Reduced pressure	0.05-0.9 MPa	
	90% or less of inlet pressure (gauge pressure)	
Minimum differential pressure	0.05 MPa	
Maximum pressure reduction ratio	20:1	
Maximum temperature	220°C	
Valve seat leakage	0.01% or less of rated flow	
Material	Body	Cast stainless steel
	Valve, valve seat	Stainless steel
	Piston, cylinder	Stainless steel
Connection	JIS 10K FF flanged	

Description of GP-1000 Series model code

GP-1000□

Material, S: trim parts made of stainless steel,
SS: wetted parts made of stainless steel, AS: all stainless steel0: standard, 1: equipped with a handle,
2: for low pressure

0: flanged, 1: screwed

0: standard, 2: air loading type

■ Dimensions (mm) and Weights (kg)

• GP-1000 · 1002

Nominal size	L	H ₁	H	Weight
15A	150	64	285	8.0
20A	155	64	285	8.5
25A	160	67	300	10.0
32A	190	82	323	14.0
40A	190	82	323	14.5
50A	220	93	347	20.0
65A	245	100	357	30.0
80A	290	122	404	35.0
100A	330	144	450	52.5

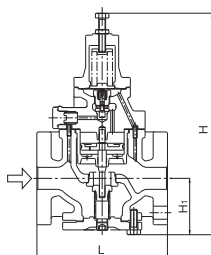

• GP-1010

Nominal size	d	L	H ₁	H	Weight
15A	Rc 1/2	150	64	285	7.0
20A	Rc 3/4	155	64	285	7.0
25A	Rc 1	160	67	300	8.5
32A	Rc 1-1/4	190	82	323	12.0
40A	Rc 1-1/2	190	82	323	12.5
50A	Rc 2	220	93	347	18.0

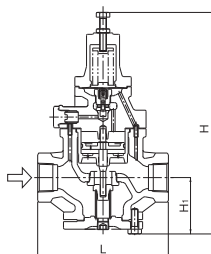

• GP-1200

Nominal size	L	H ₁	H	Weight
15A	150	64	220	8.0
20A	155	64	220	8.5
25A	160	67	235	10.0
32A	190	82	258	14.0
40A	190	82	258	14.5
50A	220	93	282	20.0
65A	245	100	292	30.0
80A	290	122	339	35.0
100A	330	144	385	52.5

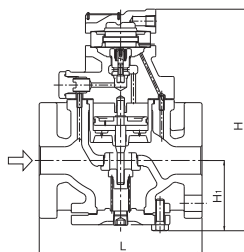

• GP-1210

Nominal size	d	L	H ₁	H	Weight
15A	Rc 1/2	150	64	220	7.0
20A	Rc 3/4	155	64	220	7.0
25A	Rc 1	160	67	235	8.5
32A	Rc 1-1/4	190	82	258	12.0
40A	Rc 1-1/2	190	82	258	12.5
50A	Rc 2	220	93	282	18.0

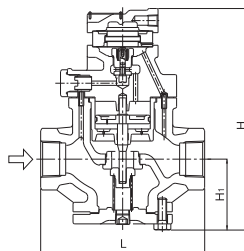

· GP-1000SS · 1000AS

Nominal size	L	H ₁	H	Weight
15A	150	67	288(298)	8.3(8.5)
20A	155	67	288(298)	8.8(9.0)
25A	160	70	303(313)	10.5(10.7)
32A	190	85	326(336)	14.8(15.0)
40A	190	85	326(336)	15.3(15.5)
50A	220	96	350(360)	20.8(21.0)
65A	245	103	360(370)	27.4(27.6)
80A	290	125	407(417)	38.8(39.0)
100A	330	148	454(464)	54.5(54.7)

* The values in parentheses are the dimensions and weights of the GP-1000AS.

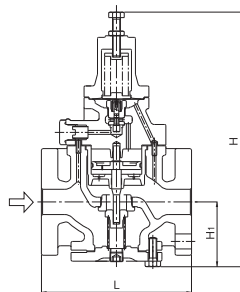

■ Nominal Sizes Selection Chart (For Steam)

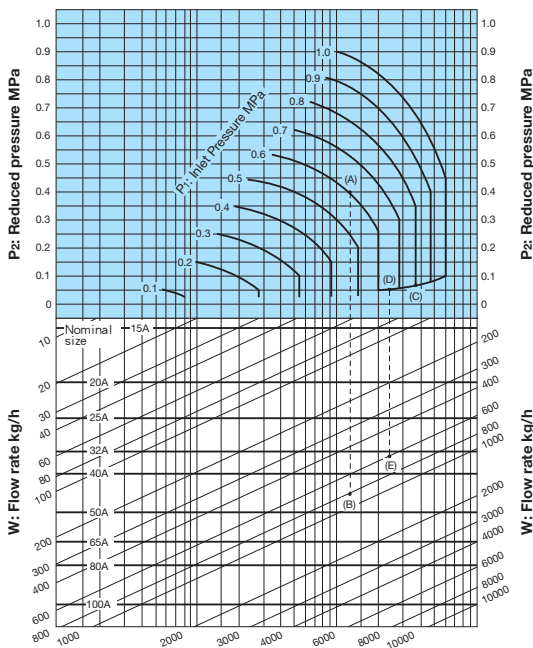

[Example 1]

When selecting the nominal size of a pressure reducing valve whose inlet pressure (P_1), reduced pressure (P_2), and steam flow rate are 0.6 MPa, 0.4 MPa, and 800 kg/h, respectively, first find intersection point (A) of the inlet pressure of 0.6 MPa and the reduced pressure of 0.4 MPa.

Trace down vertically from this intersection point to find intersection point (B) with the flow rate of 800 kg/h. Since intersection point (B) lies between nominal sizes 40A and 50A, select the larger one, 50A.

[Example 2]

When selecting the nominal size of a pressure reducing valve whose inlet pressure (P_1), reduced pressure (P_2), and steam flow rate are 0.8 MPa, 0.05 MPa, and 600 kg/h, respectively, first find intersection point (C) of the inlet pressure of 0.8 MPa and the diagonal line. Trace down to the left from this intersection point to find intersection point (D) with the reduced pressure of 0.05 MPa.

Trace down vertically from intersection point (D) to find intersection point (E) with the flow rate of 600 kg/h. Since intersection point (E) lies between nominal sizes 32A and 40A, select the larger one, 40A.

· Set the safety factor at 80 to 90%.

Specifications Selection Chart

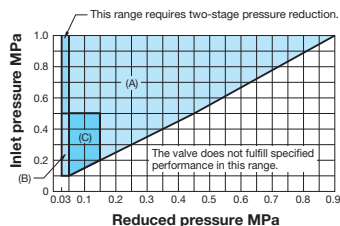

Find the intersection point of the inlet and reduced pressures. If the intersection point is within any of the ranges shown in the chart above, the pressures are controllable.

- Range (A) and (C): GP-1000 Series except GP-1002 and 1012
- Range (B) and (C): GP-1002 and 1012

Specifications Selection Chart

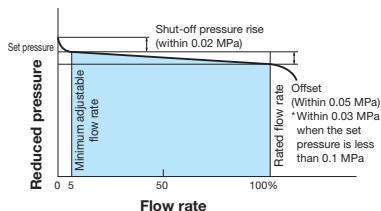

■ Loading Air Pressure-set Pressure Chart

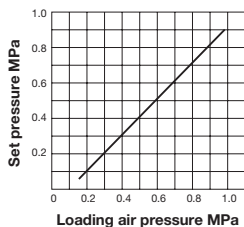

Basically, the set pressure to the loading air pressure is as shown on the left. The set pressure is slightly different depending on the conditions. For the actual use, adjust the loading air pressure suitable for necessary set pressure.

Corrected Cv value

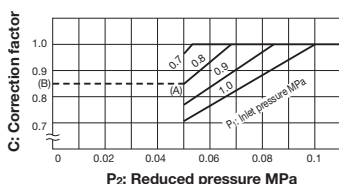

Example

Take a pressure reducing valve whose inlet pressure is 0.8 MPa, the reduced pressure is 0.05 MPa. Find the inlet and reduced pressure intersection point (A) at the above chart, then draw a horizontal line in the leftward direction to point (B) which indicates a correction coefficient of 0.85. For a nominal size of 25A, the corrected Cv value would be calculated as follows:

$$4 \text{ (rated Cv value)} \times 0.85 \text{ (correction coefficient)} = 3.4$$

Pressure Characteristic Chart

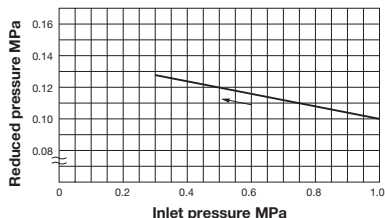

This chart shows variation in reduced pressure when the inlet pressure of 1.0 MPa is changed between 0.3 MPa and 1.0 MPa while the reduced pressure is set at 0.1 MPa.

- Set pressure of safety valve for alarm use at the outlet side of the pressure reducing valve for steam

Set pressure of pressure reducing valve (MPa)	Set pressure of safety valve (MPa)
0.1 or less	Set pressure of the pressure reducing valve + 0.05 or more
0.11-0.4	Set pressure of the pressure reducing valve + 0.08 or more
0.41-0.6	Set pressure of the pressure reducing valve + 0.1 or more
0.61-0.8	Set pressure of the pressure reducing valve + 0.12 or more
More than 0.8	Set pressure of the pressure reducing valve + 15%

- When a safety valve is installed for alarm use at the outlet side of a pressure reducing valve for steam and there are no laws or regulations specified to comply with, select a safety valve whose blowout capacity is around 10% of the maximum flow rate of the pressure reducing valve.

■GP-1000 Flow Rate Table

(kg/h)										
P ₁ (MPa)	P ₂ (MPa)	15A	20A	25A	32A	40A	50A	65A	80A	100A
1	0.05 *	92	212	369	600	831	1,478	2,310	3,326	5,913
	0.1-0.4	132	303	528	858	1,188	2,112	3,300	4,752	8,448
	0.5	127	292	508	825	1,143	2,033	3,176	4,574	8,132
	0.6	116	268	467	760	1,052	1,871	2,923	4,210	7,484
	0.7	104	239	416	676	936	1,664	2,601	3,745	6,659
	0.8	87	200	348	566	784	1,394	2,179	3,137	5,578
0.9	0.1-0.4	120	276	480	780	1,080	1,920	3,000	4,320	7,680
	0.5	110	253	441	716	992	1,764	2,756	3,969	7,056
	0.6	98	226	393	639	885	1,574	2,460	3,543	6,299
	0.7	82	190	330	537	744	1,323	2,067	2,976	5,292
	0.8	60	138	240	390	540	961	1,501	2,162	3,844
0.8	0.1-0.3	108	248	432	702	972	1,728	2,700	3,888	6,912
	0.4	103	237	412	670	928	1,650	2,578	3,712	6,600
	0.5	92	212	369	600	832	1,479	2,311	3,328	5,916
	0.6	77	179	311	506	701	1,247	1,949	2,806	4,989
	0.7	56	130	227	369	511	909	1,420	2,045	3,636
0.7	0.1-0.3	96	220	384	624	864	1,536	2,400	3,456	6,144
	0.4	86	197	344	559	774	1,377	2,151	3,098	5,508
	0.5	72	167	291	474	656	1,166	1,823	2,625	4,667
	0.6	53	122	213	346	480	854	1,334	1,921	3,416
0.6	0.1-0.2	84	193	336	546	756	1,344	2,100	3,024	5,376
	0.3	79	182	316	514	712	1,266	1,979	2,850	5,067
	0.4	67	155	270	438	607	1,080	1,687	2,430	4,321
	0.5	49	114	198	322	447	795	1,242	1,788	3,180
0.5	0.1-0.2	72	165	288	468	648	1,152	1,800	2,592	4,608
	0.3	61	141	246	400	554	986	1,540	2,218	3,944
	0.4	45	105	182	297	411	731	1,142	1,645	2,925
0.4	0.1	60	138	240	390	540	960	1,500	2,160	3,840
	0.2	55	126	220	358	496	882	1,378	1,984	3,528
	0.3	41	95	165	268	372	661	1,033	1,488	2,646
0.3	0.1	48	110	192	312	432	768	1,200	1,728	3,072
	0.2	36	83	145	237	328	583	911	1,312	2,333
0.2	0.1	30	70	123	200	277	493	770	1,109	1,972
0.1	0.05	18	41	72	118	164	291	455	656	1,166

* When the inlet pressure is more than 0.7 MPa and the pressure reduction ratio is more than 10:1, calculate the corrected Cv value multiplying the rated Cv value by the correction factor C obtained from Fig.1.

GP-1000HEN, 1000H

Direct type	Pilot type	Piston	Diaphragm
Bellows	Internal sensing	External sensing	Stainless steel
With handle	Built-in strainer	Low pressure	Remote
Valve leakage 0	Nylon		

■Features

- The GP-1000HEN can be replaced easily from existing valve because it complies with face-to-face dimensions of the EN standard.
- Respond very sharply to the fluctuation of inlet pressure and the change of the flow rate, so that the reduced pressure can be kept at a constant level.
- Pressure adjustment is easy, and the set pressure range is wide.
- Compliant with the standard of SHASE-S106 Pressure Reducing Valves (by the Society of Heating, Air-Conditioning and Sanitary Engineers of Japan).



GP-1000H

■Specifications

Model	GP-1000HEN	GP-1000H
Application	Steam	
Inlet pressure	0.1-1.6 MPa	
Reduced pressure	(A) 0.05-0.9 MPa (B) 0.9-1.4 MPa	
	90% or less of inlet pressure (gauge pressure)	
Minimum differential pressure	0.05 MPa	
Maximum pressure reduction ratio	20:1	
Maximum temperature	220°C	
Valve seat leakage	0.01% or less of rated flow rate	
Material	Body	
	Ductile cast iron	
	Main valve, valve seat	
	Stainless steel	
	Pilot valve, pilot valve seat	
Stainless steel		
Piston, cylinder		
Stainless steel		
Diaphragm		
Stainless steel		
Connection	EN PN25 flanged	JIS 16K FF flanged ASME Class 300 flanged

· Available with JIS Rc screwed (GP-1010H).

· For 15A, 20A, ASME flange is not available.

■Dimensions (mm) and Weights (kg)

Nominal size	L		H	H ₁	Weight	
	GP-1000HEN	GP-1000H			GP-1000HEN	GP-1000H
15A	150	150 (-)	291	64	8.0	8.0 (-)
20A	150	155 (-)	291	64	8.5	8.5 (-)
25A	160	160 (160)	300	67	10.0	10.0 (10.0)
32A	180	190 (180)	333	82	14.0	14.0 (14.0)
40A	200	190 (200)	333	82	15.5	14.5 (15.5)
50A	230	220 (230)	353	93	21.0	20.0 (21.0)
65A	290	245 (278)	357	100	30.0	30.0 (30.0)
80A	310	290 (310)	404	122	37.0	35.0 (37.0)
100A	350	330 (350)	450	144	57.0	52.5 (57.0)

· The values in parentheses are the dimensions of ASME Class 300 flanged.

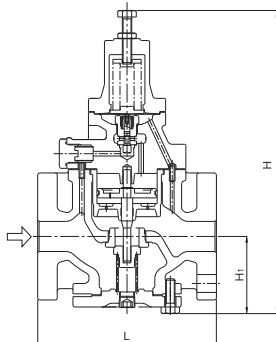

Specifications Selection Chart

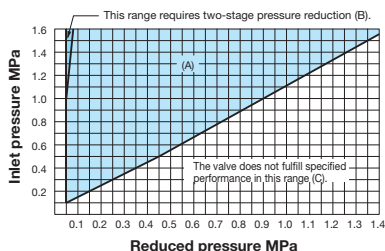

Find the intersection point of the inlet and reduced pressures. If the intersection point is within range (A) in the chart, the pressures are controllable with a single pressure reducing valve.

They can be controlled by two-stage pressure reduction if the intersection point is within range (B). The valve does not fulfill specified performance in range (C).

Flow Characteristic Chart

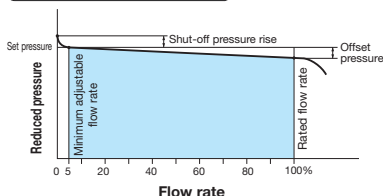

- Shut-off pressure rise: Within 0.02 MPa
- Offset pressure: Within 0.03 MPa
(when the set pressure is between 0.05 MPa and 0.1 MPa)
- Within 0.05 MPa (when the set pressure is more than 0.1 MPa and 1.4 MPa or less)

Table of Corrected Cv Values

Table of rated Cv values (Cv value when the correction factor C = 1)

Nominal size	15A	20A	25A	32A	40A	50A	65A	80A	100A
Cv values	1	2.3	4	6.5	9	16	25	36	64

Note) When the reduced pressure is within either of the ranges shown below, calculate the corrected Cv value by multiplying the rated Cv value by the correction factor C obtained from the Fig.1.

- When the inlet pressure is between 0.7 MPa and 1.0 MPa and the pressure reduction ratio is more than 10:1
- When the inlet pressure is more than 1.0 MPa and the reduced pressure is 0.4 MPa or less

Fig. 1: Corrected Cv value

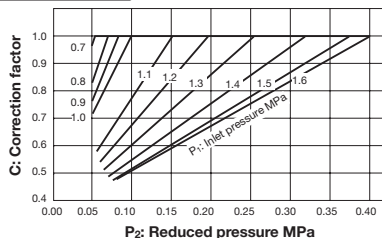

■ GP-1000HEN, 1000H Nominal Sizes Selection Chart (For Steam)

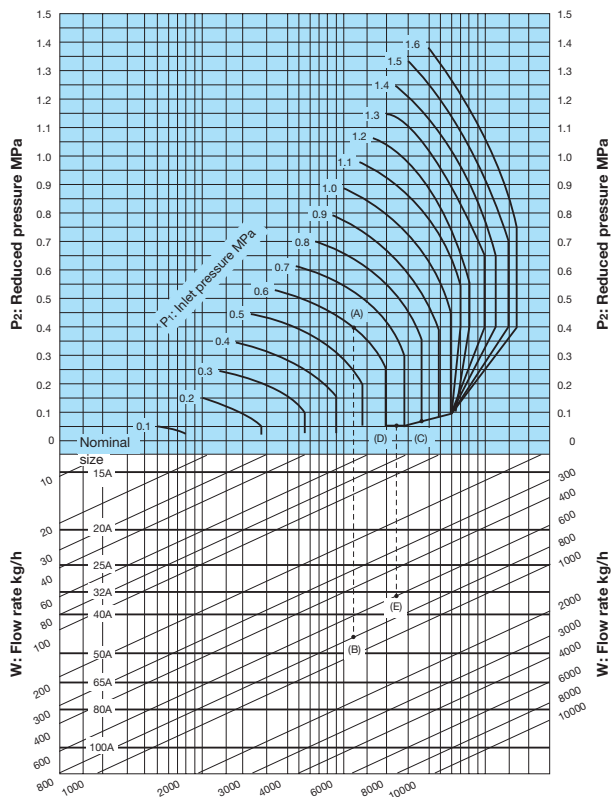
**[Example 1]**

When selecting the nominal size of a pressure reducing valve whose inlet pressure (P₁), reduced pressure (P₂), and steam flow rate are 0.6 MPa, 0.4 MPa, and 800 kg/h, respectively, first find intersection point (A) of the inlet pressure of 0.6 MPa and the reduced pressure of 0.4 MPa. Trace down vertically from this intersection point to find intersection point (B) with the flow rate of 800 kg/h. Since intersection point (B) lies between nominal sizes 40A and 50A, select the larger one, 50A.

[Example 2]

When selecting the nominal size of a pressure reducing valve whose inlet pressure (P₁), reduced pressure (P₂), and steam flow rate are 0.8 MPa, 0.05 MPa, and 600 kg/h, respectively, first find intersection point (C) of the inlet pressure of 0.8 MPa and the diagonal line. Trace down to the left from this diagonal line to find intersection point (D) with the reduced pressure of 0.05 MPa. Trace down vertically from intersection point (D) to find intersection point (E) with the flow rate of 600 kg/h. Since intersection point (E) lies between nominal sizes 32A and 40A, select the larger one, 40A.

· Set the safety factor at 80 to 90%.

GP-27

Direct type	Pilot type	Piston	Diaphragm
Bellows	Internal sensing	External sensing	Stainless steel
With handle	Built-in strainer	Low pressure	Remote
Valve leakage 0	Nylon		

■Features

1. Large capacity and distinguished performance. Can respond immediately to the fluctuation of inlet pressure and the change of flow rate to keep reduced pressure at a constant level.
2. Quite simple structure, less prone to fail and easy to handle.
3. Easy pressure adjustment and wide set pressure range.
4. No need for auxiliary power (air or electricity). Compactness makes plumbing work easy.
5. Compliant with SHASE-S106 Pressure Reducing Valves (by the Society of Heating, Air-Conditioning and Sanitary Engineers of Japan).



■Specifications

Model		GP-27
Application		Steam
Inlet pressure		0.1-1.0 MPa
Reduced pressure		0.03-0.8 MPa
		80% or less of inlet pressure (absolute pressure)
Minimum differential pressure		0.07 MPa
Maximum pressure reduction ratio		10:1
Maximum temperature		220°C
Valve seat leakage		0.05% or less of rated flow rate
Material	Body	Ductile cast iron
	Main valve, valve seat	Stainless steel
	Pilot valve, pilot valve seat	Stainless steel
	Piston, cylinder	Bronze
	Diaphragm	Stainless steel
Connection		JIS 10K FF flanged

■Dimensions (mm) and Weights (kg)

Nominal size	L	H	H ₁	Weight
125A	375	627	162	90.0
150A	420	686	190	135.0
200A	490	765	220	204.0

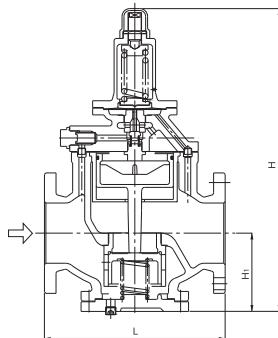

Specifications Selection Chart

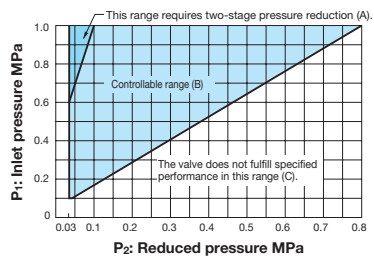

Based on the selection chart shown above, select a pressure reducing valve in the optimum manner. On the selection chart, find the intersection point of the inlet pressure (P_1) and the reduced pressure (P_2). Two-stage pressure reduction is required if the intersection point lies in range (A), or the pressures are controllable with a single pressure reducing valve if the intersection point is within range (B). The valve does not fulfill specified performance in range (C). To adopt two-stage pressure reduction, separate two pressure reducing valves as far away from each other as possible (preferably at least 3 meters).

Pressure Characteristic Chart

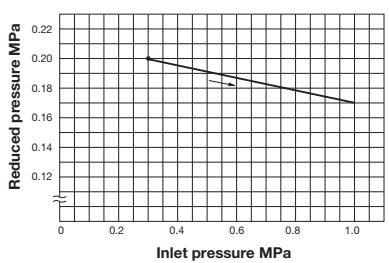

This chart shows variation in reduced pressure when the inlet pressure of 0.3 MPa is changed between 0.3 MPa and 1.0 MPa while the reduced pressure is set at 0.2 MPa.

Flow Characteristic Chart

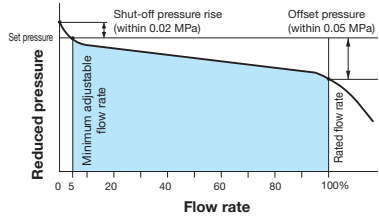

GP-27 Nominal Sizes selection Chart (For Steam)

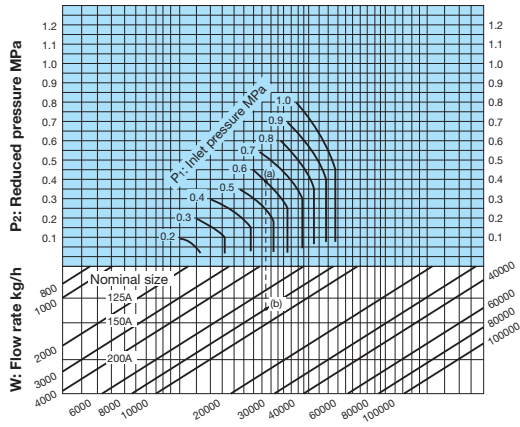

P_2 : Reduced pressure MPa
 P_1 : Inlet pressure MPa
 W : Flow rate kg/h

[Example]

When selecting the nominal size of a pressure reducing valve whose inlet pressure (P_1), reduced pressure (P_2), and steam flow rate are 0.6 MPa, 0.4 MPa, and 8000 kg/h, respectively, first find intersection point (a) of the inlet pressure of 0.6 MPa and the reduced pressure of 0.4 MPa. Trace down vertically from this intersection point to find intersection point (b) with the flow rate of 8000 kg/h. Since intersection point (b) lies between nominal sizes 125A and 150A, select the larger one, 150A.

* Set the safety factor at 80 to 90%.

GD-30,30S

Direct type	Pilot type	Piston	Diaphragm
Bellows	Internal sensing	External sensing	Stainless steel
With handle	Built-in strainer	Low pressure	Remote
Valve leakage 0	Nylon		

■Features

1. Sophisticated design, compact and lightweight.
2. Simple structure, great durability and easy maintenance.
3. Easy to install due to screwed connections.
4. Pressure adjustment is handle-operated without any tool.
5. Highly wear-resistance and durability of stainless steel made valve and valve seat.
6. A screen (60 mesh) is incorporated to protect the valve and valve seat from dirt.
7. Excellent workability accomplished by the external pressure type bellows of pressure sensing part.



GD-30



GD-30S

■Specifications

Model	GD-30	GD-30S	
Nominal size	15A-25A 40A-50A	15A-25A	
Application	Steam		
Inlet pressure	1.7 MPa or less	2.0 MPa or less	
Reduced pressure	(A) 0.02-0.1 MPa (spring color: yellow)		
	(B) 0.05-0.4 MPa (spring color: blue)		
	(C) 0.35-1.0 MPa (spring color: yellow-green)		
Minimum differential pressure	0.05 MPa		
Maximum pressure reduction ratio	10:1		
Maximum temperature	210°C	220°C	
Valve seat leakage	0.1% or less of rated flow rate		
Material	Body	Cast bronze	
	Valve, valve seat	Stainless steel	
	Bellows	Phosphor bronze	Stainless steel
Connection	JIS Rc screwed		

■ Dimensions (mm) and Weights (kg)

Nominal size	d	L	H	H ₁	Weight
15A	Rc 1/2	80	191 (196)	47 (50.5)	1.9
20A	Rc 3/4	85	191 (196)	47 (50.5)	1.9
25A	Rc 1	95	191 (196)	47 (50.5)	2.0
40A	Rc 1-1/2	140	307	77	10.1
50A	Rc 2	150	307	77	10.4

* The values in parentheses are the dimensions of the GD-30S.

■ Nominal Sizes Selection Chart (For Steam)

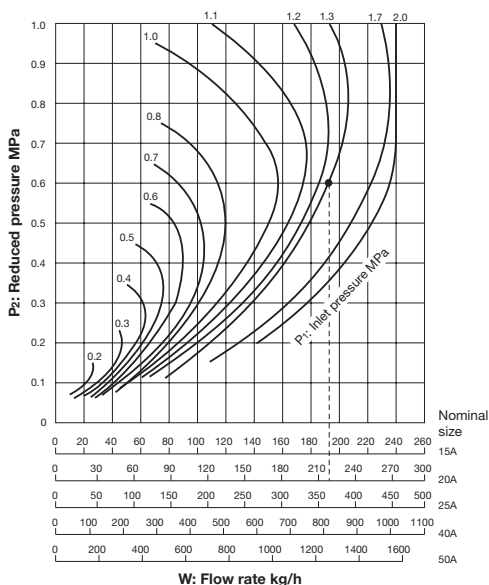

[Example]

When selecting the nominal size of a pressure reducing valve whose inlet pressure (P_1), reduced pressure (P_2), and flow rate are 1.3 MPa, 0.6 MPa, and 200 kg/h, respectively, first find the intersection point of the inlet pressure of 1.3 MPa and the reduced pressure of 0.6 MPa. Trace down vertically from this intersection point to find the nominal size with a flow rate of 200 kg/h or over. In this case, the nominal size is 20A.

Note) The nominal sizes selection chart is based on measured data. As you can see, there is no specific relationship between the pressure difference and the flow rate in the chart above, and it is, therefore, impossible to calculate a fixed Cv value.

* Set the safety factor at 80 to 90%.

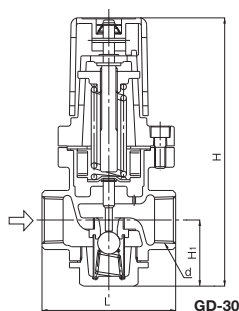

GD-30

40A-50A has different structure.

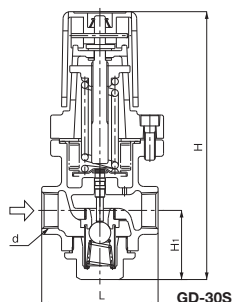

GD-30S

GD-45,45P

Direct type	Pilot type	Piston	Diaphragm
Bellows	Internal sensing	External sensing	Stainless steel
With handle	Built-in strainer	Low pressure	Remote
Valve leakage 0	Nylon		

■Features

1. Compact and lightweight.
2. Simple structure and easy maintenance.
3. Applicable to inlet pressure of up to 2.0 MPa.
4. A screen (60 mesh) is incorporated to protect the valve and valve seat from dirt.
5. Excellent workability accomplished by the external pressure type bellows of pressure sensing part.
6. Pressure adjustment is handle-operated without any tool (GD-45P).

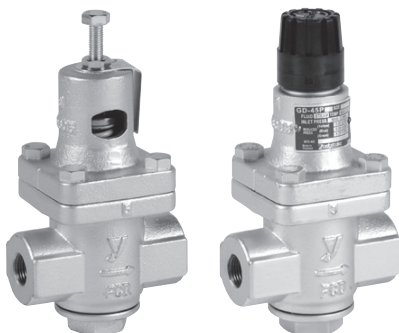

GD-45

GD-45P

■Specifications

Model	GD-45-45P
Application	Steam
Inlet pressure	2.0 MPa or less
Reduced pressure	(A) 0.02-0.1 MPa (spring color: yellow)
	(B) 0.05-0.4 MPa (spring color: blue)
	(C) 0.35-1.0 MPa (spring color: yellow green)
Minimum differential pressure	0.05 MPa
Maximum pressure reduction ratio	10:1
Maximum temperature	220°C
Valve seat leakage	0.1% or less of rated flow rate
Material	Body: Ductile cast iron
	Valve, valve seat: Stainless steel
	Bellows: Phosphor bronze
Connection	JIS Rc screwed

· The material of handle for GD-45P is using Polyphenylene sulfide (PPS resin).

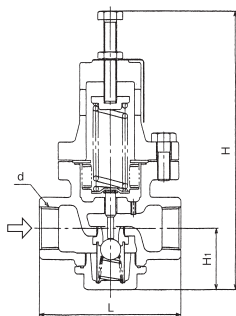

GD-45

■Dimensions (mm) and Weights (kg)

· GD-45

Nominal size	d	L	H ₁	H	Weight
15A	Rc 1/2	111	47	216	3.2
20A	Rc 3/4	111	47	216	3.2
25A	Rc 1	111	47	216	3.2

· GD-45P

Nominal size	d	L	H ₁	H	Weight
15A	Rc 1/2	111	47	213	3.2
20A	Rc 3/4	111	47	213	3.2
25A	Rc 1	111	47	213	3.2

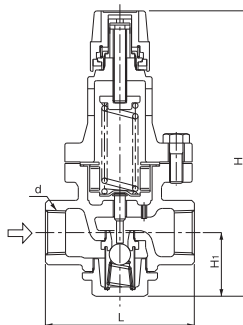

GD-45P

■ Chart for Selecting Nominal Sizes

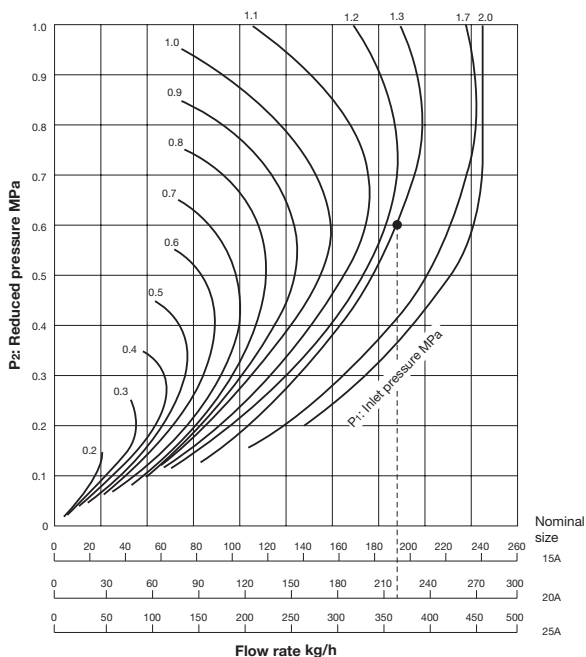

[Example]

When selecting the nominal size of a pressure reducing valve whose inlet pressure (P_1), reduced pressure (P_2), and flow rate are 1.3 MPa, 0.6 MPa, and 200 kg/h, respectively, first find the intersection point of the inlet pressure of 1.3 MPa and the reduced pressure of 0.6 MPa. Trace down vertically from this intersection point to find the nominal size with a flow rate of 200 kg/h or over. In this case, the nominal size is 20A.

* Set the safety factor at 80 to 90%.

GD-6N

Direct type	Pilot type	Piston	Diaphragm
Bellows	Internal sensing	External sensing	Stainless steel
With handle	Built-in strainer	Low pressure	Remote
Valve leakage 0	Nylon		

■Features

1. High accurate controllability of reduced pressure even at small flow rate.
2. Simple in structure, less prone to fail and easy to maintain.
3. Compact and lightweight.
4. Easy to install due to screwed connections.
5. Highly wear-resistance and durability of stainless steel made valve and valve seat. A screen (60 mesh) is incorporated to protect the valve and valve seat from dirt such as pipe scale and pipe chips.



■Specifications

Model	GD-6N	
Application	Steam	
Inlet pressure	1.0 MPa or less	
Reduced pressure	(A) 0.02-0.1 MPa (spring color: yellow) (B) 0.1-0.4 MPa (spring color: blue)	
Minimum differential pressure	0.05 MPa	
Maximum pressure reduction ratio	10:1	
Maximum temperature	220°C	
Valve seat leakage	0.1% or less of rated flow rate	
Material	Body	Ductile cast iron
	Valve, valve seat	Stainless steel
	Diaphragm	Stainless steel
Connection	JIS Rc screwed	

· Available with stainless steel wetted parts and all stainless steel made.

■Dimensions (mm) and Weights (kg)

Nominal size	d	L	H	H ₁	E	Weight
10A	Rc 3/8	165	243	57	155	5.5
15A	Rc 1/2	165	243	57	155	5.5
20A	Rc 3/4	185	267	76	175	8.2
25A	Rc 1	185	267	76	175	8.2

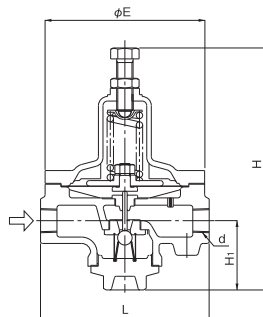

Flow Characteristic Chart

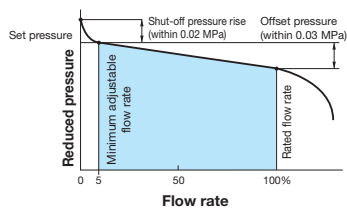

Pressure Characteristic Chart

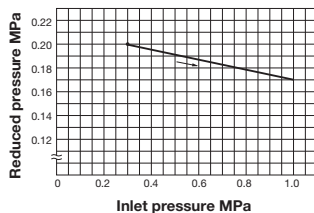

This chart shows variation in reduced pressure when the inlet pressure of 0.3 MPa is changed between 0.3 MPa and 1.0 MPa while the reduced pressure is set at 0.2 MPa.

GD-6N Nominal Sizes Selection Chart(For Steam)

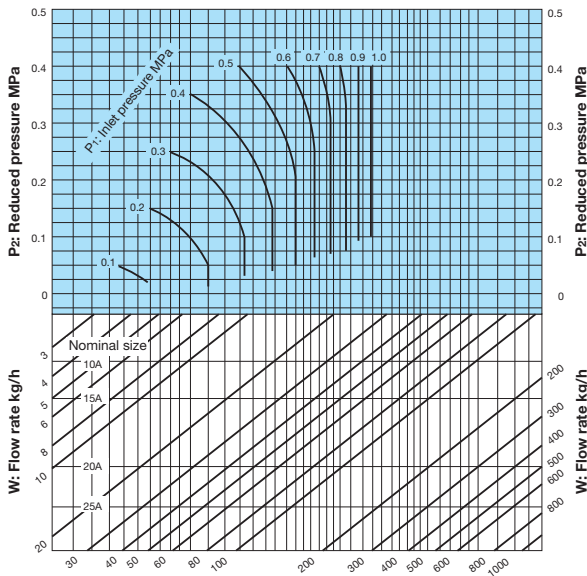

* Set the safety factor at 80 to 90%.

PRV Station

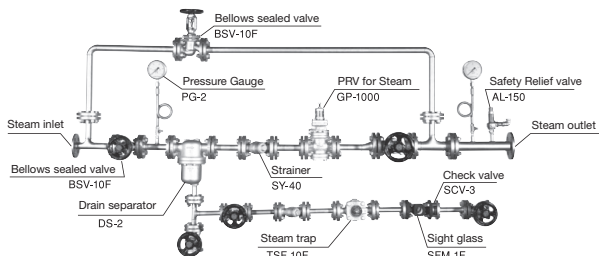

■Features

Longer service life

PRV failure caused by scale or condensate makes trouble for the entire system such as stopping the production line or malfunction of air conditioning system. Yoshitake has designed a new unit that is not affected by scale or condensate troubles under the concept of "Trouble free for PRV!".

■Specifications

Model		PRVS-1 *1	PRVS-2 *2
Nominal Size		15-100A	
Application		Steam	
Inlet pressure		0.1-1.0MPa	
Outlet pressure		0.05-0.9MPa (90% or less of inlet pressure)	
Minimum differential pressure		0.05MPa	
Max. pressure reduction ratio		20:1	
Max. temperature		220°C	
Connection	Steam inlet	JIS10KFF (15-100a)	
	Steam outlet	JIS10KFF (20-125A) *1	JIS10KFF (25-150A) *2
	Condensate outlet	Size 15-25A: JIS10K (20A) Size 32-65A: JIS10K (25A)	Size 80-100A: JIS10K (32A)
Piping material		STPG370 (Sch40)	

*1 Outlet connection is 1 size up of inlet side.

*2 Outlet connection is 2 size up of inlet connection.

● PRV station consists of PRV line and trap line. Available to provide only PRV line or trap line itself upon request.

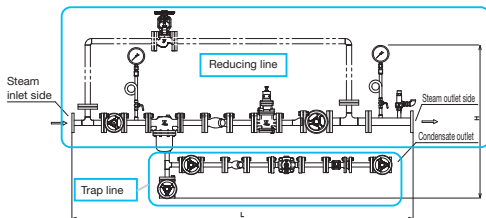

■Dimension

Size	PRVS-1		PRVS-2	
	L	H	L	H
15A	1900	865	1935	871
20A	2065	883	2130	887
25A	2185	889	2200	893
32A	2385	951	2435	956
40A	2495	955	2555	965
50A	2555	1012	2605	1019
65A	2750	1071	2965	1081
80A	3165	1170	3375	1301
100A	3645	1399	3725	1395

* All dimensions in the table are reference value.

Steam Pressure Reducing Unit PRV Station Specification Sheet

To order, please fill in this specification sheet and contact Yoshitake sales network.

Date:

Company name	Name of the contact person		
Address	〒 _____		

	TEL	FAX	
	E-mail _____		

Model			
Working condition	Inlet pressure		MPa
	Outlet pressure		MPa
	Steam amount	Minimum	kd/h
		Usual	kd/h
		Maximum	kd/h
	Connection	Steam inlet side *1	A
		Steam outlet side *2	A
	Flow direction		<input type="checkbox"/> left to right <input type="checkbox"/> right to left
Quantity		pcs	
Other request			

*1. Steam inlet connection is available with the sizes 15A to 100A.

*2. Steam inlet connection is available with the sizes 20A to 150A. Steam outlet connection is 1 or 2 size up of inlet side.

GD-26-NE Series

Direct type	Pilot type	Piston	Diaphragm
Bellows	Internal sensing	External sensing	Stainless steel
With handle	Built-in strainer	Low pressure	Remote
Valve leakage 0	Nylon		



JWWA approval
 (GD-26-NE, GD-26L-NE,
 GD-27-NE, GD-27F-N,
 GD-28-NE, GD-29-NE)



GD-26-NE · 28-NE



GD-27-NE · 29-NE

■Features

1. Wetted parts are made of corrosion-resistant material to prevent rusty water.
2. Reduced noise.
3. Pressure balance structure can keep the reduced pressure at a constant level without being affected by inlet pressure.
4. Closed structure keeps fluid inside even if the diaphragm is damaged or broken.
5. Maintenance and inspection can be conducted easily by disassembling the upper side only.
6. Compact and lightweight design makes piping works easy.

■Specifications

Model	GD-26-NE	GD-27-NE	GD-27-N	GD-27F-N	GD-28-NE	GD-29-NE
Nominal size	15A-50A	25A-100A	125A-150A		15A-50A	25A-100A
Application	Cold and hot water					
Inlet pressure	1.0 MPa or less				1.6 MPa or less	
Reduced pressure	(A)0.05-0.35 MPa (B)0.3-0.7 MPa		(A)0.05-0.2 MPa (B)0.2-0.5 MPa		(A)0.05-0.35 MPa (B)0.3-0.7 MPa	
Minimum differential pressure	0.05 MPa					
Maximum pressure reduction ratio	10:1					
Maximum temperature	90°C		80°C		90°C	
Material	Body					
	Cast bronze (NPb-treated)					
	Valve seat					
	Cast bronze (NPb-treated)					
	FKM		NBR		FKM	
	EPDM		NBR		FKM	
	EPDM		FKM		EPDM	
Connection	JIS Rc screwed	JIS 10K FF flanged	JIS 10K FF flanged		JIS Rc screwed	JIS 16K FF flanged

- A strainer (40 mesh) is incorporated in 15A to 50A. 65A to 150A do not include strainer.
- Pressure gauge connection port is JIS Rc 1/8 (for 40 φ, 0.5MPa, 1.0MPa).
- Available with pipe end core. (GD-26L-NE, maximum temperature: 20°C)
- Avoid use of 125A and 150A under differential pressure of more than 0.8 MPa.
- Available with stainless steel wetted parts (GD-26-NED, GD-27-NED).



■ Dimensions (mm) and Weights (kg)

• GD-26-NE and GD-28-NE

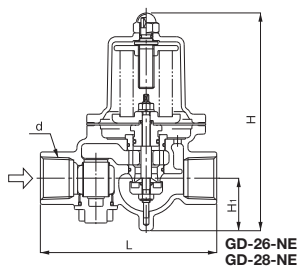

Nominal size	d	L	H	H ₁	Weight
15A	Rc 1/2	115	159.5	37.5	1.6
20A	Rc 3/4	120	159.5	38.5	1.7
25A	Rc 1	135	170	41	2.1
32A	Rc 1-1/4	180	224	57	4.0
40A	Rc 1-1/2	180	224	57	4.4
50A	Rc 2	200	239.5	61	6.5

• GD-27-NE and GD-29-NE

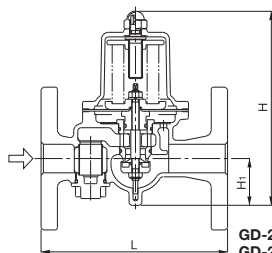

GD-27-NE
GD-29-NE
25A-50A

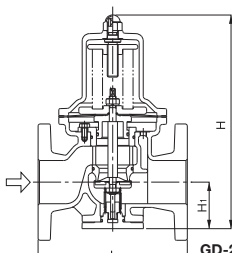

GD-27-NE
GD-29-NE
65A-100A

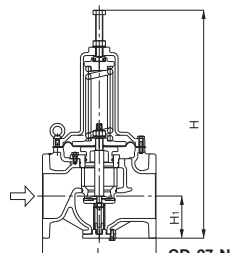

GD-27-N
125A-150A

Nominal size	L	H	H ₁	Weight
25A	160	170	41	5.1
32A	200	224	57	7.5
40A	200	224	57	7.7
50A	220	239.5	61	10.9
65A	220	329	77	20.0
80A	230(234)	345	82	22.0(24.0)
100A	270(278)	412	94	33.0(36.5)
125A	360	771	148	90.0
150A	380	771	148	97.0

* The above values in parentheses are the dimension and weights of the GD-29-NE.

* The above values of 125A and 150A are only for the GD-27-N.

GD-26S Series

Direct type	Pilot type	Piston	Diaphragm
Bellows	Internal sensing	External sensing	Stainless steel
With handle	Built-in strainer	Low pressure	Remote
Valve leakage 0	Nylon		



JWWA approval
(GD-26S-NE, GD-27S-NE)



GD-26S · 26S-NE · 28S



GD-27S · 27S-NE · 29S

■ Features

1. Wetted parts are made of corrosion-resistant material to prevent rusty water.
2. Reduced noise.
3. Pressure balance structure can keep the reduced pressure at a constant level without being affected by inlet pressure.
4. Closed structure keeps fluid inside even if the diaphragm is damaged or broken.
5. Maintenance and inspection can be conducted easily by disassembling simply from the upper side.
6. Compact and lightweight design makes piping works easy.

■ Specifications

Model	GD-26S	GD-26S-NE	GD-27S	GD-27S-NE	GD-28S	GD-29S
Application	Cold and hot water					
Inlet pressure	1.0 MPa or less				1.6 MPa or less	
Reduced pressure			(A) 0.05-0.35 MPa (B) 0.3-0.7 MPa			
Minimum differential pressure	0.05 MPa					
Maximum pressure reduction ratio	10:1					
Application temperature	5-90°C					
Material	Body					
	Cast stainless steel					
	Valve seat					
	Cast stainless steel					
	Valve disc		EPDM		FKM	
	EPDM		FKM		EPDM	
	Diaphragm		EPDM			
Connection	JIS Rc screwed		JIS 10K FF flanged		JIS Rc screwed	JIS 16K FF flanged

- A strainer (40 mesh) is incorporated in 15A to 50A. 65A to 150A do not include strainer.
- Pressure gauge connection port is JIS Rc 1/4.
(Select from ϕ 42- Max 1.0MPa, 0.4MPa, 0.2MPa).
- Available with FKM. (Except GD-26S-NE and GD-27S-NE)



■ Dimensions (mm) and Weights (kg)

· GD-26S, GD-26S-NE, and GD-28S

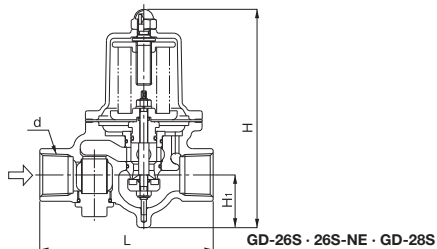

GD-26S · 26S-NE · GD-28S

Nominal size	d	L	H	H ₁	Weight
20A	Rc 3/4	135	170	41	2.2
25A	Rc 1	135	170	41	2.2
32A	Rc 1-1/4	180	224	57	4.7
40A	Rc 1-1/2	180	224	57	4.5
50A	Rc 2	200	239.5	61	6.5

· GD-27S, GD-27S-NE, and GD-29S

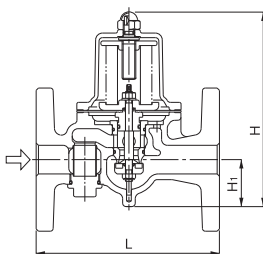

GD-27S · 27S-NE · GD-29S
25A-50A

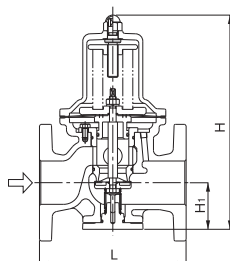

GD-27S · 27S-NE · GD-29S
65A-100A

Nominal size	L	H	H ₁	Weight
20A	160	170	41	3.9
25A	160	170	41	4.8
32A	200	224	57	8.0
40A	200	224	57	8.3
50A	220	239.5	61	10.8
65A	220	329	77	20.6
80A	230(234)	345	82	22.0(25.0)
100A	270(278)	412	94	34.5(36.5)

* The values in parentheses are the dimensions and weights of the GD-29S.

Rated flow rate

(1) <The differential pressure before and after the valve is 0.15 MPa or more.>

Nominal size	15A	20A	25A	32A	40A	50A	65A	80A	100A	125A	150A
Rated flow rate L/min	30	40	60	100	150	250	300	450	700	1,600	1,800

(2) If the differential pressure before and after the valve is less than 0.15 MPa, select a proper nominal size from the appropriate chart shown below.

Flow Rate Chart

• Nominal size: 15A to 50A

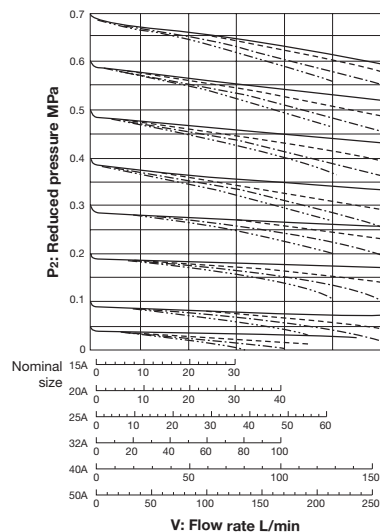

• Nominal size: 65A to 100A

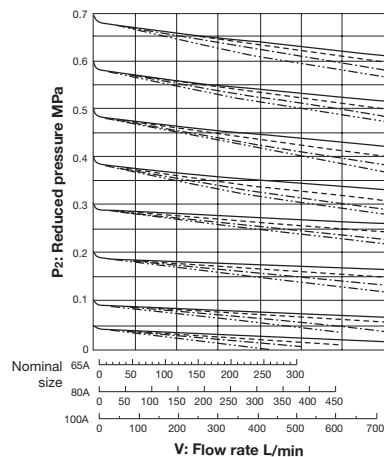

• Nominal size: 125A to 150A

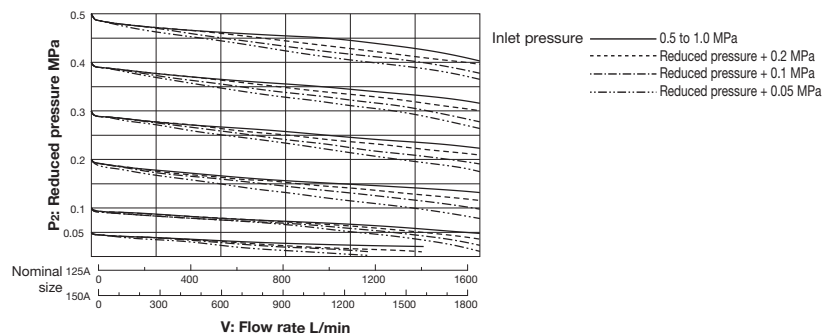

Noise Characteristic Chart

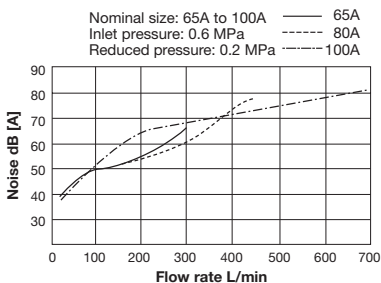
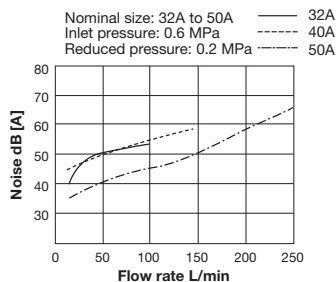
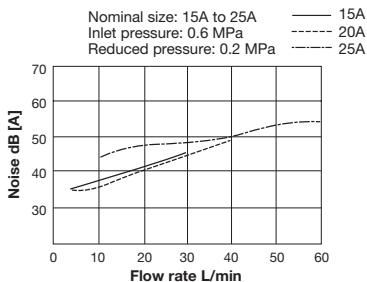

Pressure Characteristic Chart

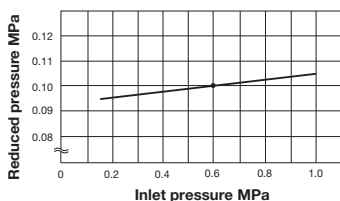

This chart shows variation in reduced pressure when the inlet pressure of 0.6 MPa is changed between 0.15 MPa and 1.0 MPa while the reduced pressure is set at 0.1 MPa.

Flow Characteristic Chart

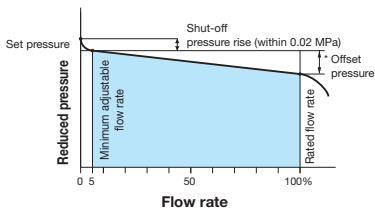

* Offset pressure

Nominal size	Pressure range	Reduced pressure range	Offset pressure
15-100A	A	0.05-0.35 MPa	Within 0.05 MPa
	B	0.30-0.70 MPa	Within 0.10 MPa
125,150A	A	0.05-0.20 MPa	Within 0.07 MPa
	B	0.20-0.50 MPa	Within 0.12 MPa

GD-27BP

Direct type	Pilot type	Piston	Diaphragm
Bellows	Internal sensing	External sensing	Stainless steel
With handle	Built-in strainer	Low pressure	Remote
Valve leakage 0	Nylon	By-pass	

JWWA approval

■Features

1. Combination of pressure reducing function, by-pass function and stop function that provide saving cost and space.
2. Enable for a wide range of pressure control in a water supply system.
3. Wetted parts are made of corrosion-resistant material to prevent rusty water.
4. Pressure balance structure can keep the reduced pressure at a constant level without being effected by inlet pressure.
5. Maintenance and inspection can be conducted easily by disassembling the upper side only.

■Specifications

Model	GD-27BP	
Nominal size	20-100A	
Application	Cold and hot water	
Inlet pressure	1.0 MPa or less	
Reduced pressure	(A) 0.05-0.35 MPa (B) 0.3-0.7 MPa	
Minimum differential pressure	0.05 MPa	
Maximum pressure reduction ratio	10:1	
Max. temperature	90°C	
Material	Body	Cast bronze (NPb-treated)
	Valve seat	Cast bronze (NPb-treated)
	Valve disc	FKM
	Diaphragm	EPDM
Connection	JIS 10K FF flanged	
Installation posture	Horizontal or vertical installation is available (For 100A, horizontal piping with upward posture only. See *1 below.)	

- Pressure gauge connection port is JIS Rc 1/4.
- Available with pressure gauge.
- Pressure reducing function is set when shipped from our factory.

* 1 Installation posture of 100A

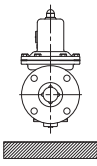
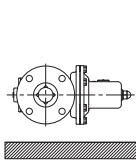
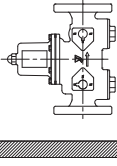
OK	NG	
Horizontal piping with upward posture	Horizontal piping with sideways posture	Vertical piping
		

■Dimensions (mm) and Weights (kg)

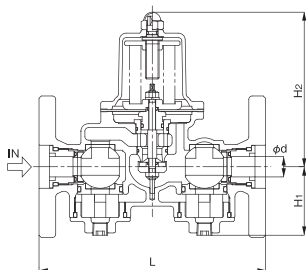

Nominal size	L	H ₁	H ₂	d	Weight
20A	200	61	137	18	6
25A	200	61	137	18	7
32A	245	72	177	28	11
40A	245	72	177	28	12
50A	260	92	186	36	16
65A	328	99	257	45	30
80A	402	112	274	56	38
100A	470	134	328	72	58

■Function

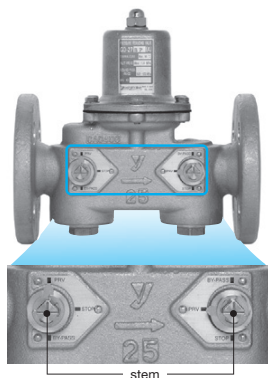

Switching of three functions (pressure reducing function, by-pass function and stop function) is conducted by operating stems at inlet side and outlet side and pointing the arrow at a certain point of the plate. Please refer to the right figure for the arrow position and fluid flow in each function. (The picture is condition of pressure reduction function)

Pressure reduction function

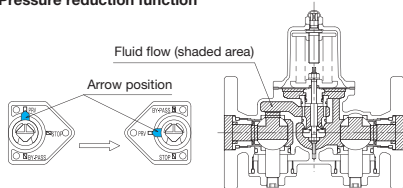

By-pass function

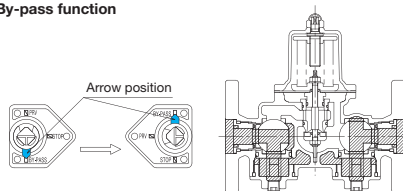

Stop function

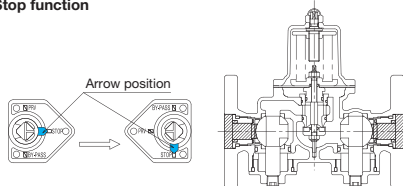

Nominal Size Selection

Rated Flow Rate

(1) <The differential pressure before and after the valve is 0.15 MPa or more.>

Nominal size	20A	25A	32A	40A	50A	65A	80A	100A
Rated flow rate L/min	40	60	100	150	250	300	450	700

(2) - If the differential pressure before and after the valve is less than 0.15 MPa, select a proper nominal size from the appropriate chart shown below.

Flow Rate Chart

• Nominal size: 20A to 50A

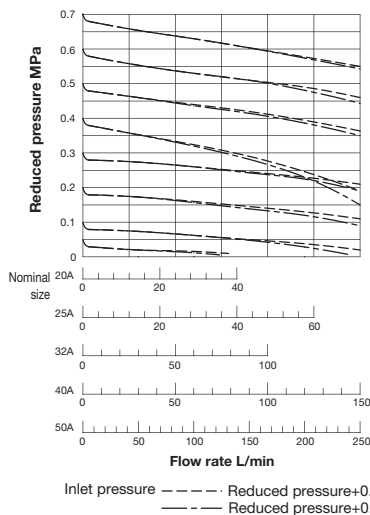

• Nominal size: 65A to 100A

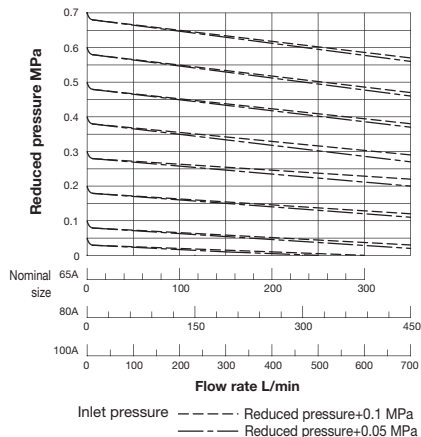

Flow Characteristic Chart

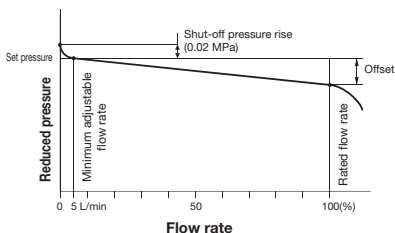

* Offset pressure

	Pressure range	Offset
A	0.05-0.35 MPa	0.10 MPa or below
B	0.30-0.70 MPa	0.15 MPa or below

Noise Characteristic Chart

· Nominal size 20-25A

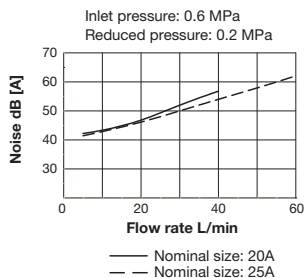

· Nominal size 32-50A

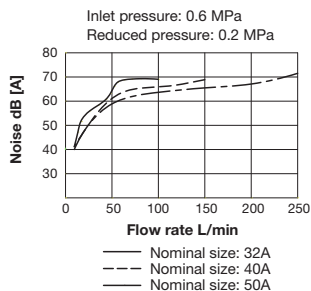

· Nominal size 65-100A

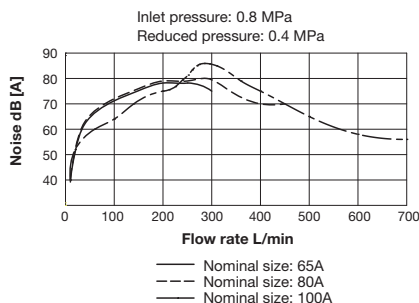

Pressure Characteristic Chart

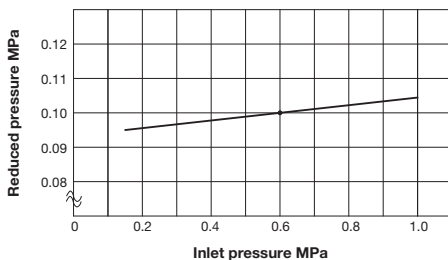

This chart shows variation in reduced pressure when the inlet pressure of 0.6 MPa is changed between 0.15 MPa and 1.0 MPa after the reduced pressure is set at 0.1 MPa.

GD-24

Direct type	Pilot type	Piston	Diaphragm
Bellows	Internal sensing	External sensing	Stainless steel
With handle	Built-in strainer	Low pressure	Remote
Valve leakage 0	Nylon		



GD-24

■Features

1. Direct acting and hanging type, no sliding parts. Free of performance deterioration caused by wear of sliding parts and great durability.
2. Wetted parts are made of corrosion-resistant material to prevent rusty water.
3. Highly wear-resistance and durability of stainless steel made valve seat.
4. Closed structure keeps fluid inside even if the diaphragm is damaged or broken.
5. Horizontal or vertical piping is possible.

· If a large capacity is required, valves can be installed in parallel.

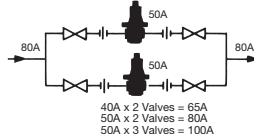

■Specifications

Model	GD-24	
Application	Cold and hot water, Flushing water	
Inlet pressure	0.2-1.6 MPa	
Reduced pressure	0.05-0.55 MPa	
Minimum differential pressure	0.05 MPa	
Maximum pressure reduction ratio	10:1	
Application temperature	5-80°C *	
Material	Body	Cast bronze
	Valve	Bronze
	Valve disc	Urethane rubber
	Valve seat	Stainless steel
	Diaphragm	NBR
	Cap	Bronze
	Plug	Stainless steel
Connection	JIS Rc screwed	

* Do not use the valve continuously at a temperature of 70°C or above.

■ Dimensions (mm) and Weights (kg)

Nominal size	d	L	H	H ₁	Weight
15A	Rc 1/2	80	193	42	1.8
20A	Rc 3/4	90	210	45	2.4
25A	Rc 1	100	230	50	3.3
31A	Rc 1-1/4	120	265	60	4.7
40A	Rc 1-1/2	150	315	62	8.2
50A	Rc 2	185	365	73	14.3

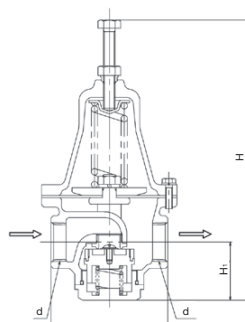

Flow Characteristic Chart

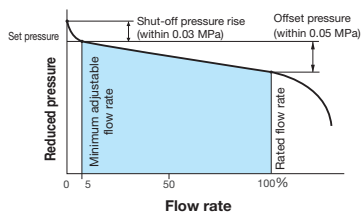

Pressure Characteristic Chart

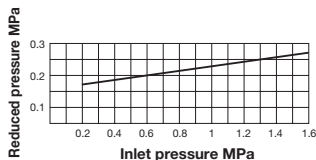

This chart shows variation in reduced pressure when the inlet pressure of 0.6 MPa is changed between 0.2 MPa and 1.6 MPa while the reduced pressure is set at 0.2 MPa.

■ GD-24 Nominal Sizes Selection Chart (For Water)

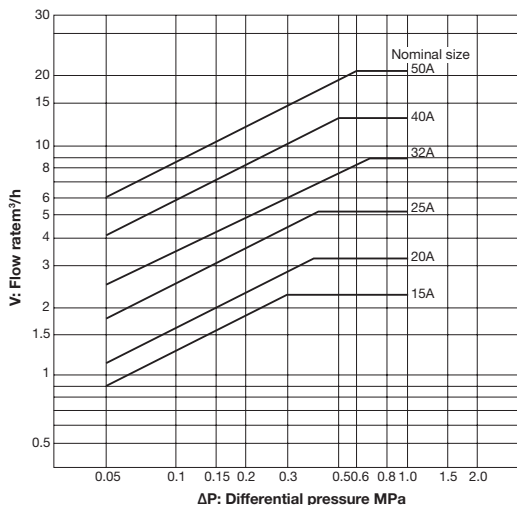

GD-200 Series

Direct type	Pilot type	Piston	Diaphragm
Bellows	Internal sensing	External sensing	Stainless steel
With handle	Built-in strainer	Low pressure	Remote
Valve leakage 0	JWWA	Nylon	



JWWA approval
(GD-200C-N)

■Features

1. Pressure balance structure can keep the reduced pressure at a constant level without being affected by inlet pressure.
2. Highly wear-resistance and durability of stainless steel made valve seat.
3. Maintenance and inspection can be conducted easily by disassembling simply from the upper side.
4. A rubber disc prevents leakage when the valve is closed.
5. The GD-200C provides excellent corrosion resistance due to inner and outer body surface coated with Nylon 11.
6. Horizontal or vertical installation is possible. (For above 80A, horizontal piping with upward posture.)



GD-200C



GD-200

■Specifications

Model	GD-200	GD-200C	GD-200C-N	GD-200H
Application	Cold and hot water, Oil (kerosene, heavy oils A and B), Air, Other non-dangerous fluids		Cold and hot water	Cold and hot water, Oil (kerosene, heavy oils A and B), Air, Other non-dangerous fluids
Inlet pressure	1.0 MPa or less			2.0 MPa or less
Reduced pressure	15A-80A (A) 0.05-0.25 MPa (B) 0.26-0.7 MPa 100A-150A (A) 0.05-0.25 MPa (B) 0.26-0.5 MPa			15A-50A (A) 0.05-0.25 MPa (B) 0.26-0.7 MPa (C) 0.5-1.0 MPa 65A-80A (A) 0.05-0.25 MPa (B) 0.26-0.7 MPa (C) 0.5-0.9 MPa 100A-150A (A) 0.05-0.25 MPa (B) 0.26-0.5 MPa (C) 0.5-0.75 MPa
Minimum differential pressure	0.05 MPa			
Maximum pressure reduction ratio	10:1			
Minimum adjustable flow rate	Water: 5 L/min Air: 10 m ³ /h (standard condition)		5 L/min	Water: 5 L/min Air: 10 m ³ /h (standard condition)
Application temperature	5-80°C	5-60°C		5-80°C
Fluid viscosity	600 cSt or less		-	600 cSt or less
Material	Body	Ductile cast iron		
	Valve seat	Stainless steel		
	Valve disc	NBR	EPDM or FKM	NBR
	Diaphragm	NBR	EPDM or FKM	NBR
Connection	JIS 10K FF flanged			JIS 20K RF flanged
Inside surface treatment of body	15A-100A: Electrodeposition coating 125-150A: Tar-based coating(black) or electrodeposition coating	Nylon 11 (inside and outside surfaces of body)		15A-100A: Electrodeposition coating 125-150A: Tar-based coating(black) or electrodeposition coating

- GD-200, 200C, 200H: Available with FKM type (except for GD-200H(C) of 65A to 150A).
- GD-200, 200C, 200H: Available with pressure gauge (JIS Rc1/4). JIS Rc3/8 is also available upon request.
- GD-200C-N: The size of pressure gauge port is Rc3/8. Available to manufacture with pressure gauge as option. (75 φ for 0.5 MPa and 1.0 MPa).

GD-200C-N



■ Dimensions (mm) and Weights (kg)

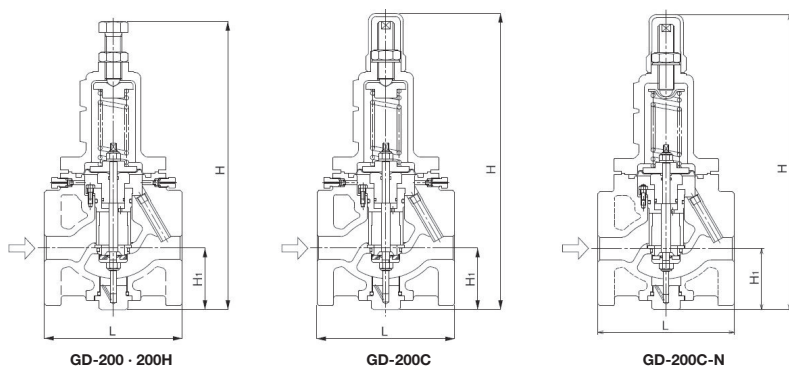

· Parts structure will be differ depend on size.

· GD-200, 200H

(mm)

Nominal size	L	H	H ₁	Weight	
				GD-200	GD-200H
15A	145	310	57	8.2	8.2
20A	150	310	57	8.2	8.2
25A	150	333	67	10.0	10.0
32A	195	397	76	17.3	17.3
40A	195	397	76	17.3	17.3
50A	195	415	81	19.2	19.2
65A	270	555	110	40.0	40.0
80A	270	582	125	43.7	43.7
100A	308	645	143	70.0	70.7
125A	380 (384)	849	179	144.0	145.0
150A	400 (404)	918	204	173.0	175.0

* The above values in parentheses are the dimensions of the GD-200H.

· GD-200C, 200C-N

(mm)

Nominal size	L	H	H ₁	Weight	
				GD-200C	GD-200C-N
15A	145	296	57	8.3	8.3
20A	150	296	57	8.3	8.3
25A	150	318	67	10.1	10.1
32A	195	398	76	17.4	17.4
40A	195	398	76	17.4	17.4
50A	195	412	81	19.3	19.3
65A	270	573 (575)	113 (110)	40.1	45.0
80A	270	598 (600)	128 (125)	43.8	50.0
100A	308	666 (670)	146 (143)	70.1	75.0
125A	380 (384)	875 (900)	182 (179)	144.1	145.0
150A	400 (404)	930 (960)	207 (204)	173.1	180.0

* The above values in parentheses are the dimensions of the GD-200C-N.

GD-20

Direct type	Pilot type	Piston	Diaphragm
Bellows	Internal sensing	External sensing	Stainless steel
With handle	Built-in strainer	Low pressure	Remote
Valve leakage 0	Nylon		

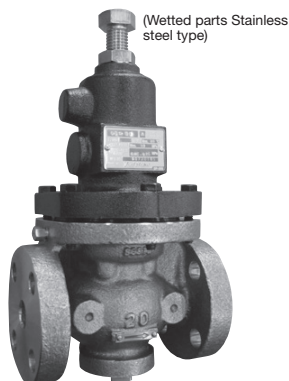

■ Features

1. Pressure balance structure can keep the reduced pressure at a constant level without being affected by inlet pressure.
2. Available with stainless steel wetted parts and all stainless steel made.
3. Valve disc prevents leakage when the valve is closed.
4. Horizontal or vertical installation is possible. (For above 80A, horizontal piping with upward posture)

■ Specifications

Model	Stainless steel wetted parts	All stainless steel
Application	Cold and hot water, Oil (kerosene, heavy oils A and B), Air, Other non-dangerous fluids	
Inlet pressure	1.0 MPa or less	
Reduced pressure	15A-80A (A) 0.05-0.25 MPa (B) 0.26-0.7 MPa 100A (A) 0.05-0.25 MPa (B) 0.26-0.5 MPa	15A-25A (A) 0.05-0.2 MPa (B) 0.21-0.6 MPa 32A-50A * (A) 0.05-0.2 MPa (B) 0.21-0.46 MPa
Minimum differential pressure	0.05 MPa	
Maximum pressure reduction ratio	10:1	
Application temperature	5-80°C	
Fluid viscosity	600 cSt or less	
Material	Body	Cast Stainless steel
	Valve seat	Stainless steel
	Valve disc	NBR
	Diaphragm	NBR
Connection	JIS 10K FF flanged	

* Please contact us about availability of 65A to 100A (May not available depend on reduce pressure).

· Available with FKM.

· GD-20

(mm)

Size	L	H		H ₁	Weight (kg)	
		Wetted parts stainless steel	All stainless steel		Wetted parts stainless steel	All stainless steel
15A	145	310	297	57	9.8	10.6
20A	150	310	297	57	9.8	10.6
25A	150	333	320	67	12.0	13.0
32A	195	397	397	76	20.7	22.5
40A	195	397	397	76	20.7	22.5
50A	195	415	415	81	23.0	25.0
65A	270	555	555	110	48.0	52.0
80A	270	582	582	125	52.4	56.8
100A	308	645	645	143	84.0	91.0

Flow Characteristic Chart

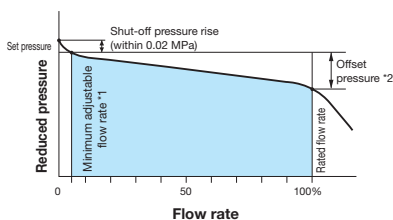

- *1 Minimum adjustable flow rate
 For water: 5 L/min
 For air: 10 m³/h (standard condition)

*2 Offset pressure

Nominal size	Pressure range	Offset pressure
15A-50A	(A), (B)	Setting range 0.05-0.7 MPa Within 0.05 MPa
	(C)	Setting range 0.5-1.0 MPa Within 0.11 MPa
65A,80A	(A), (B)	Setting range 0.05-0.7 MPa Within 0.05 MPa
	(C)	Setting range 0.5-0.9 MPa Within 0.11 MPa
100A	(A), (B)	Setting range 0.05-0.5 MPa Within 0.05 MPa
	(C)	Setting range 0.5-0.75 MPa Within 0.11 MPa
125A-150A	(A)	Setting range 0.05-0.25 MPa Within 0.05 MPa
	(B)	Setting range 0.26-0.5 MPa Within 0.07 MPa
	(C)	Setting range 0.5-0.75 MPa Within 0.11 MPa

Pressure Characteristic Chart

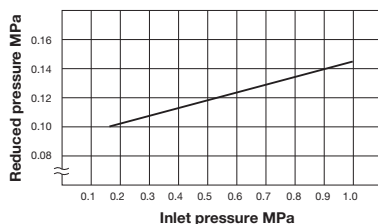

This chart shows variation in reduced pressure when the inlet pressure of 1.0 MPa is changed between 0.15 MPa and 1.0 MPa while the reduced pressure is set at 0.10 MPa.

■ Nominal Sizes Selection Chart (For Water)

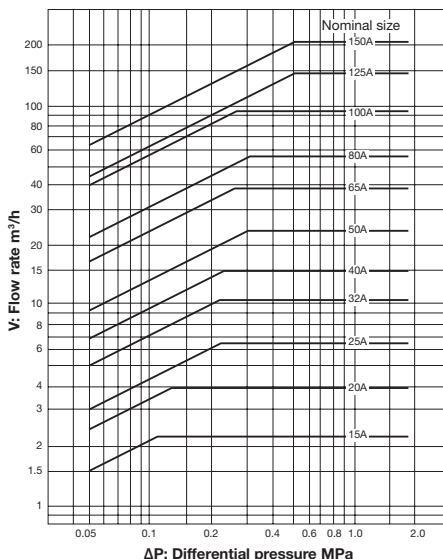

GD-200 series, GD-20 Nominal Sizes Selection Chart (For Air)

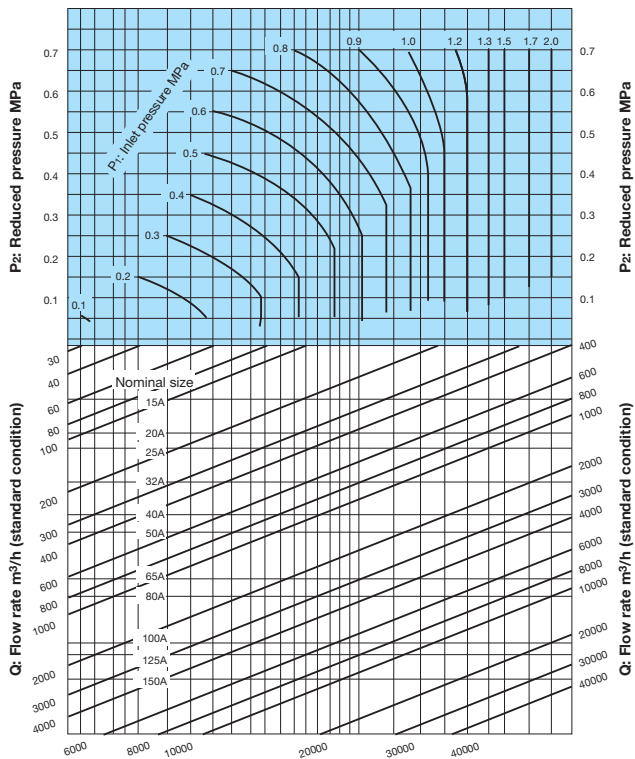

* Set the safety factor at 80 to 90%.

■GD-200 · GD-200H · GD-20 Flow Rate Table for Liquid

		(m ³ /h)										
P ₁ (MPa)	P ₂ (MPa)	15A	20A	25A	32A	40A	50A	65A	80A	100A	125A	150A
2.0	0.2-1.0	2.3	4.0	6.4	10.0	15.4	24.0	45.4	54.0	93.2	145.3	209.2
1.9	0.19-1.0	2.3	4.0	6.4	10.0	15.4	24.0	45.4	54.0	93.2	145.3	209.2
1.8	0.18-1.0	2.3	4.0	6.4	10.0	15.4	24.0	45.4	54.0	93.2	145.3	209.2
1.7	0.17-1.0	2.3	4.0	6.4	10.0	15.4	24.0	45.4	54.0	93.2	145.3	209.2
1.6	0.16-1.0	2.3	4.0	6.4	10.0	15.4	24.0	45.4	54.0	93.2	145.3	209.2
1.5	0.15-1.0	2.3	4.0	6.4	10.0	15.4	24.0	45.4	54.0	93.2	145.3	209.2
1.4	0.14-0.9	2.3	4.0	6.4	10.0	15.4	24.0	45.4	54.0	93.2	145.3	209.2
	1	2.3	4.0	6.4	10.0	15.4	24.0	45.4	54.0	93.2	130.0	187.1
1.3	0.15-0.8	2.3	4.0	6.4	10.0	15.4	24.0	45.4	54.0	93.2	145.3	209.2
	0.9	2.3	4.0	6.4	10.0	15.4	24.0	45.4	54.0	93.2	130.0	187.1
	1	2.3	4.0	6.4	10.0	15.4	24.0	42.0	54.0	93.2	112.5	162.1
1.2	0.12-0.7	2.3	4.0	6.4	10.0	15.4	24.0	45.4	54.0	93.2	145.3	209.2
	0.8	2.3	4.0	6.4	10.0	15.4	24.0	45.4	54.0	93.2	130.0	187.1
	0.9	2.3	4.0	6.4	10.0	15.4	24.0	42.0	54.0	93.2	112.5	162.1
	1	2.3	4.0	6.1	9.8	14.7	19.6	34.3	44.1	83.3	91.9	132.3
1.1	0.11-0.6	2.3	4.0	6.4	10.0	15.4	24.0	45.4	54.0	93.2	145.3	209.2
	0.7	2.3	4.0	6.4	10.0	15.4	24.0	45.4	54.0	93.2	130.0	187.1
	0.8	2.3	4.0	6.4	10.0	15.4	24.0	42.0	54.0	93.2	112.5	162.1
	0.9	2.3	4.0	6.1	9.8	14.7	19.6	34.3	44.1	83.3	91.9	132.3
1	1	2.2	3.5	4.3	6.9	10.4	13.9	24.3	31.2	58.9	65.0	93.6
	0.1-0.5	2.3	4.0	6.4	10.0	15.4	24.0	45.4	54.0	93.2	145.3	209.2
	0.6	2.3	4.0	6.4	10.0	15.4	24.0	45.4	54.0	93.2	130.0	187.1
	0.7	2.3	4.0	6.4	10.0	15.4	24.0	42.0	54.0	93.2	112.5	162.1
1	0.8	2.3	4.0	6.1	9.8	14.7	19.6	34.3	44.1	83.3	91.9	132.3
	0.9	2.2	3.5	4.3	6.9	10.4	13.9	24.3	31.2	58.9	65.0	93.6
	0.09-0.4	2.3	4.0	6.4	10.0	15.4	24.0	45.4	54.0	93.2	145.3	209.2
	0.5	2.3	4.0	6.4	10.0	15.4	24.0	45.4	54.0	93.2	130.0	187.1
0.9	0.6	2.3	4.0	6.4	10.0	15.4	24.0	42.0	54.0	93.2	112.5	162.1
	0.7	2.3	4.0	6.1	9.8	14.7	19.6	34.3	44.1	83.3	91.9	132.3
	0.8	2.2	3.5	4.3	6.9	10.4	13.9	24.3	31.2	58.9	65.0	93.6
	0.08-0.3	2.3	4.0	6.4	10.0	15.4	24.0	45.4	54.0	93.2	145.3	209.2
0.8	0.4	2.3	4.0	6.4	10.0	15.4	24.0	45.4	54.0	93.2	130.0	187.1
	0.5	2.3	4.0	6.4	10.0	15.4	24.0	42.0	54.0	93.2	112.5	162.1
	0.6	2.3	4.0	6.1	9.8	14.7	19.6	34.3	44.1	83.3	91.9	132.3
	0.7	2.2	3.5	4.3	6.9	10.4	13.9	24.3	31.2	58.9	65.0	93.6
0.7	0.07-0.2	2.3	4.0	6.4	10.0	15.4	24.0	45.4	54.0	93.2	145.3	209.2
	0.3	2.3	4.0	6.4	10.0	15.4	24.0	45.4	54.0	93.2	130.0	187.1
	0.4	2.3	4.0	6.4	10.0	15.4	24.0	42.0	54.0	93.2	112.5	162.1
	0.5	2.3	4.0	6.1	9.8	14.7	19.6	34.3	44.1	83.3	91.9	132.3
	0.6	2.2	3.5	4.3	6.9	10.4	13.9	24.3	31.2	58.9	65.0	93.6
0.6	0.1	2.3	4.0	6.4	10.0	15.4	24.0	45.4	54.0	93.2	145.3	209.2
	0.2	2.3	4.0	6.4	10.0	15.4	24.0	45.4	54.0	93.2	130.0	187.1
	0.4	2.3	4.0	6.1	9.8	14.7	19.6	34.3	44.1	83.3	91.9	132.3
	0.5	2.2	3.5	4.3	6.9	10.4	13.9	24.3	31.2	58.9	65.0	93.6
0.5	0.1	2.3	4.0	6.4	10.0	15.4	24.0	45.4	54.0	93.2	130.0	187.1
	0.2	2.3	4.0	6.4	10.0	15.4	24.0	42.0	54.0	93.2	112.5	162.1
	0.3	2.3	4.0	6.1	9.8	14.7	19.6	34.3	44.1	83.3	91.9	132.3
	0.4	2.2	3.5	4.3	6.9	10.4	13.9	24.3	31.2	58.9	65.0	93.6
0.4	0.1	2.3	4.0	6.4	10.0	15.4	24.0	42.0	54.0	93.2	112.5	162.1
	0.2	2.3	4.0	6.1	9.8	14.7	19.6	34.3	44.1	83.3	91.9	132.3
	0.3	2.2	3.5	4.3	6.9	10.4	13.9	24.3	31.2	58.9	65.0	93.6
0.3	0.1	2.3	4.0	6.1	9.8	14.7	19.6	34.3	44.1	83.3	91.9	132.3
	0.2	2.2	3.5	4.3	6.9	10.4	13.9	24.3	31.2	58.9	65.0	93.6
0.2	0.1	2.2	3.5	4.3	6.9	10.4	13.9	24.3	31.2	58.9	65.0	93.6
0.1	0.05	1.5	2.5	3.1	4.9	7.4	9.8	17.2	22.1	41.7	45.9	66.2

GD-41,43,41N,43N



JWWA approval
(GD-41N, GD-43N)

Direct type	Pilot type	Piston	Diaphragm
Bellows	Internal sensing	External sensing	Stainless steel
With handle	Built-in strainer	Low pressure	Remote
Valve leakage 0	JWWA	Nylon	

■Features

- Space saving and resource saving are achieved (used materials are shown on the body and lower cap, thus separate collection of parts for resource recycling is easy).
- Stainless steel (SCS14A and SUS316) is used for wetted parts, improving corrosion resistance.
- PTFE covers diaphragm contact surface to fluid, making the diaphragm less liable to deteriorate and highly durable.
- Special fluorine-contained rubber parts are resistant to corrosion.
- Pressure balance structure can keep the reduced pressure at a constant level without being affected by inlet pressure.
- Closed structure keeps fluid from flowing to outside even if the diaphragm is damaged or broken.
- Safe fluorine grease is applied to O-ring.
- Can be applied to piping washing, system washing, sterilization washing and steam for sterilization.



GD-41, 41N

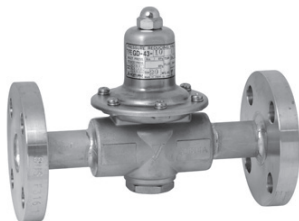

GD-43, 43N

■Specifications

Model	GD-41	GD-43-10	GD-43-20	GD-41N	GD-43N-10	GD-43N-20
Application	Cold and hot water Steam for washing or sterilization					
Inlet pressure	0.07-2.0 MPa (0.2 MPa or less for steam for washing or sterilization) *2					
Reduced pressure	(A) Yellow spring: 0.02-0.1 MPa <Standard setting: 0.05 MPa> (B) Red spring: 0.1-0.25 MPa <Standard setting: 0.1 MPa> (C) Black spring: 0.25-0.5 MPa <Standard setting: 0.3 MPa>					
Minimum differential pressure	0.05 MPa					
Maximum pressure reduction ratio	Cold and hot water: 10:1 5-90°C					
Fluid temperature	(The maximum temperature of steam for washing or sterilization is 130°C. Allow an interval of at least four hours between steam flows.)					
Material	Body	Cast Stainless steel (SCS14A)				
	Valve disc	Special synthetic rubber (special FKM)				
	Diaphragm	Heat-resistant synthetic rubber and PTFE (PTFE applied to wetted face)				
Connection	JIS Rc screwed	JIS 10K FF flanged	JIS 20K RF flanged	JIS Rc screwed	JIS 10K FF flanged	JIS 20K RF flanged

*1 Available with JIS 5K and JIS 16K for GD-43 and GD-43N.

*2 The inlet pressure of the GD-43-10 and GD-43N-10 is 0.07 to 1.0 MPa.

· If using for washing steam or sterilization steam, be sure that maximum temperature is 130°C and avoid continuous use for more than 30 minutes.

· Available with pressure gauge (JIS Rc 1/8 screwed).



■ Dimensions (mm) and Weights (kg)

• GD-41 · 41N

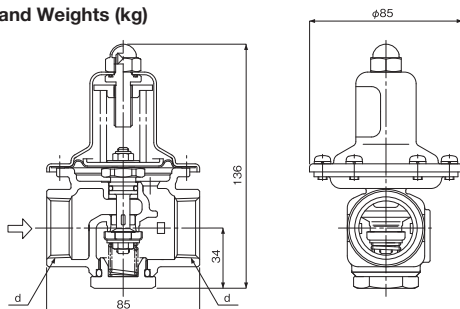

Nominal size	d	Weight
15A	Rc 1/2	1.2
20A	Rc 3/4	1.1
25A	Rc 1	1.0

* All dimensions are same except connection size.

• GD-43 · 43N

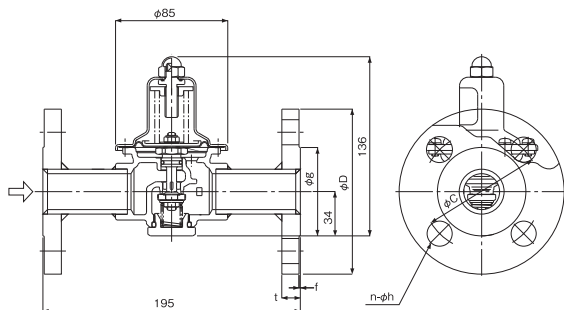

* All dimensions are same except flange size.

(mm)

Size	JIS 20KRF flange						Weight (kg)
	D	C	g	t	f	n-h	
15A	95	70	51	14 (12)	1	4-15	2.8 (2.6)
20A	100	75	56	16 (14)	1	4-15	3.0 (2.9)
25A	125	90	67	16 (14)	1	4-19	4.0 (3.7)

* The values in parenthesis are the weights of the GD-43-10, GD-43N-10.

GD-41G, GD-43G

Direct type	Pilot type	Piston	Diaphragm
Bellows	Internal sensing	External sensing	Stainless steel
With handle	Built-in strainer	Low pressure	Remote
Valve leakage 0	Nylon		

■Features

- Space saving and resource saving are achieved (used materials are shown on the body and lower cap, thus separate collection of parts for resource recycling is easy).
- Stainless steel (SCS14A and SUS316) is used for wetted parts, improving corrosion resistance.
- PTFE covers diaphragm contact surface to fluid, making the diaphragm less liable to deteriorate and highly durable.
- Special fluorine-contained rubber parts are resistant to corrosion.
- Pressure balance structure can keep the reduced pressure at a constant level without being affected by inlet pressure.
- Can be applied to piping washing, system washing, sterilization washing and steam for sterilization.
- Horizontal or vertical installation is available.



GD-41G

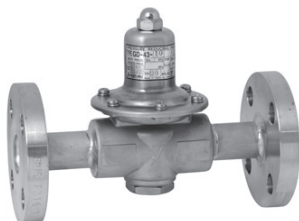

GD-43G

■Specifications

Model	GD-41G	GD-43G-10	GD-43G-20
Application	Air, Carbon dioxide gas, Nitrogen gas Steam for washing or sterilization		
Inlet pressure	0.07-2.0 MPa *1 (0.2 MPa or less for steam for washing or sterilization)		
Reduced pressure	(A) Yellow spring: 0.02-0.1 MPa <Standard setting: 0.05 MPa> (B) Red spring: 0.1-0.25 MPa <Standard setting: 0.1 MPa> (C) Black spring: 0.25-0.5 MPa <Standard setting: 0.3 MPa>		
Minimum differential pressure	0.05 MPa		
Maximum pressure reduction ratio	20:1		
Fluid temperature	5-90°C (The maximum temperature of steam for washing or sterilization is 130°C. Allow an interval of at least four hours between steam flows.)		
Material	Body	Cast Stainless steel (SCS14A)	
	Valve disc	Special synthetic rubber (special FKM)	
	Diaphragm	Heat-resistant synthetic rubber and PTFE (PTFE applied to wetted face)	
Connection	JIS Rc screwed	JIS 10K FF flanged	JIS 20K RF flanged

*1 The inlet pressure of GD-43G-10 is 0.07 to 1.0 MPa.

- If using for washing steam or sterilization steam, be sure that maximum temperature is 130°C and avoid continuous use for more than 30 minutes.
- Available with pressure gauge (JIS Rc 1/8 screwed).



■ Dimensions (mm) and Weights (kg)

• GD-41G

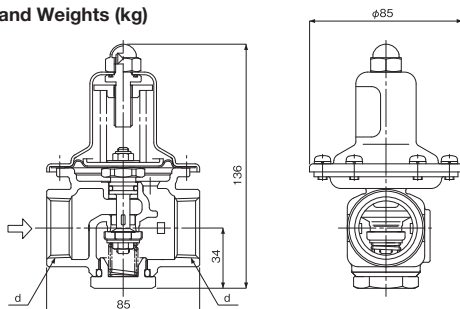

Nominal size	d	Weight
15A	Rc 1/2	1.2
20A	Rc 3/4	1.1
25A	Rc 1	1.0

* All dimensions are same except connection size.

• GD-43G

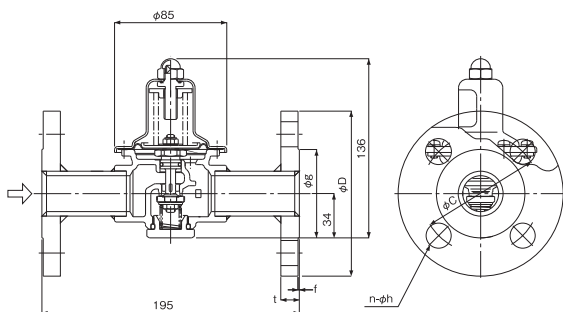

* All dimensions are same except flange size.

(mm)

Nominal Size	JIS 20KRF flange						Weight (kg)
	D	C	g	t	f	n-h	
15A	95	70	51	14 (12)	1	4-15	2.8 (2.6)
20A	100	75	56	16 (14)	1	4-15	3.0 (2.9)
25A	125	90	67	16 (14)	1	4-19	4.0 (3.7)

* The values in parentheses are the weights of the GD-43G-10.

Specifications Selection Chart

(Cold and hot water)

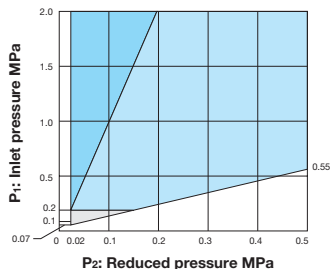

(Air, carbon dioxide gas, and nitrogen gas)

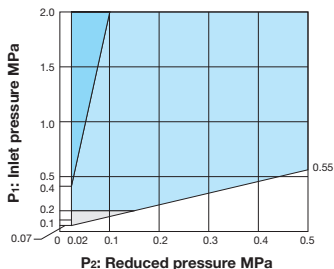

- Controllable range
- Range requiring two-stage pressure reduction
- Range controllable and also compatible with steam for washing or sterilization

Flow Characteristic Chart

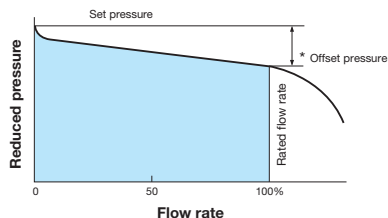

* Offset pressure

Set pressure	Offset pressure
0.2 MPa or less	Within 0.05 MPa
More than 0.2 MPa	Within 0.08 MPa

Pressure Characteristic Chart

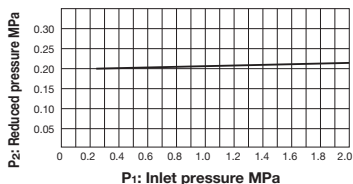

This chart shows variation in reduced pressure when the inlet pressure of 0.25 MPa is changed to 2.0 MPa while the reduced pressure is set at 0.20 MPa.

■ Nominal Sizes Selection Chart (For Air)

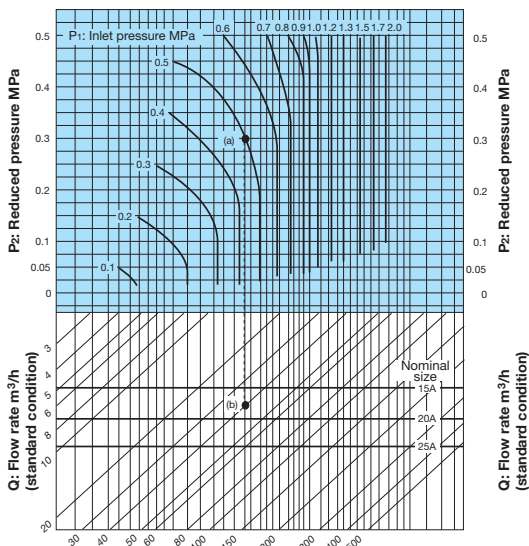

[Example]

When selecting the nominal size of a pressure reducing valve whose inlet pressure (P_1), reduced pressure (P_2), and flow rate are 0.5 MPa, 0.3 MPa, and 40 m^3/h (standard condition), respectively, first find intersection point (a) of the inlet pressure of 0.5 MPa and the reduced pressure of 0.3 MPa. Trace down vertically from this intersection point to find intersection point (b) with the flow rate of 40 m^3/h (standard condition). Since intersection point (b) lies between nominal sizes 15A and 20A, select the larger one, 20A.

* Set the safety factor at 80 to 90%.

■ Nominal Sizes Selection Chart (For Cold and Hot Water)

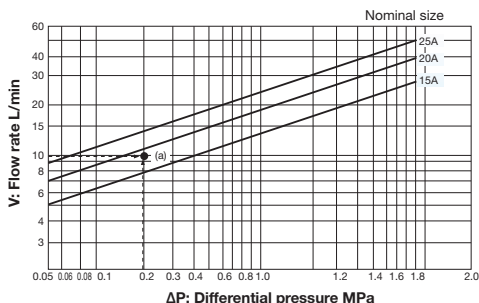

[Example]

When selecting the nominal size of a pressure reducing valve whose inlet pressure (P_1), reduced pressure (P_2), and flow rate are 0.5 MPa, 0.3 MPa, and 10 L/min, respectively, trace up vertically from the 0.2 MPa point of differential pressure before and after the valve to find intersection point (a) with the flow rate of 10 L/min. Since intersection point (a) is between nominal sizes 15A and 20A, select the larger one, 20A.

GD-7

Direct type	Pilot type	Piston	Diaphragm
Bellows	Internal sensing	External sensing	Stainless steel
With handle	Built-in strainer	Low pressure	Remote
Valve leakage 0	Nylon		



■Features

1. Simple in structure, less prone to fail and easy to maintain.
2. Insusceptible to effect of inlet pressure fluctuation due to dual valve.
3. Outstanding performance as a pressure reducer for lubricant grease and heavy oil.

■Specifications

Model		GD-7	
Application		Cold and hot water, Oil, Other non-dangerous fluids	
Nominal size		20A-50A	65A-150A
Inlet pressure		0.1-1.0 MPa	
Reduced pressure		(A) 0.05-0.25 MPa (B) 0.25-0.45 MPa (C) 0.45-0.7 MPa	(A) 0.05-0.2 MPa (B) 0.2-0.5 MPa (C) 0.5-0.7 MPa
		70% or less of inlet pressure (gauge pressure)	
Minimum differential pressure		0.05 MPa	
Maximum differential pressure		0.7 MPa	
Maximum pressure reduction ratio		10:1	
Application temperature		5-80°C *1	
Fluid viscosity		700 cSt or less	
Material	Body	Cast iron	
	Valve, valve seat	Phosphor bronze *2	
	Spindle	Stainless steel	
	Piston	Bronze	
Connection		JIS 10K FF flanged	

*1 Available with withstanding up to 120°C.

*2 Available with stainless steel made valve and valve seat.

· Available with the GD-7H, made of cast steel, with inlet pressure of 2.0 MPa or less and reduced pressure of 0.7 to 1.4 MPa.

· Valve seat leakage(L/ml)

Nominal size	20	25	32	40	50	65	80	100	125	150
Leakage	0.16	0.2	0.25	0.32	0.4	0.52	0.64	0.8	1.0	1.2

■Dimensions (mm) and Weights (kg)

Nominal size	L	H	H ₁	Weight
20A	170	535	95	20
25A	170	535	95	22
32A	180	545	100	23
40A	180	545	100	23
50A	180	565	110	26
65A	215	680	125	41
80A	260	700	135	51
100A	300	750	160	66
125A	360	810	190	90
150A	382	875	220	129

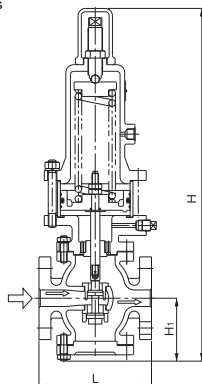

Structure is different depends on nominal size.

Specifications Selection Chart

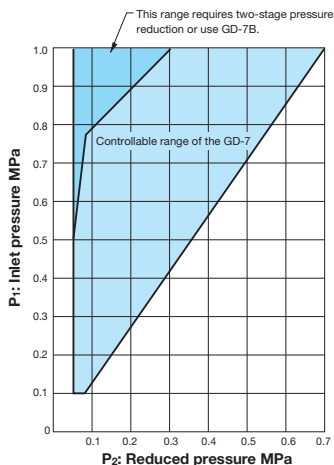

Flow Characteristic Chart

Nominal size	Shut-off pressure rise
20A-50A	Within 10% of set pressure
65A-100A	Within 15% of set pressure
125A-150A	Within 20% of set pressure

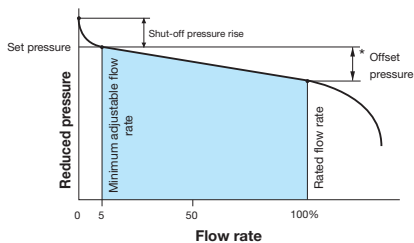

* Offset pressure

Nominal size	Offset pressure MPa	
	GD-7	GD-7H
65A-100A	Within 0.08	Within 0.23
125A-150A	Within 0.11	Within 0.18

Pressure Characteristic Chart

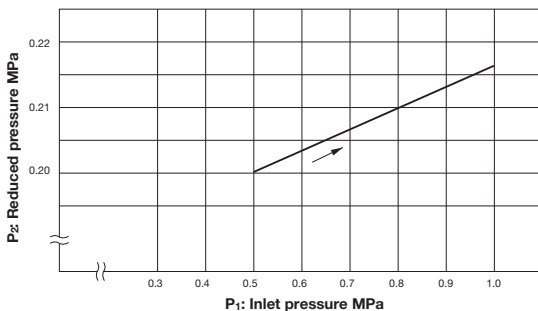

This chart shows variation in reduced pressure when the inlet pressure of 0.5 MPa is changed between 0.5 MPa and 1.0 MPa while the reduced pressure is set at 0.2 MPa.

■ Nominal Sizes Selection Chart (For Water)

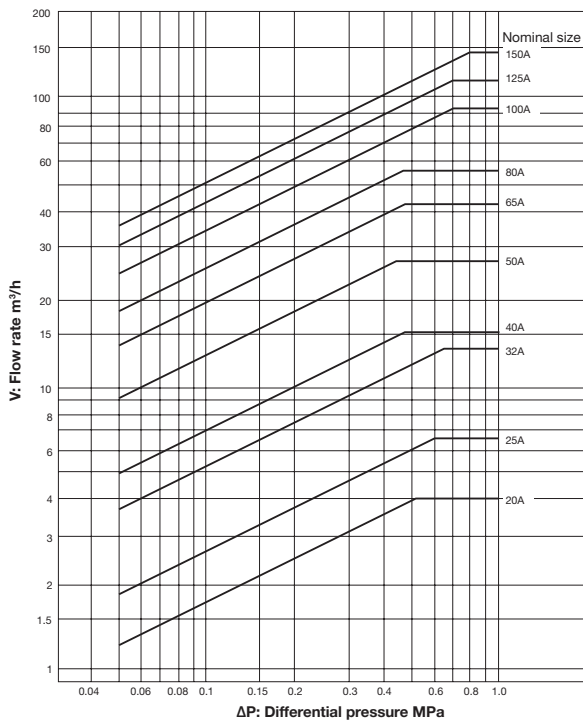

GD-7B

Direct type	Pilot type	Piston	Diaphragm
Bellows	Internal sensing	External sensing	Stainless steel
With handle	Built-in strainer	Low pressure	Remote
Valve leakage 0	Nylon		



■Features

1. Simple in structure, less prone to fail and easy to maintain.
2. Outstanding performance as a pressure reducer for lubricant grease and heavy oil.
3. Pressure balance structure provides stable reduced pressure to inlet pressure and increased maximum pressure ratio.

■Specifications

Model	GD-7B	
Application	Cold and hot water, Oil, Other non-dangerous fluids	
Nominal size	20A-50A	65A-150A
Inlet pressure	0.1-1.0 MPa	
Reduced pressure	(A) 0.05-0.25 MPa (B) 0.25-0.45 MPa (C) 0.45-0.7 MPa	(A) 0.05-0.2 MPa (B) 0.2-0.5 MPa (C) 0.5-0.7 MPa
	85% or less of inlet pressure (gauge pressure)	
Minimum differential pressure	0.05 MPa	
Maximum pressure reduction ratio	20A-50A: 20:1 65A-150A: 15:1	
Application temperature	5-80°C *	
Valve seat leakage	None	
Fluid viscosity	700 cSt or less	
Material	Body	Cast iron
	Valve disc	Stainless steel (NBR disc incorporated)
	Valve seat	Stainless steel
	Spindle	Stainless steel
	Piston	Bronze
Connection	JIS 10K FF flanged	

* Available with withstanding up to 120°C.

· Available with the GD-7BH, made of cast steel, with inlet pressure of 2.0 MPa or less and reduced pressure of 0.7 to 1.6 MPa.

■Dimensions (mm) and Weights (kg)

Nominal size	L	H	H ₁	Weight
20A	170	535	95	20
25A	170	535	95	22
32A	180	545	100	23
40A	180	545	100	23
50A	180	565	110	26
65A	215	680	125	41
80A	260	705	140	51
100A	300	755	165	66
125A	360	815	195	90
150A	382	885	225	129

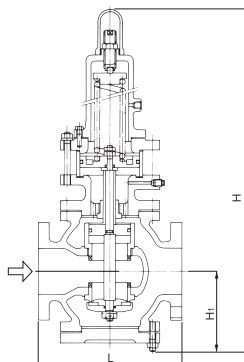

Structure is different depends on nominal size.

Specifications Selection Chart

• Nominal sizes 20A to 50A

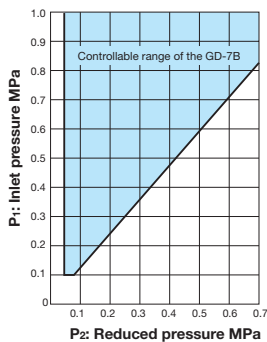

• Nominal sizes 65A to 150A

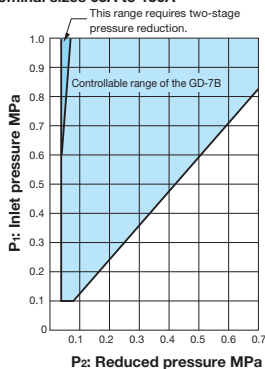

Flow Characteristic Chart

Nominal size	Shut-off pressure rise	
	GD-7B	GD-7BH
20A-50A	Within 10% of set pressure	Within 15% of set pressure
65A-150A	Within 15% of set pressure	Within 15% of set pressure

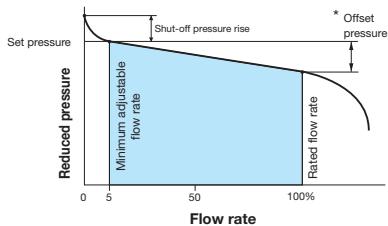

Nominal size	Offset pressure MPa	
	GD-7B	GD-7BH
20A-50A	Within 0.08	Within 0.23
65A-150A	Within 0.11	Within 0.18

Nominal Sizes Selection Chart (For Water)

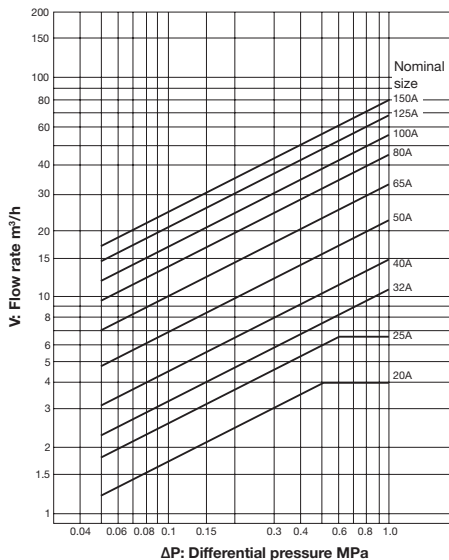

GD-6

Direct type	Pilot type	Piston	Diaphragm
Bellows	Internal sensing	External sensing	Stainless steel
With handle	Built-in strainer	Low pressure	Remote
Valve leakage 0	Nylon		



■Features

1. High accurate controllability of reduced pressure even at small flow rate.
2. Simple in structure, less prone to fail and easy to maintain.
3. Compact and lightweight.

■Specifications

Model	GD-6	
Application	Cold and hot water, Oil, Air, Other non-dangerous fluids	
Inlet pressure	0.1-1.0 MPa	
Reduced pressure	(A) 0.02-0.1 MPa (Nameplate color: yellow) (B) 0.1-0.4 MPa (Nameplate color: blue)	
Minimum differential pressure	0.05 MPa	
Maximum pressure reduction ratio	10:1	
Application temperature	5-80°C	
Valve seat leakage	None	
Fluid viscosity	300 cSt or less	
Material	Body	Ductile cast iron *1
	Valve, valve seat	Brass and bronze (FKM disc incorporated) *2
	Diaphragm	Stainless steel
Connection	JIS Rc screwed	

*1 Available with stainless steel wetted parts and all stainless steel made on request.

*2 Available with stainless steel made valve disc and valve seat on request. Also available with PTFE disc on request.

- Available with anticorrosive (fluororesin-coated) type on request.

■Dimensions (mm) and Weights (kg)

Nominal size	d	L	H	H ₁	E	Weight
10A	Rc 3/8	165	243	57	155	5.5
15A	Rc 1/2	165	243	57	155	5.5
20A	Rc 3/4	185	267	76	175	8.2
25A	Rc 1	185	267	76	175	8.2

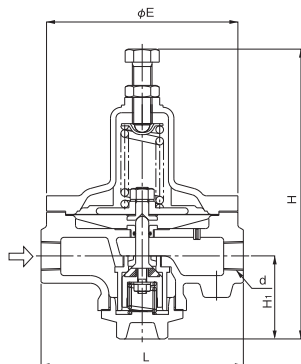

Flow Characteristic Chart

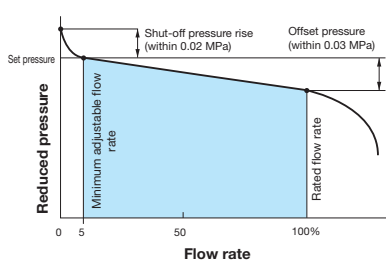

Pressure Characteristic Chart

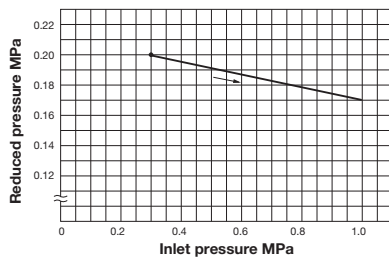

This chart shows variation in reduced pressure when the inlet pressure of 0.3 MPa is changed between 0.3 MPa and 1.0 MPa while the reduced pressure is set at 0.2 MPa.

GD-6 Nominal Sizes Selection Chart (For Water)

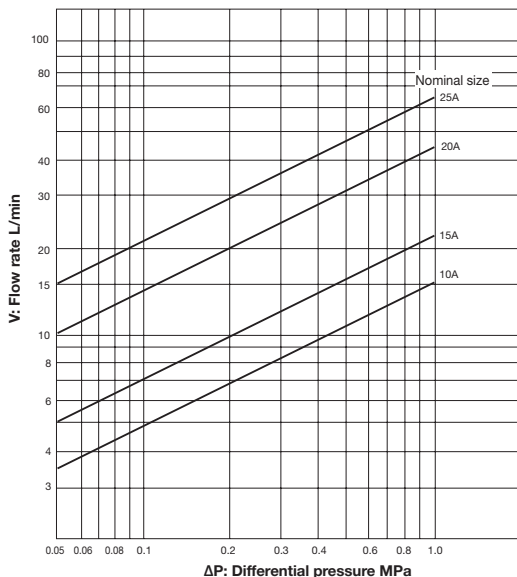

GD-6 Nominal Sizes Selection Chart (For Air)

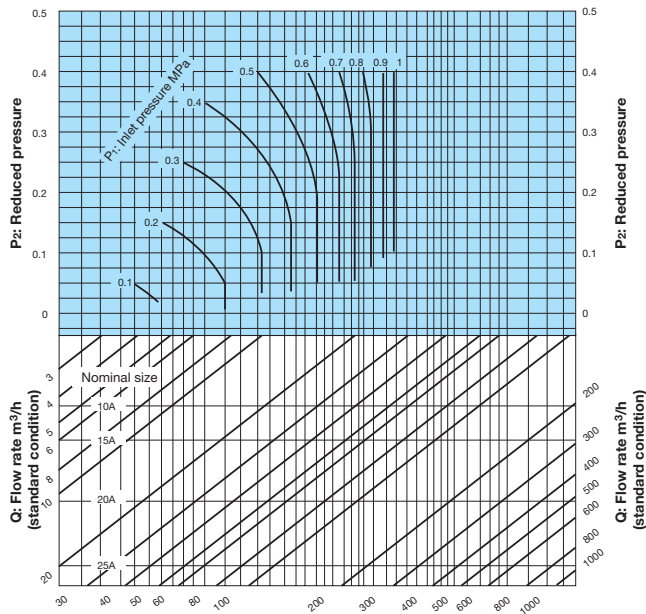

* Set the safety factor at 80 to 90%.

GD-8N

Direct type	Pilot type	Piston	Diaphragm
Bellows	Internal sensing	External sensing	Stainless steel
With handle	Built-in strainer	Low pressure	Remote
Valve leakage 0	Nylon		

■ Features

1. Excellent corrosion-resistant and durability, since all wetted parts are stainless steel (SUS316).
2. The parts are degreased and non-grease.
3. Able to install pressure gauge for sensing the outlet pressure.

■ Specifications

Model	GD-8N	
Application	Pure water, Cold and hot water, Air, Nitrogen gas, Carbon dioxide gas, Argon gas	
Inlet pressure	0.1-1.0 MPa	
Reduced pressure	0.05-0.7 MPa *1	
Adjusted reduced pressure	85% or less of inlet pressure (gauge pressure)	
Application temperature	5-60°C	
Material	Body	Stainless steel (SUS316)
	Valve	Stainless steel
	Diaphragm	Fluororesin
	Pressure-resistant diaphragm	FKM
Structure	Non-relief type	
Connection	JIS Rc screwed	

- *1 Available with reduced pressure of 0.02 to 0.2 MPa (for low pressure)
 · Pressure gauge connection port is JIS Rc 1/4 screwed.
 (Select from MAX 1.0 MPa, 0.4 MPa, 0.2 MPa)
 · Available with dedicated brackets.

■ Dimensions (mm) and Weights (kg)

Nominal size	d	L	H	H ₁	Weight
6A	Rc 1/8	40	80.5	24	0.36
8A	Rc 1/4	40	80.5	24	0.36
10A	Rc 3/8	58	101.5	33.5	0.73
15A	Rc 1/2	58	101.5	33.5	0.73

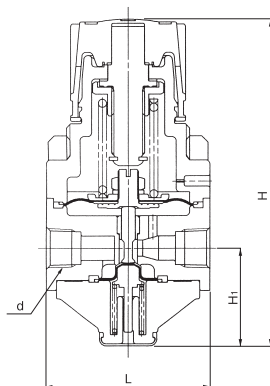

Structure is different depends on nominal size.

■ GD-8N Selection Chart

Flow Characteristic Chart and Cv Value

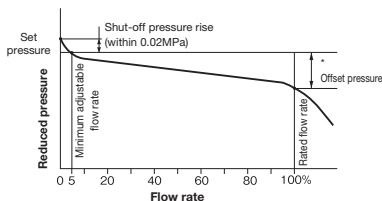

* Offset pressure and Cv value

Nominal size	Reduced pressure	Offset pressure	Cv value
6A-8A	0.02-0.2 MPa	Within 0.03MPa	0.1
	0.05-0.7 MPa	Within 0.05MPa	0.1
10A-15A	0.02-0.2 MPa	Within 0.03MPa	0.2
	0.05-0.7 MPa	Within 0.05MPa	0.2

GP-50

Direct type	Pilot type	Piston	Diaphragm
Bellows	Internal sensing	External sensing	Stainless steel
With handle	Built-in strainer	Low pressure	Remote
Valve leakage 0	Nylon		



■Features

1. Pilot operated type with large flow rate.
2. Smaller offset.
3. Able to maintain reduced pressure stable.

■Specifications

Model		GP-50
Application		Cold and hot water
Inlet pressure		0.14-1.0 MPa
Reduced pressure		0.07-0.2 MPa 0.2-0.4 MPa 0.4-0.7 MPa
Application temperature		0-70°C
Minimum differential pressure		0.07 MPa
Maximum pressure reduction ratio		10:1
Material	Body	Cast iron
	Valve	NBR · Bronze
	Valve seat	Bronze
Connection		JIS 10K RF flanged

■Dimensions (mm) and Weights (kg)

Nominal size	L	H	H ₁	Weight
125A	420	585	145	130
150A	450	623	153	170
200A	600	765	220	270
250A	700	835	250	400
300A	800	895	295	510

■Minimum Adjustable Flow Rate

Nominal size	125A	150A	200A	250A	300A
Minimum adjustable flow rate	10% of rated flow rate				

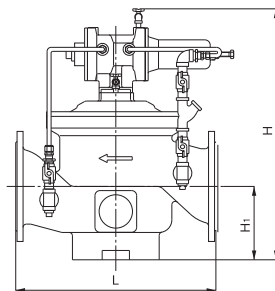

Flow Characteristic Chart

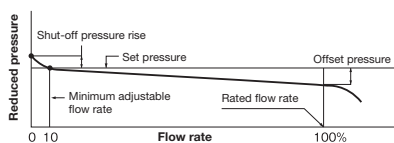

Pressure range	Shut-off pressure rise
0.07-0.2 MPa	Within 0.05 MPa
0.2-0.4 MPa	Within 0.07 MPa
0.4-0.7 MPa	Within 0.11 MPa
Offset pressure	Within 10% of set pressure (Minimum 0.04 MPa)

Nominal Size Selection Chart

· Rated flow rate

Nominal size	125A	150A	200A	250A	300A
Flow rate (m ³ /h)	145	204	355	547	800

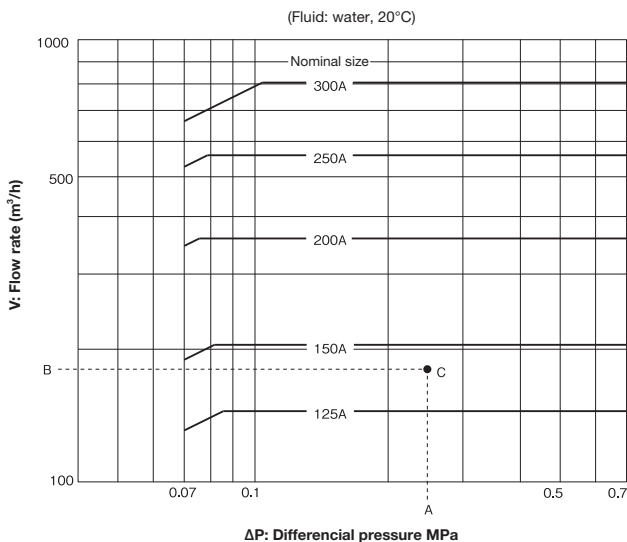

· How to use the chart & Example

Find the intersection point (C) of differential pressure (A) and requiring flow rate (B). Select the size above point (C). In this case select 150A.

* Let the fluid velocity inside pipe be smaller than 3m/sec.

GD-26G,27G

Direct type	Pilot type	Piston	Diaphragm
Bellows	Internal sensing	External sensing	Stainless steel
With handle	Built-in strainer	Low pressure	Remote
Valve leakage 0	Nylon		

■Features

1. Corrosion-resistant materials are used for wetted parts.
2. Reduced noise.
3. Pressure balance structure can keep the reduced pressure at a constant level without being affected by inlet pressure.
4. Maintenance and inspection can be conducted easily by disassembling simply from the upper side.
5. Compact and lightweight, easy to handle on piping.



GD-26G



GD-27G

■Specifications

Model	GD-26G	GD-27G
Application	Air, Other non-dangerous fluids *	
Inlet pressure	1.0 MPa or less	
Reduced pressure	(A) 0.05-0.35 MPa (B) 0.3-0.7 MPa	
Fluid temperature	5-90°C	
Minimum differential pressure	0.05 MPa	
Maximum pressure reduction ratio	10:1	
Material	Body	Bronze
	Valve seat	Bronze
	Valve disc	EPDM
	Diaphragm	EPDM
Connection	JIS Rc screwed	JIS 10K FF flanged

* Please contact us when using for gas containing oil.

· A strainer (40 mesh) is incorporated in 15A to 50A.

· 65A to 150A do not incorporate strainers.

· Pressure gauge connection port is JIS Rc 1/8.



■ Dimensions (mm) and Weights (kg)

· GD-26G

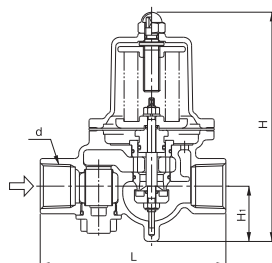

Nominal size	d	L	H	H ₁	Weight
15A	Rc 1/2	115	159.5	37.5	1.6
20A	Rc 3/4	120	159.5	38.5	1.7
25A	Rc 1	135	170	41	2.1
32A	Rc 1-1/4	180	224	57	4.0
40A	Rc 1-1/2	180	224	57	4.4
50A	Rc 2	200	239.5	61	6.5

· GD-27G

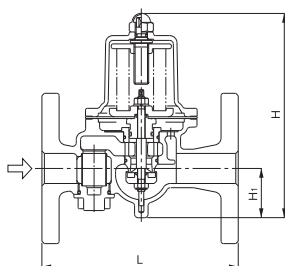

25A-50A

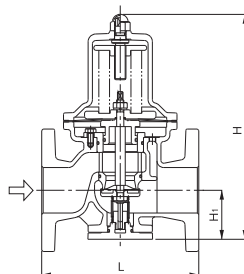

65A-100A

Nominal size	L	H	H ₁	Weight
25A	160	170	41	5.1
32A	200	224	57	7.5
40A	200	224	57	7.7
50A	220	239.5	61	10.9
65A	220	329	77	20.0
80A	230	345	82	22.0
100A	270	412	94	33.0

GD-26GS,27GS

Direct type	Pilot type	Piston	Diaphragm
Bellows	Internal sensing	External sensing	Stainless steel
With handle	Built-in strainer	Low pressure	Remote
Valve leakage 0	Nylon		



GD-26GS



GD-27GS

■Features

1. Corrosion-resistant materials are used for wetted parts.
2. Reduced noise.
3. Pressure balance structure can keep the reduced pressure at a constant level without being affected by inlet pressure.
4. Maintenance and inspection can be conducted easily by disassembling simply from the upper side.
5. Compact and lightweight, easy to handle on piping.

■Specifications

Model	GD-26GS	GD-27GS
Application	Air, Other non-dangerous fluids *	
Inlet pressure	1.0 MPa or less	
Reduced pressure	(A) 0.05-0.35 MPa (B) 0.3-0.7 MPa	
Application temperature	5-90°C	
Minimum differential pressure	0.05 MPa	
Maximum pressure reduction ratio	10:1	
Material	Body	Cast stainless steel
	Valve seat	Cast stainless steel
	Valve disc	EPDM
	Diaphragm	EPDM
Connection	JIS Rc screwed	JIS 10K FF flanged

* Please contact us when using for gas containing oil

· A strainer (40 mesh) is incorporated in 15A to 50A.

· Pressure gauge connection port is JIS Rc 1/4.
(Select from $\phi 42$ -MAX 1.0 MPa, 0.4 MPa, and 0.2 MPa).

· Available with FKM.



■Dimensions (mm) and Weights (kg)

· GD-26GS

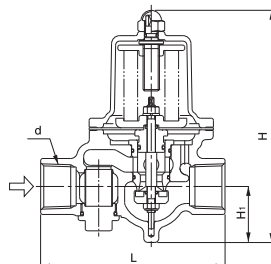

Nominal size	d	L	H	H ₁	Weight
20A	Rc 3/4	135	170	41	2.2
25A	Rc 1	135	170	41	2.2
32A	Rc 1-1/4	180	224	57	4.7
40A	Rc 1-1/2	180	224	57	4.5
50A	Rc 2	200	239.5	61	6.5

· GD-27GS

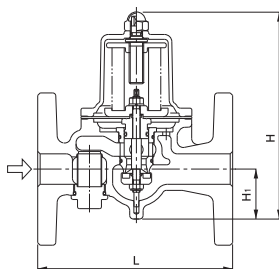

25A-50A

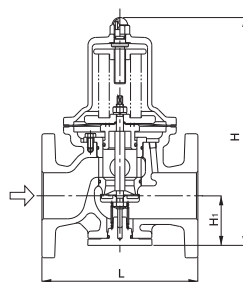

65A-100A

Nominal size	L	H	H ₁	Weight
20A	160	170	41	3.9
25A	160	170	41	4.8
32A	200	224	57	8.0
40A	200	224	57	8.3
50A	220	239.5	61	10.8
65A	220	329	77	20.6
80A	230	345	82	22.0
100A	270	412	94	34.5

Pressure Characteristic Chart

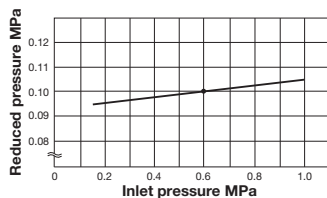

This chart shows variation in reduced pressure when the inlet pressure of 0.6 MPa is changed between 0.15 MPa and 1.0 MPa while the reduced pressure is set at 0.1 MPa.

Flow Characteristic Chart

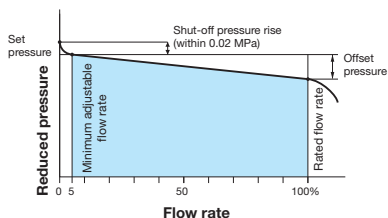

Nominal size	Pressure range	Offset pressure
15-100A	(A) 0.05-0.35 MPa	Within 0.05 MPa
	(B) 0.3-0.7 MPa	Within 0.10 MPa

Nominal Sizes Selection Chart

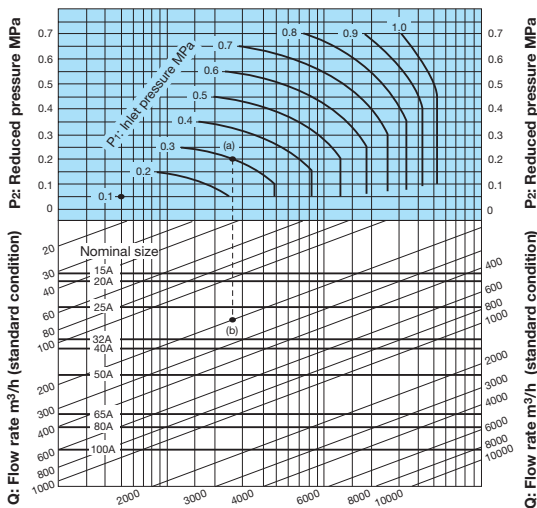
**[Example]**

When selecting the nominal size of a pressure reducing valve whose inlet pressure (P_1), reduced pressure (P_2), and flow rate are 0.3 MPa, 0.2 MPa, and 200 m^3/h (standard condition), respectively, first find intersection point (a) of the inlet pressure (P_1) of 0.3 MPa and the reduced pressure (P_2) of 0.2 MPa. Trace down vertically from this intersection point to find intersection point (b) with the flow rate of 200 m^3/h (standard condition). Since intersection point (b) lies between nominal sizes 25A and 32A, select the larger one, 32A.

* Set the safety factor at 80 to 90%.

GP-1000T

Direct type	Pilot type	Piston	Diaphragm
Bellows	Internal sensing	External sensing	Stainless steel
With handle	Built-in strainer	Low pressure	Remote
Valve leakage 0	Nylon		



GP-1000T



GP-1010T



GP-1200T

■Features

1. Far superior to conventional pressure reducing valve in workability and durability.
2. Free of valve seat leakage. Improved workability as a result of refinement of sliding parts.
3. Simple and robust internal structure.

■Specifications

Model	GP-1000T	GP-1010T	GP-1200T	GP-1210T
Application	Air, Other non-dangerous fluids			
Inlet pressure	0.1-1.0 MPa			
Reduced pressure	0.05-0.9 MPa			
	90% or less of inlet pressure (gauge pressure)			
Minimum differential pressure	0.05 MPa			
Maximum pressure reduction ratio	20:1			
Application temperature	5-80°C			
Valve seat leakage	None			
Material	Body	Ductile cast iron		
	Valve	Brass (NBR incorporated)		
	Valve seat	Stainless steel		
	Piston, cylinder	Brass or bronze		
	Diaphragm	Stainless steel		
Connection	JIS 10K FF flanged	JIS Rc screwed	JIS 10K FF flanged	JIS Rc screwed

· Available with stainless steel made trim parts (piston, cylinder and valve) as GP-□□□□TS.

GP-1000TSS, 1000TAS

- Direct type Pilot type Piston Diaphragm
- Bellows Internal sensing External sensing **Stainless steel**
- With handle Built-in strainer Low pressure Remote
- Valve leakage 0 Nylon

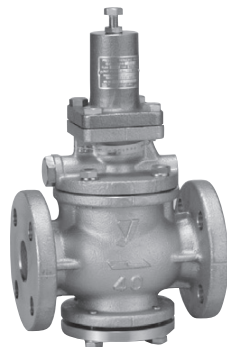

GP-1000TAS

■Features

1. Stainless steel is used for wetted parts (GP-1000TSS) and all parts (GP-1000TAS), improving corrosion resistance.
2. Free of valve seat leakage. Improved workability as a result of refinement of sliding parts.
3. Simple and robust internal structure.

■Specifications

Stainless steel wetted parts

All stainless steel

Model	GP-1000TSS	GP-1000TAS
Application	Air, Other non-dangerous fluids	
Inlet pressure	0.1-1.0 MPa	
Reduced pressure	0.05-0.9 MPa	
Adjusted reduced pressure	90% or less of inlet pressure (gauge pressure)	
Minimum differential pressure	0.05 MPa	
Maximum pressure reduction ratio	20:1	
Application temperature	5-80°C	
Valve seat leakage	None	
Material	Body	Cast stainless steel
	Valve	Stainless steel (NBR contained)
	Valve seat	Stainless steel
	Piston, cylinder	Stainless steel
	Diaphragm	Stainless steel
Connection	JIS 10K FF flanged	

Description of GP-1000T Series model code

GP-1000T□

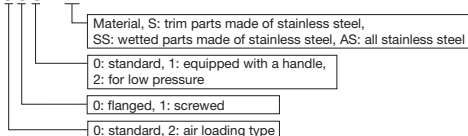

■ Dimensions (mm) and Weights (kg)

• GP-1000T · 1200T

Nominal size	L	H ₁	H	Weight
15A	150	64	285 (220)	8.0
20A	155	64	285 (220)	8.5
25A	160	67	300 (235)	10.0
32A	190	82	323 (258)	14.0
40A	190	82	323 (258)	14.5
50A	220	93	347 (282)	20.0
65A	245	100	357 (292)	30.0
80A	290	122	404 (339)	35.0
100A	330	144	450 (385)	52.5

* The above values in parentheses are the dimensions of the GP-1200T.

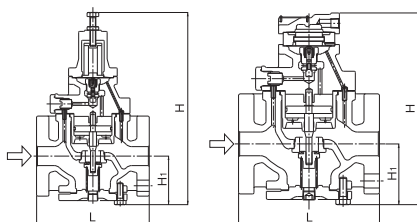

GP-1000T

GP-1200T

• GP-1010T · 1210T

Nominal size	d	L	H ₁	H	Weight
15A	Rc 1/2	150	64	285 (220)	7.0
20A	Rc 3/4	155	64	285 (220)	7.0
25A	Rc 1	160	67	300 (235)	8.5
32A	Rc 1-1/4	190	82	323 (258)	12.0
40A	Rc 1-1/2	190	82	323 (258)	12.5
50A	Rc 2	220	93	347 (282)	18.0

* The above values in parentheses are the dimensions of the GP-1210T.

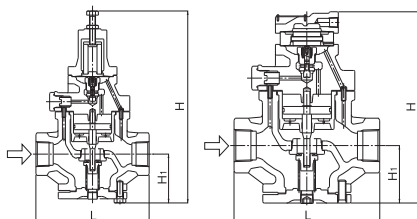

GP-1010T

GP-1210T

• GP-1000TSS · 1000TAS

Nominal size	L	H ₁	H	Weight
15A	150	67	288 (298)	8.3 (8.5)
20A	155	67	288 (298)	8.8 (9.0)
25A	160	70	303 (313)	10.5 (10.7)
32A	190	85	326 (336)	14.8 (15.0)
40A	190	85	326 (336)	15.3 (15.5)
50A	220	96	350 (360)	20.8 (21.0)

* The above values in parentheses are the dimensions and weights of the GP-1000TAS.

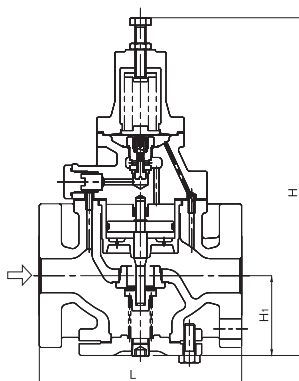
GP-1000TSS
GP-1000TAS

■ Loading Air Pressure-set Pressure Chart

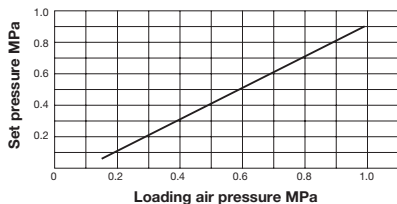

Basically, the set pressure to the loading air pressure is as shown in the chart on the left. The set pressure is slightly different depending on the conditions. In this case, adjust the loading air pressure.

■ Specifications Selection Chart

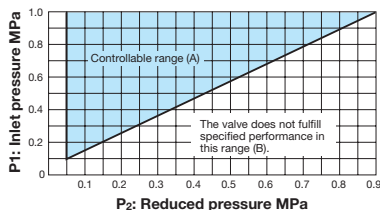

Find the intersection point of the inlet and reduced pressures. If the intersection point is within range (A), the pressures are controllable. The valve does not fulfill specified performance if the intersection point lies in range (B).

■ Table of Corrected Cv Values

Please refer to ■-14 for Cv value.

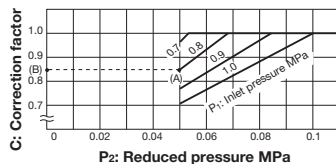

If the inlet pressure exceeds 0.7 MPa, and the pressure reducing ratio exceeds 10:1, find the appropriate correction coefficient C using chart above, and multiply the rated Cv value, and obtain the corrected Cv value.

Example

Take a pressure reducing valve whose inlet pressure is 0.8 MPa, the reduced pressure is 0.05 MPa. Find the inlet and reduced pressure intersection point (A) at the above chart, then draw a horizontal line in the leftward direction to point (B) which indicates a correction coefficient of 0.85. For a nominal size of 25A, the corrected Cv value would be calculated as follows:
 $4 \text{ (rated Cv value)} \times 0.85 \text{ (correction coefficient)} = 3.4$

■ GP-1000T Series Selection Chart

■ Flow Characteristic Chart

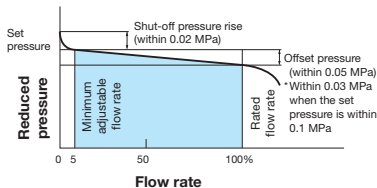

■ Pressure Characteristic Chart

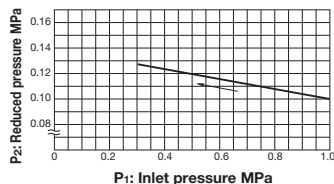

This chart shows variation in reduced pressure when the inlet pressure of 1.0 MPa is changed between 0.3 MPa and 1.0 MPa while the reduced pressure is set at 0.1 MPa.

Nominal Sizes Selection Chart (Fluid: 20°C Air)

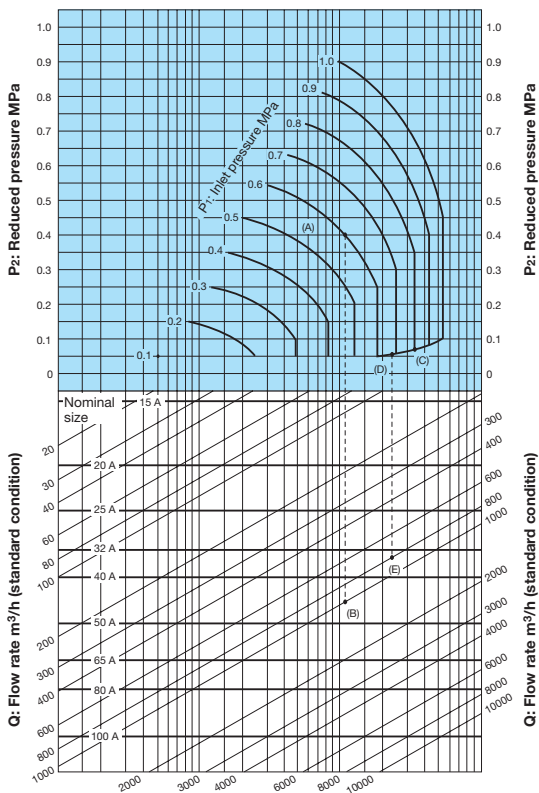

[Example 1]

When selecting the nominal size of a pressure reducing valve whose inlet pressure (P_1), reduced pressure (P_2), and air flow rate are 0.6 MPa, 0.4 MPa, and 1,000 m^3/h (standard condition), respectively, first find intersection point (A) of the inlet pressure of 0.6 MPa and the reduced pressure of 0.4 MPa. Trace down vertically from this intersection point to find intersection point (B) with the flow rate of 1,000 m^3/h (standard condition). Since intersection point (B) lies between nominal sizes 40A and 50A, select the larger one, 50A.

[Example 2]

When selecting the nominal size of a pressure reducing valve whose inlet pressure (P_1), reduced pressure (P_2), and air flow rate are 0.8 MPa, 0.05 MPa, and 800 m^3/h (standard condition), respectively, first find intersection point (C) of the inlet pressure of 0.8 MPa and the diagonal line. Trace down to the left from the diagonal line to find intersection point (D) with the reduced pressure of 0.05 MPa. Trace down vertically from intersection point (D) to find intersection point (E) with the flow rate of 800 m^3/h (standard condition). Since intersection point (E) lies between nominal sizes 32A and 40A, select the larger one, 40A.

* Set the safety factor at 80 to 90%.

GD-400,400SS

Direct type	Pilot type	Piston	Diaphragm
Bellows	Internal sensing	External sensing	Stainless steel
With handle	Built-in strainer	Slight pressure	Remote
Valve leakage 0	Nylon		



GD-400SS

■Features

1. Pressure balance structure can keep the reduced pressure at a constant level without being affected by inlet pressure.
2. Due to simple structure, disassembly and maintenance can be conducted easily.
3. Wide range of use due to high maximum pressure ratio.
4. Diaphragm with a large pressure sensing area has accuracy to high set pressure.

■Specifications

Model		GD-400	GD-400SS
Nominal size		15-50A	
Application		Air, Nitrogen gas *1	
Inlet pressure		2.5-400 kPa	
Reduced pressure		(A) 0.5-1.4 kPa (B) 1.2-3.3 kPa (C) 3.0-8.0 kPa (D) 7.0-20 kPa	
Working temperature		5-60°C	
Minimum differential pressure		2.0 kPa	
Maximum pressure reduction ratio		400:1	
Reduced pressure detection method		External sensing *2	
Minimum adjustable flow rate		15-25A: 1.2 m ³ /h (standard condition) 32-50A: 10.0 m ³ /h (standard condition)	
Material	Body	Cast iron	Cast stainless steel (SCS14)
	Valve	Stainless steel	
	Valves seat	Stainless steel	
	Disc	NBR *3	
	Spindle	Stainless steel	
	Diaphragm	NBR *3	
Connection		JIS 10K FF Flanged	

*1 Please contact us when using for other fluids.

*2 A conduit (ϕ 8-2 m) and a joint for external sensing are included for GD-400.

*3 Available with FKM type.

■Dimensions (mm) and Weights (kg)

Nominal size	L	H ₁	H	Weight
15A	166	86	526	29.0 (32.0)
20A	170	86	526	29.0 (32.0)
25A	170	86	526	30.0 (33.0)
32A	180	96	561	32.0 (34.0)
40A	180	96	561	32.0 (34.0)
50A	180	101	561	33.0 (35.0)

* The values in parentheses are the weights of the GD-400SS.

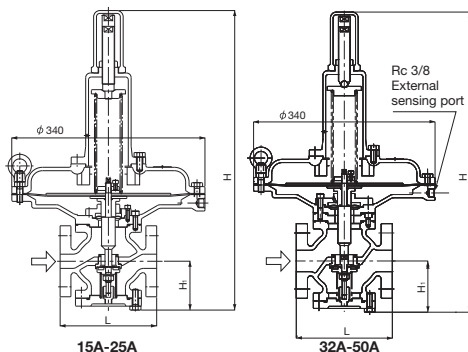

Flow Characteristic Chart

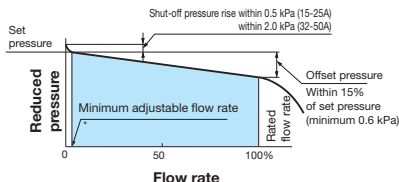

- * 15-25A: 1.2 m³/h (standard condition)
32-50A: 10.0 m³/h (standard condition)

Pressure Characteristic Chart

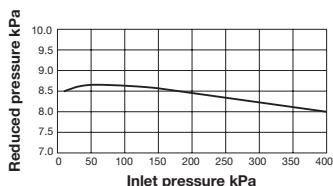

This chart shows variation in reduced pressure when the inlet pressure of 400 kPa is changed to 10 kPa while the reduced pressure is set at 8.0 kPa.

Specifications Chart

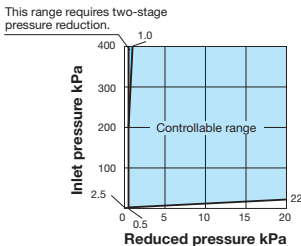

■Piping Diagram Example

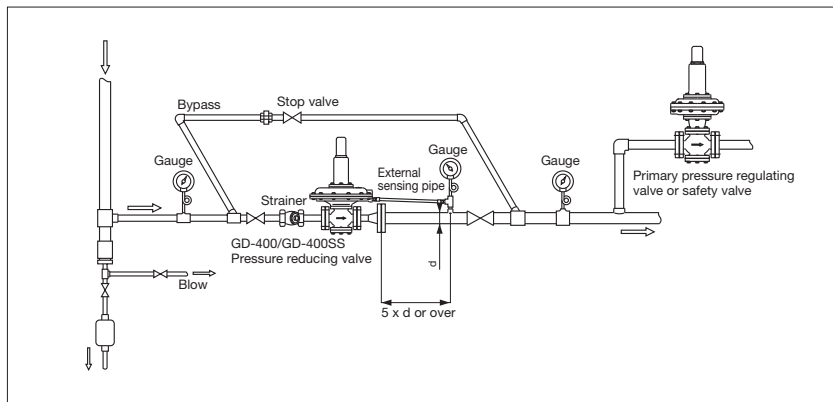

[Precautions]

1. Connect the external sensing part to the outlet side.
2. Do not adjust needle valve of the pressure reducing valve unreasonably.
3. Make sure to use a pipe with a diameter that can keep the inside flow velocity between 5 m/s and 15 m/s for outlet side.
4. When performing pressure test or airtight test after connected to the piping, apply the airtight pressure specified in the right table.

* If pressure beyond the specified airtight pressure is applied, internal parts may be damaged.

				Airtight test pressure	
				Inlet pressure	
Airtight test	Reduced pressure	Spring range	A	1.8 kPa or less	
			B	4.2 kPa or less	
			C	10 kPa or less	
			D	25 kPa or less	

■ Chart for Selecting Nominal Sizes (GD-400)

When the inlet pressure is between 2.5 kPa and 200 kPa (Fluid: 20°C Air)

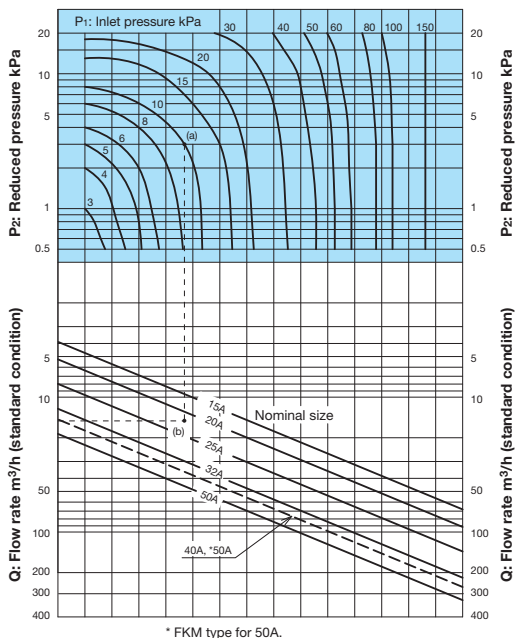

[Example]

When selecting the nominal size of a pressure reducing valve whose inlet pressure (P_1), reduced pressure (P_2), and flow rate are 10 kPa, 3 kPa, and 15 m³/h (standard condition), respectively, first find intersection point (a) of the inlet pressure of 10 kPa and the reduced pressure of 3 kPa. Trace down vertically from this intersection point to find intersection point (b) with the flow rate of 15 m³/h (standard condition). Since intersection point (b) lies between nominal sizes 20A and 25A, select the larger one, 25A.

* Set the safety factor at 80 to 90%.

Table 1: When the inlet pressure is between 200 kPa and 400 kPa

Nominal size	Inlet pressure (kPa)	Rated flow rate (m ³ /h [standard condition])	
		Reduced pressure (kPa)	
		0.5-4	4-20
15A	200-400	60	60
20A	200-300	90	90
	300-400	90	120
25A	200-300	120	120
	300-400	120	150
	400	120	190

Nominal size	Inlet pressure (kPa)	Rated flow rate (m ³ /h [standard condition])	
		Reduced pressure (kPa)	
		0.5-4	4-20
32A	200-400	200	250
	300-400	200	300
40A	200-300	250	300
	300-400	250	350
50A	200-300	350 [300]	400 [350]
	300-400	350 [300]	450 [400]

* The values in parentheses are the rate of FKM type.

Chart for Selecting Nominal Sizes (GD-400SS)

When the inlet pressure is between 2.5 kPa and 200 kPa (Fluid: 20°C Air)

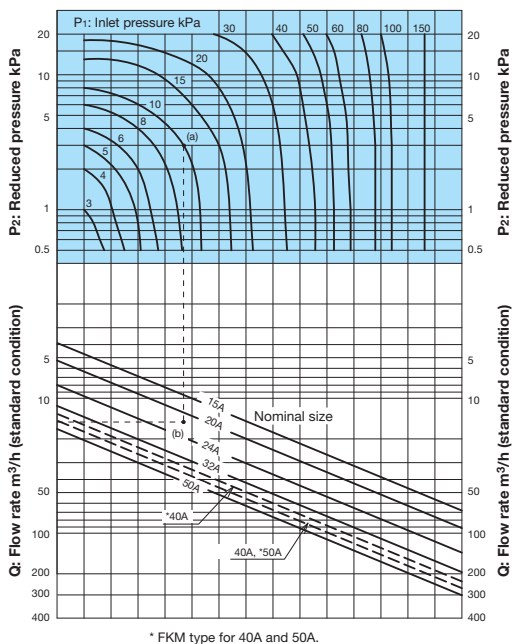

[Example]

When selecting the nominal size of a pressure reducing valve whose inlet pressure (P_1), reduced pressure (P_2), and flow rate are 10 kPa, 3 kPa, and 15 m^3/h (standard condition), respectively, first find intersection point (a) of the inlet pressure of 10 kPa and the reduced pressure of 3 kPa. Trace down vertically from this intersection point to find intersection point (b) with the flow rate of 15 m^3/h (standard condition). Since intersection point (b) lies between nominal sizes 20A and 25A, select the larger one, 25A.

* Set the safety factor at 80 to 90%.

Table 1: When the inlet pressure is between 200 kPa and 400 kPa

Nominal size	Inlet pressure (kPa)	Rated flow rate (m^3/h [standard condition])	
		Reduced pressure (kPa)	
		0.5-4	4-20
15A	200-400	60	60
20A	200-300	90	90
	300-400	90	120
25A	200-300	120	120
	300-400	120	150
	400	120	190

Nominal size	Inlet pressure (kPa)	Rated flow rate (m^3/h [standard condition])	
		Reduced pressure (kPa)	
		0.5-4	4-20
32A	200-300	200	250
	300-400	200	300
40A	200-300	250	275
	300-400	250	325
50A	200-300	325 [275]	375 [325]
	300-400	325 [275]	425 [375]

* The values in parentheses are the rate of FKM type.

GD-4

Direct type	Pilot type	Piston	Diaphragm
Bellows	Internal sensing	External sensing	Stainless steel
With handle	Built-in strainer	Slight pressure	Remote
Valve leakage 0	Nylon		

■Features

1. Diaphragm with a large pressure sensing area has high accuracy to set pressure.
2. No outside leakage since there is no gland part.



■Specifications

Application	Air, Other non-dangerous fluids					
Nominal size	15-50A			65-150A		
Diaphragm diameter (mm)	φ 400	φ 340	φ 256	φ 400	φ 340	φ 256
Inlet pressure	300 kPa					
Reduced pressure (kPa)	2-5	5-10	10-25	2-4	10-20	20-50
			25-50	4-6		50-100
			50-100	6-10		100-200
			100-200			100-200
Adjusted reduced pressure	70% or less of inlet pressure (gauge pressure)					
Minimum differential pressure	1 kPa	2 kPa	3 kPa	1 kPa	2 kPa	3 kPa
Maximum pressure reduction ratio	7:1			10:1		
Application temperature	5-80°C					
Valve seat leakage	No leakage for 15A-50A. 0.5% or less of rated flow rate for 65A-150A.					
Material	Body	Cast iron *1				
	Valve	NBR		Stainless steel		
	Valve seat, Spindle	Stainless steel				
	Diaphragm	NBR				
Connection	JIS 10K FF flanged					

*1 Available with carbon steel or stainless steel body for 20A to 150A.

■ Dimensions (mm) and Weights (kg)

Nominal size	L	H		H ₁	Weight
		H _a	H _b		
15A	166	565	580	90	27
20A	170	565	580	90	27
25A	170	565	580	90	28
32A	180	585	600	100	28
40A	180	585	600	100	29
50A	180	595	610	105	31
65A	215	700	715	125	39
80A	260	715	730	135	48
100A	300	785	800	160	64
120A	360	840	855	190	88
150A	382	895	910	220	123

Note) Dimension H will be different depends on diaphragm diameter. (H_a: ϕ 256 H_b: ϕ 340, ϕ 400)

Note) The value of product weights are when diaphragm diameter is ϕ 256. Please add 5kg for ϕ 340, and 9kg for ϕ 400.

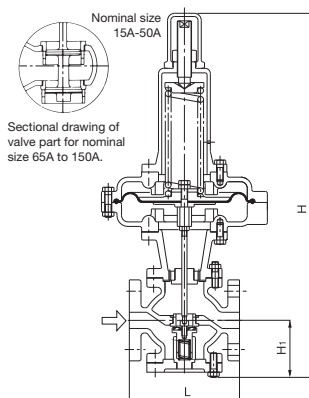

Structure will be different depends on nominal size and diaphragm diameter.

GD-4 Specifications Selection Chart

Nominal size 15A-50A

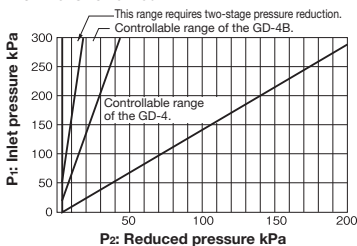

Nominal size 65A-150A

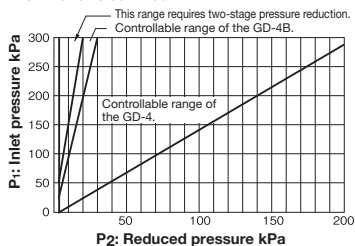

Flow Characteristic Chart

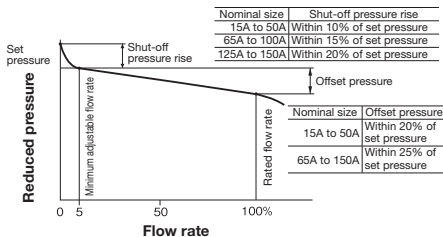

Pressure Characteristic Chart

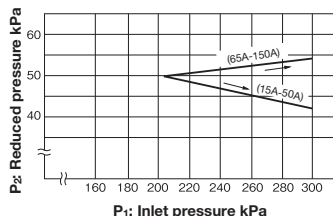

This chart shows variation in reduced pressure when the inlet pressure of 200 kPa is changed to 300 kPa while the reduced pressure is set at 50 kPa.

Nominal Size Selection Chart (For Air)

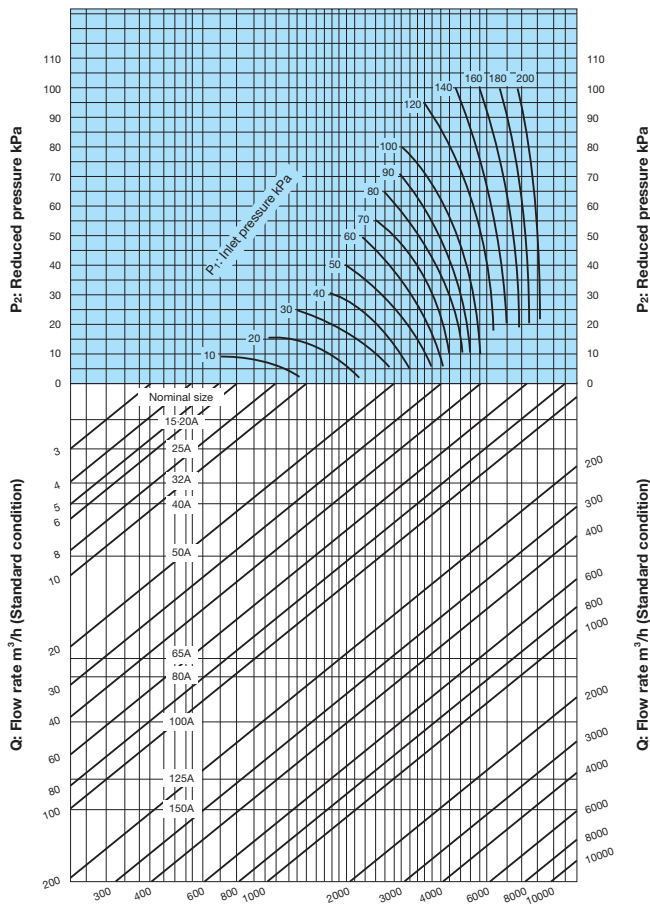

* Set the safety factor at 80 to 90%.

GD-4B

Direct type	Pilot type	Piston	Diaphragm
Bellows	Internal sensing	External sensing	Stainless steel
With handle	Built-in strainer	Slight pressure	Remote
Valve leakage 0	Nylon		



■Features

1. Diaphragm with a large pressure sensing area has accuracy to high set pressure.
2. No outside leakage since there is no gland part.
3. Adopts pressure balance structure.

■Specifications

Application	Air, Other non-dangerous fluids					
Nominal size	15-50A			65-150A		
Diaphragm diameter (mm)	φ 400	φ 340	φ 256	φ 400	φ 340	φ 256
Inlet pressure	800 kPa			500 kPa		
Reduced pressure (kPa)	2-5	5-10	10-25	2-4	10-20	20-50
			25-50	4-6		50-100
			50-100	6-10		100-200
			100-200			100-200
Adjusted reduced pressure	85% or less of inlet pressure (gauge pressure)					
Minimum differential pressure	1 kPa	2 kPa	3 kPa	1 kPa	2 kPa	3 kPa
Maximum pressure reduction ratio	20:1			15:1		
Application temperature	5-80°C					
Valve seat leakage	No leakage					
Material	Body	Cast iron *1				
	Valve	NBR				
	Valve seat, Spindle	Stainless steel				
	Diaphragm	NBR				
Connection	JIS 10K FF flanged					

*1 Available with carbon steel or stainless steel body for 20A to 150A.

■ Dimensions (mm) and Weights (kg)

Nominal size	L	H		H ₁	Weight
		Ha	Hb		
15A	166	575	590	95	27
20A	170	575	590	95	27
25A	170	575	590	95	28
32A	180	585	600	100	28
40A	180	585	600	100	29
50A	180	605	620	110	31
65A	215	700	715	125	39
80A	260	715	730	140	48
100A	300	785	800	165	64
120A	360	840	855	195	88
150A	382	895	910	225	123

Note) Dimension H will be different depends on diaphragm diameter. (Ha: φ256 Hb: φ340, φ400)

Note) The value of product weights are when diaphragm diameter is φ256. Please add 5kg for φ340, and 9kg for φ400.

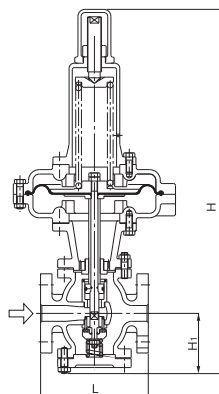

Structure will be different depends on nominal size and diaphragm diameter.

GD-4B Specifications Selection Chart

· Nominal size 15A-50A

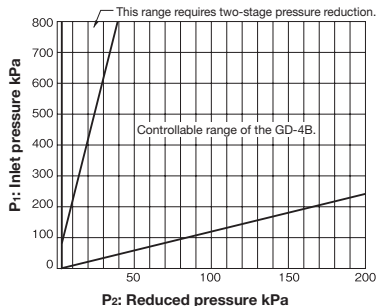

· Nominal size 65A-150A

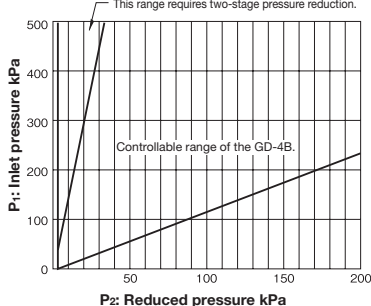

Flow Characteristic Chart

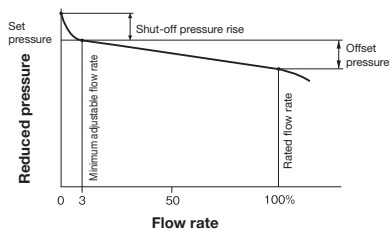

Nominal size	Shut-off pressure rise
15A-50A	Within 10% of set pressure
65A-100A	Within 15% of set pressure
125A-150A	Within 20% of set pressure

Nominal size	Offset pressure
15A-50A	Within 20% of set pressure
65A-150A	Within 25% of set pressure

GD-4B Nominal Size Selection Chart (For Air)

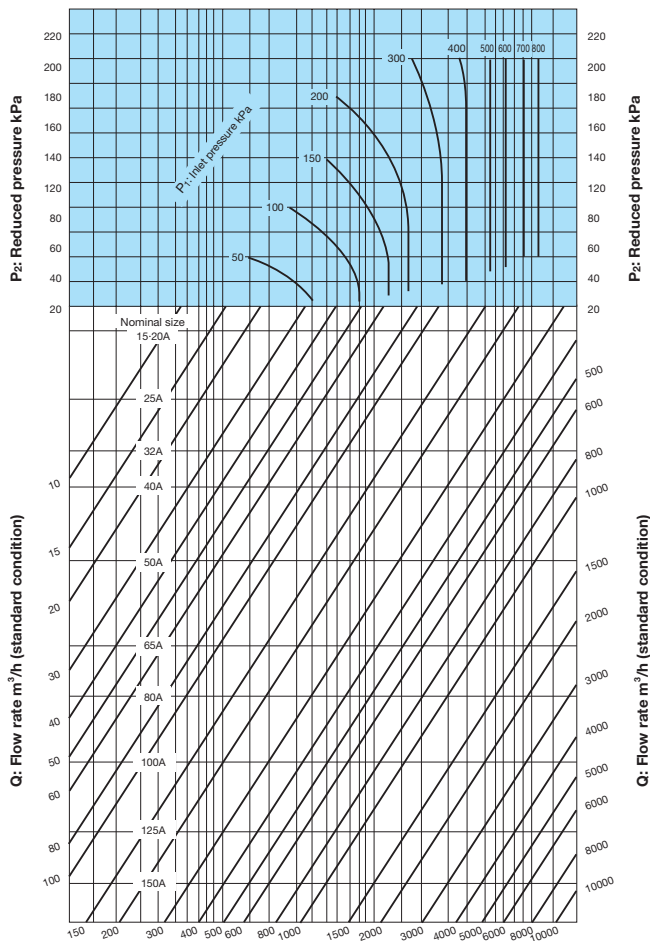

* Set the safety factor at 80 to 90%.

GD-9N

Direct type	Pilot type	Piston	Diaphragm
Bellows	Internal sensing	External sensing	Stainless steel
With handle	Built-in strainer	Low pressure	Remote
Valve leakage 0	Nylon		



GD-9N

■Features

1. Compact and lightweight.
2. Easy to adjust wide pressure range by handle.
3. Able to install pressure gauge for sensing the outlet pressure.

■Specifications

Model		GD-9N	
Nominal size	25A	8A, 10A, 15A, 20A	
Application	Air, Other non-dangerous fluids		
Inlet pressure	0.1-1.0 MPa		
Reduced pressure	0.05-0.85 MPa	0.05-0.7 MPa	
Application temperature	5-60°C		
Material	Body	Aluminum die casting	
	Valve	NBR	
	Valve seat	Brass	
	Diaphragm	NBR	
Relief pressure	Set pressure + 0.05 MPa		
Connection	JIS Rc screwed		
Structure	Relief type		
Valve seat leakage	No leakage		

- The product cannot be used for toxic and flammable gases.
 - Available with dedicated brackets.
 - Available with 6 types pressure gauge.
- 8A, 10A- Outer diameter ϕ 37.5-Max. 1.0 MPa or 0.4 MPa or 0.2 MPa
 15A, 20A, 25A- Outer diameter ϕ 42.5-Max. 1.0 MPa or 0.4 MPa or 0.2 MPa

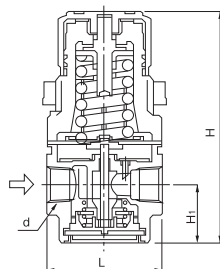

GD-9N

■Dimensions (mm) and Weights (kg)

Nominal size	d	L	H	H ₁	Pressure gauge connection port	Weight
8A	Rc 1/4	53	93.9	23.5	Rc 1/8	0.19
10A	Rc 3/8	53	110.5	27	Rc 1/8	0.34
15A	Rc 1/2	70	133.5	33.5	Rc 1/8	0.58
20A	Rc 3/4	75	135	33.5	Rc 1/8	0.6
25A	Rc 1	95	175.6	46	Rc 1/8	1.22

Flow Characteristic Chart for each Nominal Sizes [Air: Inlet pressure 0.7MPa]

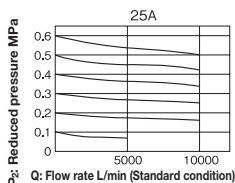
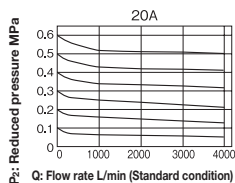
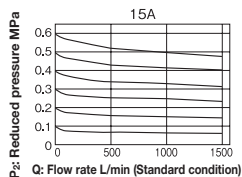
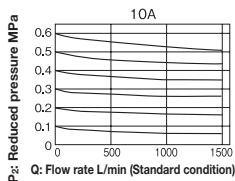
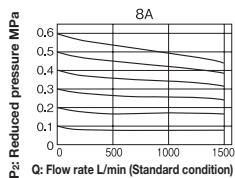

* No constraint in minimum adjustable flow rate.

Pressure Characteristic Chart for each Nominal Sizes [Air: Inlet pressure 0.7MPa, Reduced pressure 0.2MPa, Flow rate 20L/min (Standard condition)]

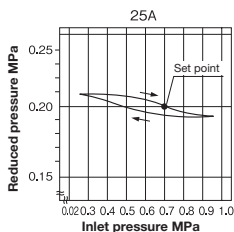
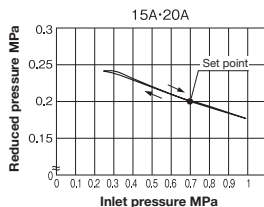
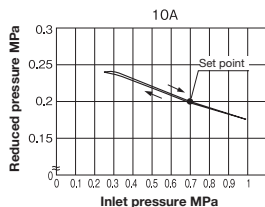
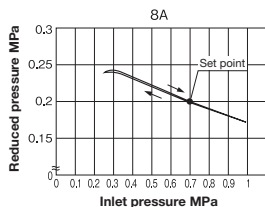

Pressure Reducing Valve – Annex

- GP-2000 Disassembly and troubleshooting **1**-118
- GP-1000 Disassembly and troubleshooting **1**-120
- GP-27 Disassembly and troubleshooting **1**-122
- Troubleshooting for other models **1**-124

CAUTION Please refer to the manual attached to the product for procedures for installation and operation.

Disassembly and troubleshooting

GP-2000 Pressure Reducing Valve

- Most of troubles at a pressure reducing valve is caused by foreign substances and scales in the piping. Be careful sufficiently.
- Phenomenon like valve trouble happens by strainer clogging, pressure gauge failure, by-pass valve leakage, or leaving by-pass valve open. Please check these conditions first, and then take a proper remedy for the pressure reducing valve.
- * Please contact us for disassembly and troubleshooting of GPK, GDK series.

GP-2000

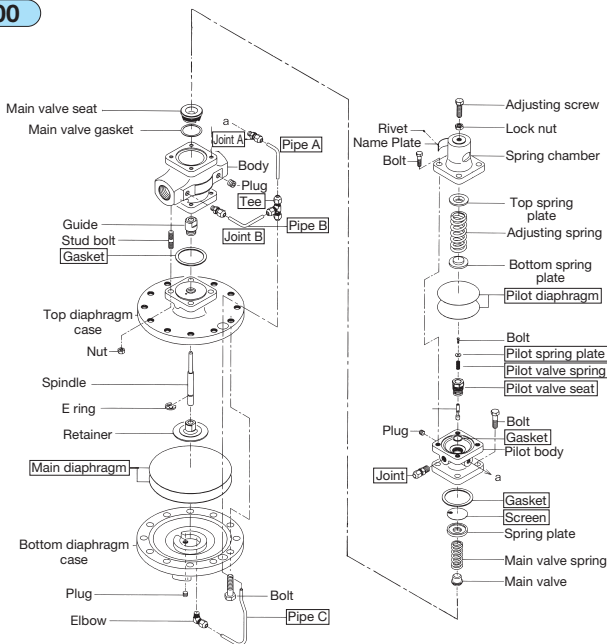

Note) The parts shown in the rectangle boxes are available as consumable supply.

· Disassembly of pilot valve

1. Slightly loosen the lock nut and turn the adjusting screw counterclockwise to release the adjusting spring force (no compression).
2. Remove the bolt of the spring chamber. Detach the spring chamber, spring, top spring plate, bottom spring plate, and pilot diaphragm.
3. Detach the pilot valve seat (hexagonal section of the center of pilot body) using a ring spanner or a socket wrench (nominal size 22), and take out the entire pilot valve assembly.

· Disassembly of main valve

1. Detach the pipe A at the joint A or tee.
2. For nominal sizes 15A to 40A, remove the bolt of the pilot body. Detach the spring plate, screen, main valve spring, and main valve. For nominal sizes 50A to 100A, detach the bolt of the spacer and detach the spacer from the main body, main valve spring, and entire main valve (for nominal size 50A, main valve spring and main valve).
3. A dedicated tool is required to detach the valve seat.

· Main diaphragm

1. Detach the pipe C at the tee.
2. Remove the bolt of the bottom diaphragm case. Detach the bottom diaphragm case, main diaphragm, retainer, and spindle. (For nominal sizes 65A to 100A, detach adapter and retainer.)

· Precautions during reassembly

1. Check that there is no damage and scratches on the main valve, main valve seat, pilot valve, and pilot valve seat. Any damage or scratches at the sealing surface lead to leakage.
2. Move the sliding section (pilot valve, piston, etc.) two to three times and check that they move smoothly.
3. Make sure that the retainer and spindle are properly assembled.
4. Replace the gaskets with new ones when reassembling.

* Please refer to the manual attached to the product for detailed information.



Completely discharge the internal pressure from the valves before disassembly.

CAUTION Please refer to the manual attached to the product for procedures for installation and operation.

Trouble	Cause	Remedy
Reduced pressure does not reach the desired value.	• Working pressure is improper.	Correct the working pressure. Reduced pressure should be 85% or less of inlet pressure. (Gauge pressure.)
	• Screen is clogged.	Disassemble and clean.
	• Main diaphragm is damaged.	Dismount elbow, and open by-pass valve. If fluid runs out from elbow, replace the main diaphragm.
	• Orifice of tee is clogged.	Disassemble and clean.
	• Pilot valve and/or pilot valve seat are clogged. ...	Disassemble and clean pilot valve assembly.
	• Sensing pipe is clogged.	Disassemble and clean.
	• Nominal size of the product is too small for the specifications of the system.	Replace the product with one of proper nominal size.
	• Tee is set wrong.	Set correctly.
	• Strainer installed before pressure reducing valve ...	Disassemble and clean.
	• is clogged.	
• Trouble with pressure gauge.	Replace the gauge.	
Reduced pressure exceeds the set pressure.	• Foreign substances are stuck between main valve and main valve seat, or either of the parts is damaged.	Release adjusting spring, remove joint A, and supply fluid at the inlet. If the fluid runs out from tee, clean main valve and main valve seat. Lap the parts if scratches are found.
	• Foreign substances are stuck between pilot valve and pilot valve seat, or either of the parts is damaged.	Supply fluid by the same procedures above. If the fluid runs out from pilot body, replace pilot valve assembly.
	• Orifice of tee is clogged.	Detach tee and clean it.
	• Pressure adjustment is improper.	Readjust the set pressure according to instructions.
	• Trap is not provided on a dead-end line.	Install a trap.
	• By-pass stop valve leaks.	Repair or replace the by-pass stop valve.
Abnormal sound, Unstable operation	• The orifice at joint B is partially clogged.	Detach joint B and clean.
	• Flow at pressure sensing point is excessively unstable.	Change the sensing point to make it with stable flow.
	• Condensate flows into sensing pipe.	Make the valve higher than the pressure sensing point.
	• Nominal size is too large for the specifications. ...	Replace the product with one of proper nominal size
	• Outlet pipe diameter is too small.	Select a pipe size so that flow velocity can be 30 m/s or less.

Adjustment procedures

Incorrect adjustment may cause hunting, scale problems or water hammer, and may heavily damage the main parts of the product. Be sure to follow the steps below.

1. Be sure to close all the stop valves.
2. Open the stop valve for the trap installed before the pressure reducing valve.
3. Slowly open the inlet stop valve and adjust the valve travel of the by-pass stop valve and adjust its opening so as not to blow the safety valve. Then completely discharge foreign substances by allowing fluid pass through the by-pass line. After discharging, be sure to close the by-pass stop valve.
4. Loosen the lock nut and turn the adjusting screw counterclockwise to release the spring force (no compression).
5. Open the sensing pipe stop valve, and the stop valve at the outlet side of the pressure reducing valve. Adjust the travel of the stop valve so that a little fluid flows.
6. After confirming that condensate is discharged from the trap before the pressure reducing valve, slowly open the inlet stop valve.
7. Slowly turn the adjusting screw to achieve the desired pressure (clockwise to increase, counterclockwise to reduce) while observing the pressure gauge at the outlet side.
8. Slowly open the outlet stop valve and readjust the adjusting screw to achieve the desired pressure at the outlet side.
9. After adjustment, tighten the lock nut.

Parts Kit

GP-2000 Pressure reducing valve

Kit name	Contents
Main valve kit	Main valve, Main valve spring, Gasket (for top of body), Gasket (for bottom of body, only 50A to 125A), Spacer gasket
Pilot valve kit	Pilot valve assembly (pilot valve, pilot valve seat, pilot valve spring, pilot spring plate, bolts), Pilot diaphragm
Gasket kit	Screen, Gasket (for top of body), Gasket (for pilot valve), Gasket (for bottom of body, only 50A to 125A), Spacer gasket
Tube kit	Joint A, Joint B, Elbow, tee, Pipe A, Pipe B, Pipe C



Completely discharge the internal pressure from the valves before disassembly.

CAUTION Please refer to the manual attached to the product for procedures for installation and operation.

Disassembly and troubleshooting

Pressure Reducing Valve

GP-1000

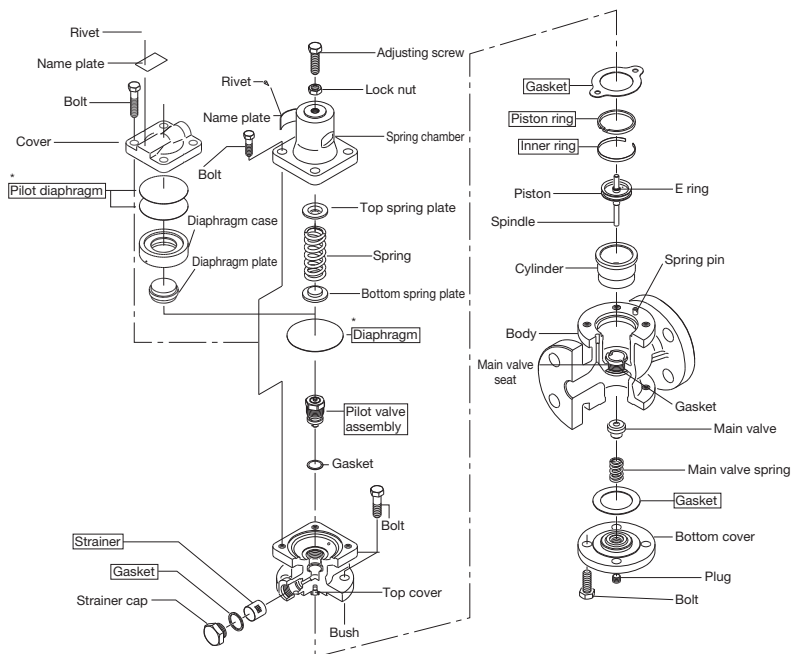

GP-1002 has two diaphragms and two piston rings.

Note) The parts shown in the rectangle boxes are available as consumable supply.

• Disassembly of pilot valve

1. Loosen the lock nut and turn the adjusting screw to release the adjusting spring (no compression).
2. Detach the bolt and the spring chamber. Then detach the adjusting spring, top spring plate, bottom spring plate, and diaphragm. (For GP-1200 series, remove the bolt and the cover, and then detach the pilot diaphragm, diaphragm case, diaphragm plate, and diaphragm.)
3. Detach the pilot valve assembly using a ring spanner or a socket wrench (nominal size 22).

• Disassembly of strainer

1. Loosen the strainer cap by using a ring spanner or a socket wrench (nominal size 27), and remove the strainer.

• Disassembly of piston

1. Remove the bolt and the top cover, and then detach the spindle. Detach the piston ring and the inner ring.

• Disassembly of main valve

1. Remove the bolt, and then detach the bottom cover, main valve spring, and main valve.

• Precautions during reassembly

1. Check that there is no damage and scratches on the main valve, main valve seat, pilot valve, and pilot valve seat.
2. Move the sliding section (pilot valve, piston, etc.) two to three times and check that they move smoothly.
3. Replace the gaskets with new ones when reassembling.
4. Reassemble in the reverse order from disassembly. Tighten the bolts evenly in the diagonal order.



Completely discharge the internal pressure from the valves before disassembly.

CAUTION Please refer to the manual attached to the product for procedures for installation and operation.

Trouble	Cause	Remedy
Reduced pressure does not reach the desired value.	• Working pressure is improper.	Correct the working pressure. (Please refer to Specification selection chart.)
	• Strainer is clogged.	Disassemble and clean.
	• Foreign substances are stuck between piston and cylinder.	Disassemble and remove the foreign substances. Finish with sandpaper if scratches are found.
	• Piston ring is damaged.	Replace piston ring.
	• Nominal size of the product is too small for the specifications of the system.	Replace the product with one of proper nominal size. (Please refer to Nominal size selection chart.)
	• Pressure adjustment is improper.	Readjust the set pressure according to instructions.
Reduced pressure exceeds the set pressure.	• Strainer at the inlet is clogged.	Disassemble and clean.
	• Trouble with pressure gauge.	Replace the gauge.
	• Foreign substances are stuck between main valve and main valve seat, or either of the parts is damaged.	Disassemble and remove the foreign substances. Lap the parts if scratches are found.
	• Foreign substances are stuck between pilot valve and pilot valve seat, or either of the parts is damaged.	Disassemble and remove the foreign substances. Finish with sandpaper if scratches are found.
	• Foreign substances are stuck between piston and cylinder.	Disassemble and remove the foreign substances. Finish with sandpaper if scratches are found.
	• Trap is not provided on a dead-end line.	Install a trap.
Abnormal sound.	• By-pass stop valve leaks.	Repair or replace the by-pass stop valve.
	• Diaphragm is damaged.	Replace the diaphragm.
	• Nominal size is too large for the specifications.	Replace the product with one of proper nominal size
	• Too much high pressure reduction ratio.	Reduce the pressure in two stages.
Outside leakage	• Condensate-induced trouble.	Install a trap.
	• A quick operating valve is installed near the product.	Take as large distance as possible from the on-off valve.
	• Outlet pipe diameter is too small.	Select a pipe size so that flow velocity can be 30 m/s or less.
	• Gasket on body is deteriorated or damaged.	Replace the gasket.
	• Diaphragm is damaged.	Replace the diaphragm.

Adjustment procedures

Incorrect adjustment may cause hunting, scale problems or water hammer, and may heavily damage the main parts of the product. Be sure to follow the steps below.

1. Be sure to close all the stop valves. Slowly open the inlet stop valve and adjust the valve travel of the by-pass stop valve and adjust its opening so as not to blow the safety valve. Then completely discharge foreign substances by allowing fluid pass through the by-pass line. After discharging, be sure to close the by-pass stop valve.
2. Slowly open the inlet stop valve and adjust the travel of the outlet stop valve so that a little fluid flows.
3. Loosen the lock nut, and slowly turn the adjusting screw

to achieve the desired pressure (clockwise to increase, counterclockwise to reduce) while observing the pressure gauge of the outlet. For the model with a handle, the handle is locked in normal position, so push down and turn the handle slowly to adjust the reduced pressure (clockwise to increase, counterclockwise to reduce) while observing the pressure gauge at the outlet side.

4. Slowly open the outlet stop valve and readjust the adjusting screw/handle to achieve the desired pressure at the outlet side.
5. After adjustment, tighten the lock nut. For the model with a handle, release the hold and then the handle is pulled up and locked. If it is not locked, slide it to left and right then release it.

Parts Kit

GP-1000 Pressure reducing valve

Kit name	Contents
Main valve kit	Main valve, Main valve spring, Gasket (for bottom of body)
Pilot valve kit	Pilot valve assembly (pilot valve, pilot valve seat, pilot valve spring, pilot spring plate, bolts), Pilot diaphragm, Strainer, Strainer gasket
Gasket kit	Piston ring, Inner ring, Gasket (for top of body), Gasket (for bottom of body), Gasket for strainer



Completely discharge the internal pressure from the valves before disassembly.

CAUTION Please refer to the manual attached to the product for procedures for installation and operation.

Disassembly and troubleshooting

Pressure Reducing Valve

GP-27

Disassembly of pilot valve

1. Detach the cap [5], loosen the lock nut [18], and then, turn the adjusting screw [17] counterclockwise to release the spring force (no compression).
2. Remove the bolt [23] and the spring chamber [4]. Then detach the adjusting spring [21], the spring plates [15][16], the spring plate follower [14], and the diaphragm [13]. Detach the diaphragm by using a tool with sharp edge applying to the cut part of the diaphragm.
3. Detach the pilot valve seat [11] by using a wiring spanner or a socket wrench, and then detach the pilot valve [10] and the pilot valve spring [20].

Disassembly of piston

1. Remove the bolt [23] and the top cover [3] from the body [1], and pull out the piston [8] and the cylinder [9].

Disassembly of main valve

1. Remove the bolt [23] and the bottom cover [2] from the body [1], and detach the main valve spring [19] and the main valve [6].

Precaution during reassembly

1. Check that there is no damage and scratches on the main valve [6], main valve seat [7], pilot valve [10], and pilot valve seat [11]. Any damage or scratches at the sealing surface lead to leakage.
2. Move sliding section two to three times and check that they move smoothly.
3. Replace the gaskets with new ones when reassembling.

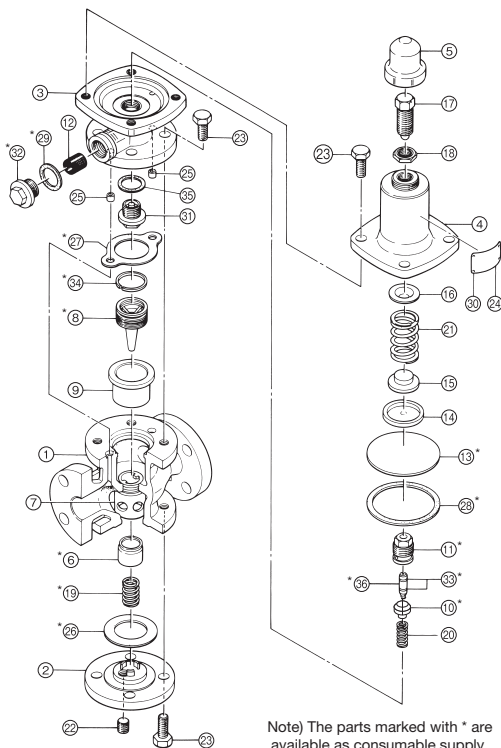

Note) The parts marked with * are available as consumable supply.

Parts

No.	Parts name	No.	Parts name	No.	Parts name	No.	Parts name
1	Body	10	Pilot valve	19	Main valve spring	28	Gasket (for diaphragm)
2	Bottom cover	11	Pilot valve seat	20	Pilot valve spring	29	Gasket (for strainer cap)
3	Top cover	12	Strainer	21	Adjusting spring	30	Rivet
4	Spring chamber	13	Diaphragm	22	Plug	31	Pilot valve cap
5	Cap	14	Spring plate follower	23	Bolt	32	Strainer cap
6	Main valve	15	Bottom spring plate	24	Name plate	33	Pilot valve ring
7	Main valve seat	16	Top spring plate	25	Guide pipe	34	Piston ring
8	Piston	17	Adjusting screw	26	Gasket (for bottom cover)	35	Gasket (for pilot valve cap)
9	Cylinder	18	Lock nut	27	Gasket (for top cover)	36	Pilot valve spindle



Completely discharge the internal pressure from the valves before disassembly.

Pressure Reducing Valve – Annex



CAUTION Please refer to the manual attached to the product for procedures for installation and operation.

Trouble	Cause	Remedy
Reduced pressure does not reach the desired value.	<ul style="list-style-type: none"> Working pressure is improper. Strainer is clogged. Foreign substances are stuck between piston and cylinder. Piston ring is damaged. Nominal size of the product is too small for the specifications of the system. Pressure adjustment is improper. Trouble with pressure gauge. 	<ul style="list-style-type: none"> Correct the working pressure. (Please refer to Specification selection chart.) Disassemble and clean. Disassemble and remove the foreign substances. Finish with sandpaper if scratches are found. Replace piston ring. Replace the product with one of proper nominal size. (Please refer to Nominal size selection chart.) Readjust the set pressure according to instructions. Replace the gauge.
Reduced pressure exceeds the set pressure.	<ul style="list-style-type: none"> Foreign substances are stuck between main valve and main valve seat, or either of the parts is damaged. Foreign substances are stuck between pilot valve and pilot valve seat, or either of the parts is damaged. Foreign substances are stuck between piston and cylinder. Trap is not provided on a dead-end line. By-pass stop valve leaks. 	<ul style="list-style-type: none"> Disassemble and remove the foreign substances. Lap the parts if scratches are found. Disassemble and remove the foreign substances. Lap the parts if scratches are found. Disassemble and remove the foreign substances. Finish with sandpaper if scratches are found. Install a trap. Repair or replace the by-pass stop valve.
Abnormal sound.	<ul style="list-style-type: none"> Nominal size is too large for the specifications. Too much high pressure reduction ratio. Condensate-induced trouble. A quick operating valve is installed near the product. 	<ul style="list-style-type: none"> Replace the product with the one of proper nominal size Reduce the pressure in two stages. Install a trap. Take as large distance as possible from the on-off valve.
Others	<ul style="list-style-type: none"> Springs and diaphragm are deteriorated. 	<ul style="list-style-type: none"> Replace the springs and diaphragm.



Completely discharge the internal pressure from the valves before disassembly.

**CAUTION**

Please refer to the manual attached to the product for procedures for installation and operation.

GD-30•30S**Disassembly**

1. Release the internal pressure from the valve completely.
2. Pull up and turn the handle counterclockwise (to the direction of "←" shown on the plate) to completely release the spring force (no compression).
3. Remove the bolt and the spring chamber, and detach the spring, bellows, and spindle. (Handle cannot be disassembled.)
4. Detach the cap by turning it counterclockwise, and then detach the spring, screen, and valve from the body.

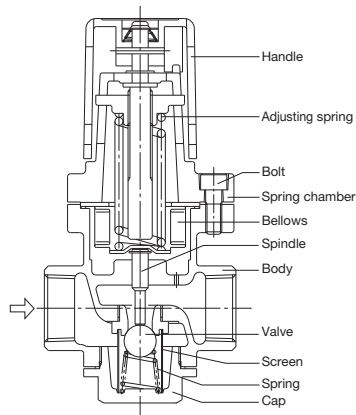
**Trouble****Cause****Remedy**

Reduced pressure does not reach the desired value.

- Working pressure is improper. Correct the working pressure.
- Nominal size of the product is too small for Replace the product with one of proper nominal size.
- Pressure adjustment is not proper. Readjust the set pressure according to instruction.
- Screen is clogged. Disassemble and clean.
- Trouble with pressure gauge. Replace the gauge.

Reduced pressure exceeds the set pressure.

- Foreign substances are stuck between valve and valve seat, or either of the parts is damaged. Disassemble and remove the foreign substances. Replace the parts if scratches are found.
- By-pass stop valve leaks. Repair or replace the by-pass stop valve.
- Foreign substances are stuck at reduced pressure sensing hole. Disassemble and remove the foreign substances.

Abnormal sound

- Too much high pressure reduction ratio. Reduce the pressure in two stages.
- Condensate-induced trouble. Install a trap.
- An on-off valve is installed near the product. Take as large distance as possible from the on-off valve.

Parts Kit**GD-30-45 Pressure reducing valve (Size: 15–25A)**

Kit name	Contents
Bellows kit	Bellows, Bellows gasket
Main valve kit	Valve, Spindle, Screen, Valve spring, Cap gasket, E-ring



Completely discharge the internal pressure from the valves before disassembly.

CAUTION Please refer to the manual attached to the product for procedures for installation and operation.

GD-45

Disassembly

1. Loosen the lock nut and the adjusting screw to release the adjusting spring force (no compression).
2. Remove the bolt and the spring chamber. Then detach the adjusting spring, spring plate, bellows, and spindle.
3. Loosen and detach the cap, and then detach the valve spring, screen, and the valve. (Please be careful about outflow of condensate.)

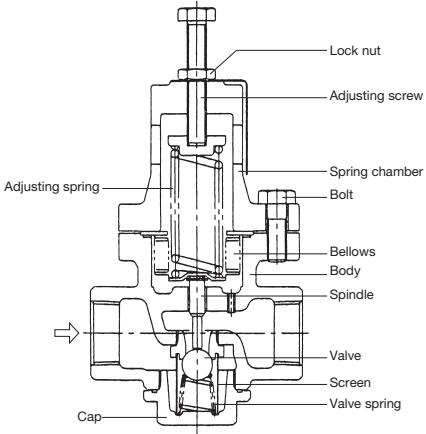

Trouble	Cause	Remedy
Reduced pressure does not reach the desired value.	● Working pressure is improper.	Correct the working pressure.
	● Nominal size of the product is too small for the specifications of the system.	Replace the product with one of proper nominal size.
	● Pressure adjustment is not proper.	Readjust the set pressure according to instruction.
	● Screen is clogged.	Disassemble and clean.
Reduced pressure exceeds the set pressure.	● Foreign substances are stuck between valve and valve seat, or either of the parts is damaged.	Disassemble and remove the foreign substances. Replace the parts if scratches are found.
	● Foreign substances are stuck at reduced pressure sensing hole.	Disassemble and remove the foreign substances.
	● By-pass stop valve leaks.	Repair or replace the by-pass stop valve.
Abnormal sound	● Too much high pressure reduction ratio.	Reduce the pressure in two stages.
	● Condensate-induced trouble.	Install a trap.
	● An on-off valve is installed near the product.	Take as large distance as possible from the on-off valve.

+ Completely discharge the internal pressure from the valves before disassembly.

CAUTION Please refer to the manual attached to the product for procedures for installation and operation.

GD-24

Disassembly of body and spring chamber

- Loosen the lock nut and turn the adjusting screw counterclockwise to spring force (No compression).
- Remove the bolts and the spring chamber, and then, detach the adjusting spring and the spring plate.
- Carefully peel the diaphragm off the flange against which the diaphragm is appressed. Be careful not to damage the diaphragm. And then, loosen the nut and take off the diaphragm.

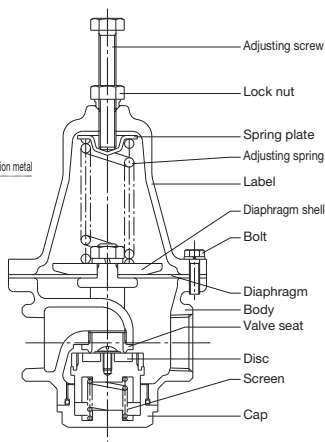
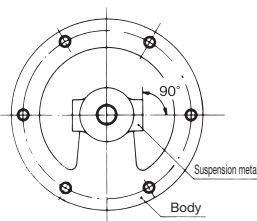

Disassembly of valve

- Detach the cap by turning it counterclockwise, and detach the spring.
- Detach the valve by turning it counterclockwise.

Precautions during reassembly

- Check that there is no damage and scratches on the diaphragm, valve, and valve seat. Any damage or scratches at the sealing surface lead to leakage.
- Before fastening the diaphragm, make sure to reassemble the body and the suspension metal according to the illustration.

Trouble	Cause	Remedy
Reduced pressure does not reach the desired value.	<ul style="list-style-type: none"> Strainer is clogged. Trouble with pressure gauge. 	<ul style="list-style-type: none"> Disassemble and clean. Replace the gauge.
Reduced pressure exceeds the set pressure.	<ul style="list-style-type: none"> Foreign substances are stuck between main valve and main valve seat, or either of the parts is damaged. Diaphragm is damaged. PRV is affected by back pressure. By-pass stop valve leaks. 	<ul style="list-style-type: none"> Disassemble and remove the foreign substances. Replace the parts if scratches are found. Replace the diaphragm. Check and eliminate the cause of back pressure. Repair or replace the by-pass stop valve.
Abnormal sound.	<ul style="list-style-type: none"> Air-induced trouble. Nominal size is too large for the specifications. An on-off valve is installed near the product. 	<ul style="list-style-type: none"> Install air vent. Replace the product with one of proper nominal size. Take as large distance as possible from the on-off valve.



Completely discharge the internal pressure from the valves before disassembly.

Pressure Reducing Valve – Annex

CAUTION Please refer to the manual attached to the product for procedures for installation and operation.

GD-41•43•41G•43G•41N•43N

Disassembly

1. Remove the nut and release the adjusting spring force (no compression).
2. Remove the set screws, adjusting screw, spring chamber, and adjusting spring.
3. Detach the cap and the spring.
Set two socket wrenches (nominal size 10) onto the U nut (near the diaphragm) and the nut (near the disc) at the same time, and detach the nut, washer, and disc. And then, take out the diaphragm set.

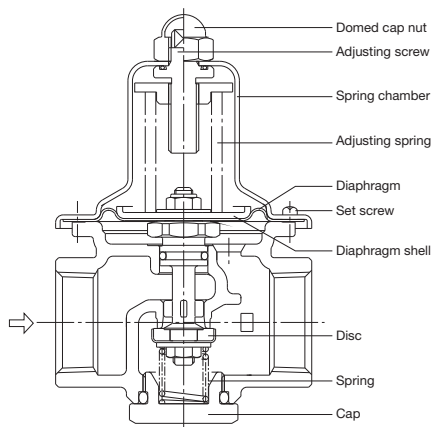

Trouble	Cause	Remedy
Reduced pressure exceeds the set pressure.	<ul style="list-style-type: none"> • Diaphragm is damaged. • Foreign substances are stuck between the disc and seating area, or either of the parts is damaged. • O ring for spindle is damaged. 	<ul style="list-style-type: none"> • Replace the diaphragm. • Disassemble and remove the foreign substances. Replace the parts if scratches are found. • Replace the O ring.
Reduced pressure does not reach the desired value. / Fluid does not flow.	<ul style="list-style-type: none"> • O ring for spindle gets stuck. • Disc and seating area get stuck. 	<ul style="list-style-type: none"> • Replace the O ring. • Disassemble and clean the parts. Replace the parts if scratches are found.
Outside leakage.	<ul style="list-style-type: none"> • Set screws got loose. • Cap got loose. • O ring for cap is damaged. 	<ul style="list-style-type: none"> • Tighten the screws. • Screw in the cap. • Replace the O ring.

+ Completely discharge the internal pressure from the valves before disassembly.

CAUTION Please refer to the manual attached to the product for procedures for installation and operation.

GD-26-NE

Disassembly of body and spring chamber

1. Remove the domed cap nut and turn the adjusting screw counterclockwise to release the adjusting spring force (no compression).
2. Remove the bolts of the spring chamber and detach the spring chamber. Then detach the adjusting spring and spring plate.
3. Remove the nut, and then diaphragm shell and diaphragm.

Disassembly of valve seat

1. Remove the set screw, and then detach the valve seat.

Precautions during reassembly

1. Check that there is no damage or scratch on the disc and the valve seat.
2. Apply grease to the O-rings.
3. Do not distort or twist the diaphragm.

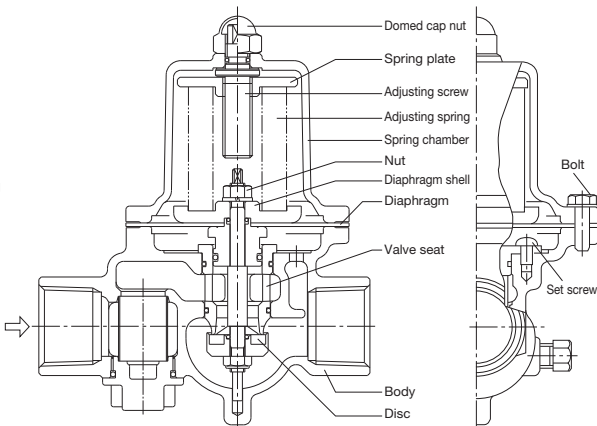

* The same procedures should be applied to GD-27-NE, -28-NE, -29-NE, and GD-26S, -27S, -26GS, -27 GS, -28S, -29S while disassembling and troubleshooting.

Trouble	Cause	Remedy
Reduced pressure does not reach the desired value.	● Working pressure is improper.	Correct the working pressure.
	● Nominal size of the product is too small for the specifications of the system.	Replace the product with the one of proper nominal size.
	● Pressure adjustment is not proper.	Readjust the set pressure according to instruction.
	● Strainer is clogged.	Disassemble and clean.
	● Trouble with pressure gauge.	Replace the gauge.
Reduced pressure exceeds the set pressure.	● Foreign substances are stuck between disc and valve seat, or either of the parts is damaged.	Disassemble and remove the foreign substances. Replace the parts if scratches are found.
	● O ring is damaged.	Replace the O ring.
	● Diaphragm is damaged.	Replace the diaphragm.
	● By-pass stop valve leaks.	Repair or replace the by-pass stop valve.
Abnormal sound.	● Nominal size is too large for the specifications.	Replace the product with one of proper nominal size
	● Too much high pressure reduction ratio.	Reduce the pressure in two stages.
	● Air-induced trouble.	Install air vent.
	● An on-off valve is installed near the product.	Take as large distance as possible from the on-off valve.
Outside leakage.	● Bolt got loose.	Tighten the bolt.
	● O ring is damaged.	Replace the O ring.
	● Strainer cap or plug got loose.	Tighten the strainer cap or the plug.



Completely discharge the internal pressure from the valves before disassembly.

Pressure Reducing Valve – Annex

CAUTION Please refer to the manual attached to the product for procedures for installation and operation.

GD-200

• **Disassembly of body and spring chamber**

1. Loosen the lock nut slightly and turn the adjusting screw counterclockwise to release the adjusting spring force (no compression).
2. Detach the bolt and the spring chamber. Then detach the adjusting spring and spring plates.
3. Detach the diaphragm by loosening the nut and fixing the spindle.

• **Disassembly of valve**

1. Loosen the retainer guide clamping bolt and pull up the retainer guide.

• **Precautions during reassembly**

1. Check that there is no damage and scratches on the diaphragm, valve, and valve seat.
2. Check that there is no damage and scratches on the O-ring, and then apply silicone grease to the O-ring.
3. There should be a gap between the retainer guide and the body. Tighten the bolts evenly and do not overtighten them.

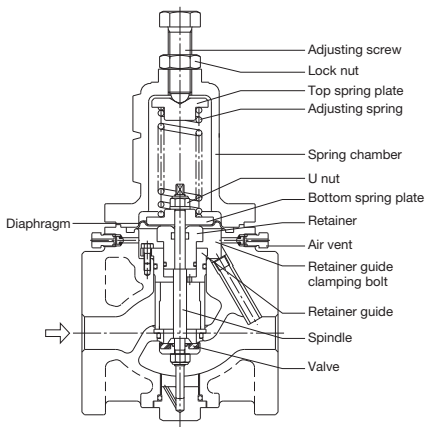

Trouble	Cause	Remedy
Reduced pressure does not reach the desired value.	• Working pressure is improper.	Correct the working pressure.
	• Foreign substances are stuck in conductor piping.	Disassemble and clean.
	• Nominal size of the product is too small.	Replace the product with the one of proper nominal size for the specifications of the system.
	• Pressure adjustment is not proper.	Readjust the set pressure according to instruction.
	• Strainer is clogged.	Disassemble and clean.
Reduced pressure exceeds the set pressure.	• Trouble with pressure gauge.	Replace the gauge.
	• Foreign substances are stuck between valve and valve seat, or either of the parts is damaged.	Disassemble and remove the foreign substances. Replace the parts if scratches are found.
	• O ring is damaged.	Replace the O ring.
Abnormal sound.	• By-pass stop valve leaks.	Repair or replace the by-pass stop valve.
	• Nominal size is too large for the specifications.	Replace the product with the one of proper nominal size.
	• Too much high pressure reduction ratio.	Reduce the pressure in two stages.
	• Air-induced trouble.	Install air vent.
Outside leakage.	• An on-off valve is installed near the product.	Take as large distance as possible from the on-off valve.
	• Diaphragm is damaged.	Replace the diaphragm.

+ Completely discharge the internal pressure from the valves before disassembly.

CAUTION Please refer to the manual attached to the product for procedures for installation and operation.

GD-27BP

Disassembly of body and spring chamber

1. Remove the domed cap nut and turn the adjusting screw counterclockwise to release the spring force (no compression).
2. Remove the bolt of the spring chamber. Detach the spring chamber, spring, and spring plate.
3. Remove the nut, and then detach the diaphragm shell and diaphragm.

Disassembly of disc

1. Remove the set screw of the valve seat, and detach a set of the valve seat.

Precaution for reassembly

1. Check that there is no damage or scratch on the disc and the valve seat.
2. Apply silicone grease to the O-ring.
3. Do not distort or twist the diaphragm.

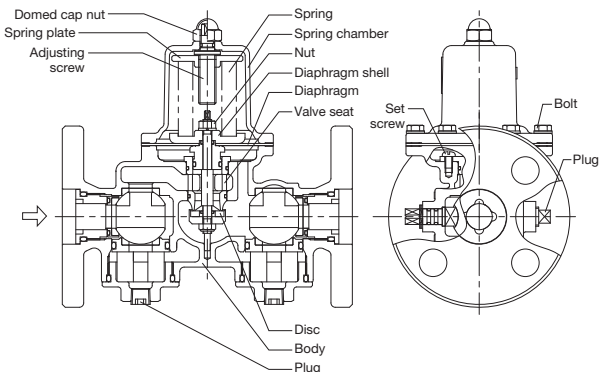

Trouble	Cause	Remedy
Reduced pressure does not reach the desired value.	<ul style="list-style-type: none"> Working pressure is improper. Nominal size of the product is too small for the specifications of the system. Pressure adjustment is not proper. Strainer before the product is clogged. Trouble with pressure gauge. Stop function is set. 	<ul style="list-style-type: none"> Correct the working pressure. Replace the product with the one of proper nominal size. Readjust the set pressure according to instruction. Disassemble and clean. Replace the gauge. Switch the functions.
Reduced pressure exceeds the set pressure.	<ul style="list-style-type: none"> Foreign substances are stuck between disc and valve seat, or either of the parts is damaged. O ring is damaged. Diaphragm is damaged. Packing at ball valve part is worn or damaged. By-pass function is set. 	<ul style="list-style-type: none"> Disassemble and remove the foreign substances. Replace the parts if scratches are found. Replace the O ring. Replaced the diaphragm. Please contact us. Switch the functions.
Abnormal sound.	<ul style="list-style-type: none"> Nominal size is too large for the specifications. Too much high pressure reduction ratio. Air-induced trouble. An on-off valve is installed near the product. 	<ul style="list-style-type: none"> Replace the product with one of proper nominal size. Reduce the pressure in two stages. Install air vent. Take as large distance as possible from the on-off valve.
Outside leakage.	<ul style="list-style-type: none"> Bolts got loose. Plugs (at the caps) are loosened. Plugs (on the side of body) are loosened. 	<ul style="list-style-type: none"> Tighten the bolts. Tighten the plug. Tighten the plug.

+ Completely discharge the internal pressure from the valves before disassembly.

Pressure Reducing Valve – Annex

CAUTION Please refer to the manual attached to the product for procedures for installation and operation.

GD-9

Disassembly of valve

1. Turn the valve guide counterclockwise and detach it. Then, detach the valve spring and valve assembly.

Disassembly of diaphragm

1. Slightly loosen the locknut (only for 25A), and turn the handle counterclockwise to release the spring (no compression).
2. Remove the bolts on the bonnet, and detach the bonnet from the body. Then, take out the spring plate, spring, and diaphragm assembly.

Precaution for reassembly

1. Check that there is no damage or scratch on the valve and the valve seat.
2. Apply grease to the O-ring.
3. Do not distort or twist the diaphragm. Assemble the diaphragm to the specified place.

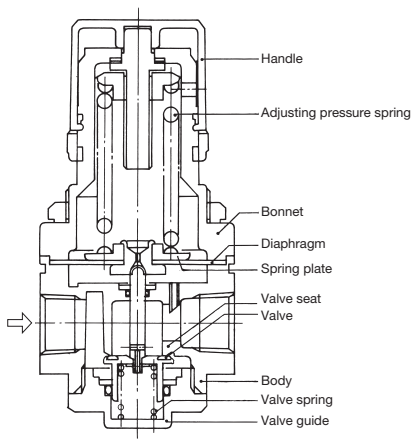

Trouble	Cause	Remedy
Reduced pressure cannot be adjusted.	<ul style="list-style-type: none"> ● Product is installed in opposite direction. ● Adjusting pressure spring is damaged. ● Valve spring is damaged. ● Foreign substances are stuck at valve seat or at valve O-ring. ● Rubber lining of valve is damaged. 	<ul style="list-style-type: none"> Check the direction of flow and install in the right direction. Replace the adjusting pressure spring. Replace the valve spring. Detach the valve guide assembly and clean the valve, valve seat, and O-rings. Apply grease to the O-rings and sliding parts after cleaning. Replace the valve.
Set pressure does not lower when the handle is loosened.	<ul style="list-style-type: none"> ● Foreign substances are stuck at valve seat or at valve O-ring. ● Rubber material of valve is damaged. ● Valve spring is damaged. ● Valve is stuck..... 	<ul style="list-style-type: none"> Detach the valve guide assembly and clean the valve, valve seat, and O-rings. Apply grease to the O-rings and sliding parts after cleaning. Replace the valve. Replace the valve spring. Clean the sliding surfaces of valve O-rings, and apply grease to them.
Air leaks from air ventilation hole on bonnet.	<ul style="list-style-type: none"> ● Diaphragm is damaged. ● Piston packing is damaged. ● Foreign substances are stuck at seat of air vent. ● Foreign substances are stuck at valve seat or at valve ring. ● Rubber material of valve is damaged. ● Back pressure exceeding the set pressure exists. 	<ul style="list-style-type: none"> Replace the diaphragm assembly. Replace or clean the piston assembly. Apply grease to the piston packing and sliding surfaces. Clean the seat of air vent, or replace the diaphragm assembly. Detach the valve guide assembly and clean the valve, valve seat, and O-rings. Apply grease to the O-rings and sliding parts after cleaning. Replace the valve. Change the air piping to prevent back pressure exceeding the set pressure.
Air leaks between bonnet and body.	<ul style="list-style-type: none"> ● Bolts on bonnet got loose. ● Diaphragm is damaged. 	<ul style="list-style-type: none"> Tighten the bolts. Replace the diaphragm assembly.

+ Completely discharge the internal pressure from the valves before disassembly.

CAUTION Please refer to the manual attached to the product for procedures for installation and operation.

GD-4

Disassembly of valve and diaphragm

1. Remove the cap, slightly loosen the lock nut, and turn the adjusting screw counterclockwise to release the adjusting spring force (no compression).
2. Remove the bolts of the upper diaphragm cover. Detach the upper diaphragm cover, and then take out the spring plate and the adjusting spring.
3. Remove the locknuts, and detach the washer of diaphragm and diaphragm.
4. Remove the bolts of the lower diaphragm cover. Detach the lower diaphragm cover, and loosen the lock nut of spindle joint. Then, detach the spindle joint and spindle. (It is recommended that you put marking on the parts with an oil-based pen before loosening the lock nut, so that you can easily reassemble.)
5. Remove the bolts of bottom cover, and detach the bottom cover and the valve.

(Note) To detach only the valve for the product of 50A or smaller, you can skip No.2 to 4 above.

Precaution during reassembly

1. Check that there is no damage and scratches on the valve and the valve seat.
2. Do not distort or twist the diaphragm. Assemble the diaphragm to the specified place.

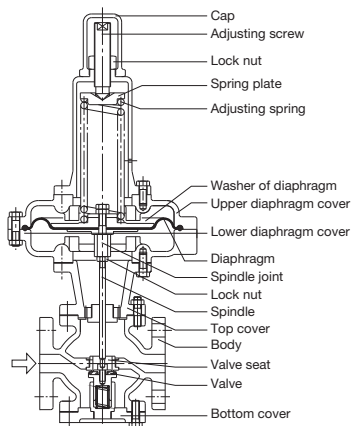

Trouble	Cause	Remedy
Reduced pressure does not reach the desired value.	● Working pressure is improper.	Correct the working pressure.
	● Nominal size of the product is too small for the specifications of the system.	Replace the product with the one of proper nominal size.
	● Pressure adjustment is not proper.	Readjust the set pressure according to instruction.
	● Strainer before the product is clogged.	Disassemble and clean.
Reduced pressure exceeds the set pressure.	● Trouble with pressure gauge.	Replace the gauge.
	● Foreign substances are stuck between valve and valve seat, or either of the parts is damaged.	Disassemble and remove the foreign substances. Lap the valve and valve seat if scratches are found. (Replace the valve for 50A or smaller.)
	● Diaphragm is damaged.	Replaced the diaphragm.
Abnormal sound.	● By-pass stop valve leaks.	Repair or replace the by-pass stop valve.
	● Nominal size is too large for the specifications.	Replace the product with one of proper nominal size
	● Too much high pressure reduction ratio.	Reduce the pressure in two stages.
	● An on-off valve is installed near the product.	Take as large distance as possible from the quick operating valve.

+ Completely discharge the internal pressure from the valves before disassembly.

Pressure Reducing Valve – Annex

CAUTION Please refer to the manual attached to the product for procedures for installation and operation.

GD-6

Disassembly of valve

1. Remove the bottom cap by turning it counterclockwise, and then detach the spring and the valve.

Disassembly of diaphragm

1. Slightly loosen the lock nut, and turn the adjusting screw counterclockwise to release the adjusting spring force (no compression).
2. Remove the bolts of the spring chamber, and detach the spring chamber. Then, detach the washer of spring, adjusting spring, and the diaphragm.

Precaution during reassembly

1. Check that there is no damage and scratches on the valve and the valve seat.

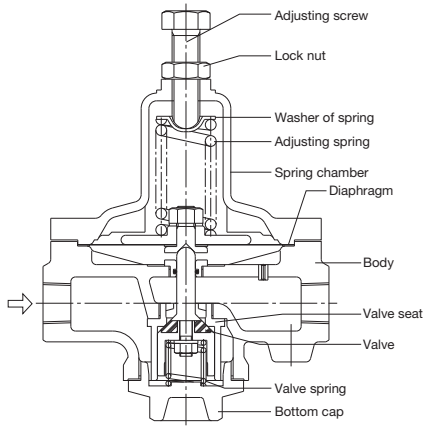

Please note that GD-6N has different structure.

Trouble	Cause	Remedy
Reduced pressure does not reach the desired value.	• Working pressure is improper.	Correct the working pressure.
	• Foreign substances are stuck in reduced pressure sensing port.	Disassemble and clean.
	• Nominal size of the product is too small for the specifications of the system.	Replace the product with the one of proper nominal size.
	• Pressure adjustment is not proper.	Readjust the set pressure according to instruction.
	• Strainer is clogged.	Disassemble and clean.
Reduced pressure exceeds the set pressure.	• Trouble with pressure gauge.	Replace the gauge.
	• Foreign substances are stuck between valve and valve seat, or either of the parts is damaged. ...	Disassemble and remove the foreign substances. Lap the parts if scratches are found. (Replace the parts if the valve has scratches.)
Abnormal sound.	• By-pass stop valve leaks.	Repair or replace the by-pass stop valve.
	• Too much high pressure reduction ratio.	Reduce the pressure in two stages.
	• Condensate-induced trouble. (If the fluid is steam)	Install trap.
	• Air-induced trouble. (If the fluid is liquid)	Install air vent.
	• An on-off valve is installed near the product.	Take as large distance as possible from the on-off valve.

+ Completely discharge the internal pressure from the valves before disassembly.



Please refer to the manual attached to the product for procedures for installation and operation.

GD-7

Disassembly of valve and diaphragm

1. Remove the cap, slightly loosen the lock nut, and then turn the adjusting screw counterclockwise to release the adjusting spring force (no compression).
2. Remove the nut holding the cylinder, and then detach the spring chamber, the spring plate, and the adjusting spring.
3. Remove the nut holding the piston, and then detach the piston and the cylinder.
4. Remove the nut holding the bottom cover, and then detach the bottom cover and the valve.

Precautions during reassembly

1. Check that there is no damage and scratches on the valve and the valve seats.
2. Apply grease to O rings.

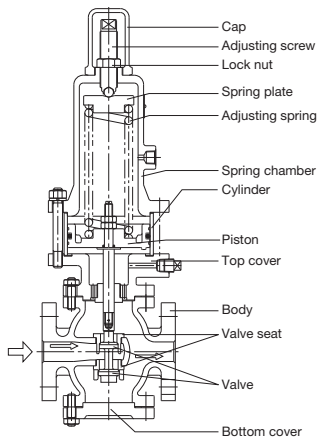

Trouble	Cause	Remedy
Reduced pressure does not reach the desired value.	<ul style="list-style-type: none"> Working pressure is improper. Nominal size of the product is too small for the specifications of the system. Pressure adjustment is not proper. Strainer is clogged. Trouble with pressure gauge. 	<ul style="list-style-type: none"> Correct the working pressure. Replace the product with the one of proper nominal size. Readjust the set pressure according to instruction. Disassemble and clean. Replace the gauge.
Reduced pressure exceeds the set pressure.	<ul style="list-style-type: none"> Foreign substances are stuck between valve and valve seat, or either of the parts is damaged. O ring for piston is damaged. By-pass stop valve leaks. 	<ul style="list-style-type: none"> Disassemble and remove the foreign substances. Lap the parts if scratches are found. Replace the O ring. Repair or replace the by-pass stop valve.
Abnormal sound.	<ul style="list-style-type: none"> Too much high pressure reduction ratio. Air-induced trouble. An on-off valve is installed near the product. 	<ul style="list-style-type: none"> Reduce the pressure in two stages. Install air vent. Take as large distance as possible from the on-off valve.
Fluctuation in reduced pressure.	<ul style="list-style-type: none"> Grease peels off from piston. 	<ul style="list-style-type: none"> Apply grease to sliding surface of piston and groove for O ring.



Completely discharge the internal pressure from the valves before disassembly.

Pressure Reducing Valve – Annex

CAUTION Please refer to the manual attached to the product for procedures for installation and operation.

GD-8N

• Disassembly of valve

1. Detach the screws of the valve guide, detach the valve guide from the body, and then take out the valve spring, valve, and the diaphragm set.

• Disassembly of diaphragm

1. Turn the handle counterclockwise to release the adjusting spring force (no compression).
2. Detach the screws of the spring chamber, detach the spring chamber from the body, and then take out the adjusting spring and diaphragm assembly.

• Precaution for reassembly

1. Check that there is no damage or scratch on the valve and the valve seat.
2. Do not distort or twist the diaphragm. Assemble the diaphragm to the specified place.

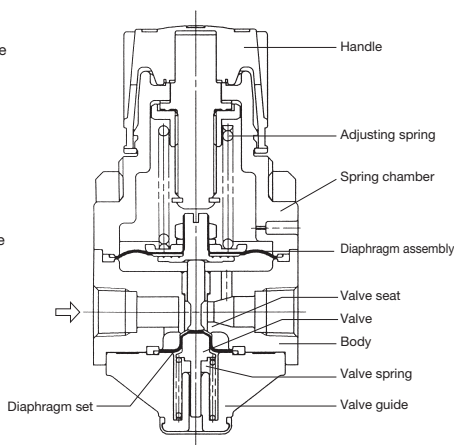

Trouble	Cause	Remedy
Reduced pressure cannot be adjusted.	<ul style="list-style-type: none"> • Product is installed in opposite direction. • Adjusting spring or valve spring is damaged. ... • Foreign substances are stuck on the diaphragm at valve side. • Diaphragm at valve side is damaged. 	<ul style="list-style-type: none"> Check the direction of flow and install in the right direction. Replace the damaged spring. Detach the valve guide and clean the diaphragm at the valve side. Replace the diaphragm.
Fluid flows out from between the spring chamber and the valve.	<ul style="list-style-type: none"> • Diaphragm of the diaphragm assembly is damaged. • Spring chamber is loosened. 	<ul style="list-style-type: none"> Replace the diaphragm. Tighten the spring chamber.
Fluid flows out from a hole on the spring chamber.	<ul style="list-style-type: none"> • Diaphragm of the diaphragm assembly is damaged. 	<ul style="list-style-type: none"> Replace the diaphragm.

+ Completely discharge the internal pressure from the valves before disassembly.

