

FIG.277

 CHECK VALVE zCHE



Body material	Nominal pressure	Nominal diameter	Max. temperature
A Grey cast iron	C 16 bar	DN 10-50	200°C









correspond to the pressure equipment directive 2014/68/UE marking CE for DN≥32

**FEATURES**

- closing thightness (class D acc. to EN -12266-1)
- compact settlement
- environment-friendly
- no maintenance

**APPLICATION**

industries				
	INDUSTRY	HEATING		
media				
	INDUSTRIAL WATER	STEAM	COMPRESSED AIR	NEUTRAL FLUIDS

Data given can be changed without notice.

Edition 01/2018

**MATERIALS, DIMENSIONS**

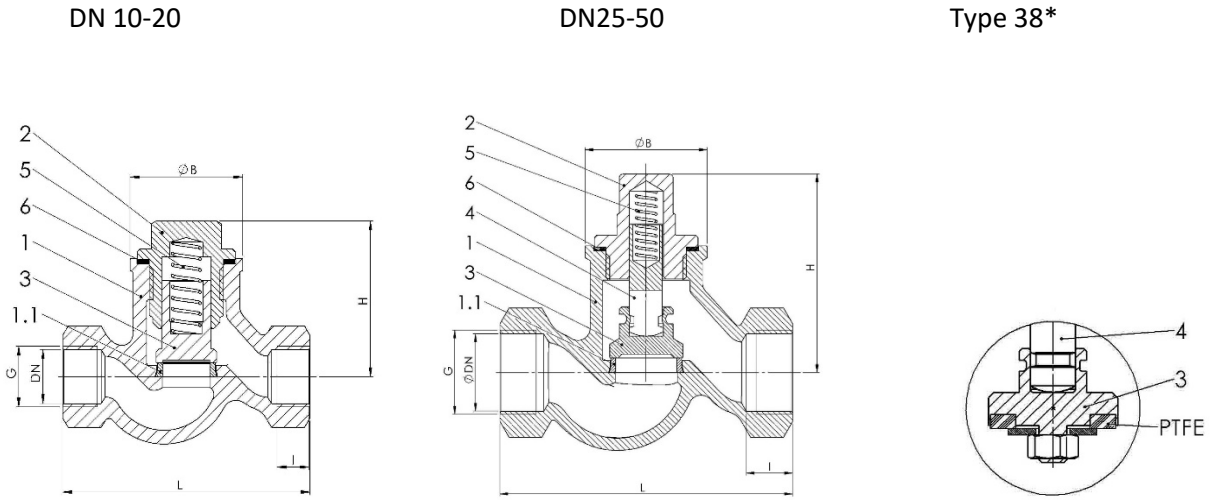

	Body material	A				
		Type	31 (DN 10-20)	31 (DN 25-50)	38 (DN 10-50) *	41 (DN 10-20)
1	Body	EN – GJL-250 5.1301 (ex. JL1040)				
1.1	Seat ring	X20Cr13 1.4021				
2	Bonnet	EN – GJL-250 5.1301 (ex. JL1040)				
3	Disc	X20Cr13 1.4021		X20Cr13 1.4021 + PTFE		X20Cr13 1.4021
4	Stem	-	X20Cr13 1.4021		-	X20Cr13 1.4021
5	Spring	X17CrNi16-2 1.4057			-	
6	Gasket	Carbamide-caoutchouc				
<b>Max. temperature</b>		<b>200°C</b>				

\*max. temp 120°C

DN	10	15	20	25	32	40	50
cal	3/8"	1/2"	3/4"	1"	1 1/4"	1 1/2"	2"
L	85	90	100	120	140	170	200
I	12	14	16	18	20	22	24
H	53	56	56	82	99	112	121
B	36	41	41	50	60	68	84
Kvs	2,24	4,58	5,57	9,29	14,5	24,4	39,8
Weight	0,4	0,7	0,9	1,2	1,7	2,2	3,6

Data given can be changed without notice.

Edition 01/2018

ZETKAMA Sp. z o.o.  
Ul. 3 Maja 12  
PL 57-410 Ścinawka Średnia

Tel. +48 74 8652 193  
Tel. +48 74 8652 111  
Fax +48 74 8652 199

E-mail export@zetskama.com.pl  
www.zetskama.com

**PRESSURE-TEMPERATURE RATINGS**

Acc. EN 1092-2	PN		-10÷120	150	180	200
EN-GJL-250	16	bar	16	14,4	13,4	12,8

**TYPE**

Figure	Body material	Nominal diameter	Nominal pressure	Type
277	A Grey cast iron EN-GJL-250	10-50 mm	C 16 bar	31 loose disc with spring; stem, disc and seat ring - stainless steel
				38 loose disc with spring; stem, disc and seat ring - stainless steel; disc gasket PTFE (120°C)
				41 loose disc without spring; stem, disc and seat ring - stainless steel

**ORDERING**

Figure	Body material	Nominal diameter	Nominal pressure	Type
277	A Grey cast iron EN-GJL-250	10-50 mm	C 16 bar	31 loose disc with spring; stem, disc and seat ring - stainless steel

**Order example acc. index**

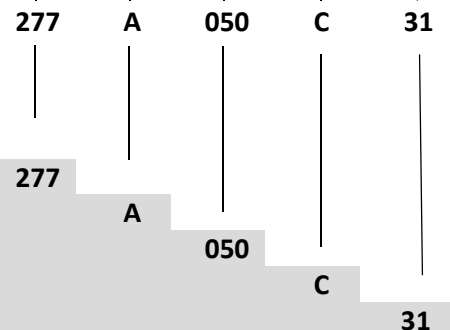

Check valves, ends threaded, form straight  
 Grey cast iron EN-GJL-250  
 Nominal diameter DN40  
 Nominal pressure PN16  
 Loose disc with spring; stem, disc and seat ring stainless steel

Data given can be changed without notice.

Edition 01/2018