

Bronze Ball Valves

Two-Piece Body • Full Port • Bronze Trim • Single Union Ends • Blowout-Proof Stem

600 PSI/41.4 bar non-shock cold working pressure
150 PSI/10.3 bar saturated steam**

CONFORMS TO MSS SP-110

MATERIAL LIST

PART	SPECIFICATION
1. Handle Nut	Zinc Plated Steel
2. Handle	Zinc Plated Steel Clear Chromate Plastisol Coated
3. Threaded Pack Gland	Brass ASTM B 16 Alloy C36000
4. Packing	PTFE
5. Thrust Washer	Reinforced PTFE
6. Stem	Silicon Bronze ASTM B 371 Alloy C69300 or ASTM B 99 Alloy C65100
7. Ball	Brass ASTM B 124 Alloy C37700 or ASTM B16 Alloy C36000 EACH with Hard Chrome Plate
8. Seat Ring (2)	Reinforced PTFE
9. O-Ring	FKM
10. Tail Piece	ASTM B 124 Alloy C37700
11. Union Nut	ASTM B 124 Alloy C37700 or ASTM B 584 Alloy C84400
12. Body End	ASTM B 124 Alloy C37700
13. Body	Bronze ASTM B 584 Alloy C84400



TS-585-70-SU
Threaded x Solder



ST-585-70-SU
Solder x Threaded

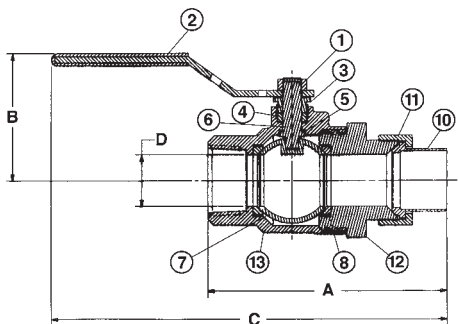

TS-585-70-SU
NPT x C

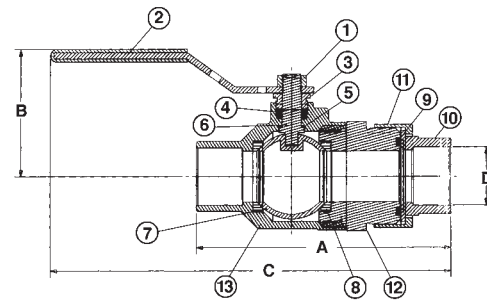

ST-585-70-SU
C x NPT

DIMENSIONS—WEIGHTS—QUANTITIES

Dimensions

Size	ST-585-70-SU		TS-585-70-SU		ST-585-70-SU		TS-585-70-SU		D	ST-585-70-SU		TS-585-70-SU		Master Ctn. Qty.
	In.	mm.	In.	mm.	In.	mm.	In.	mm.		Lbs.	Kg.	Lbs.	Kg.	
½	15	3.53	90	3.21	82	1.88	48	6.22	158	6.00	152	1.21	.55	40
¾	20	4.22	107	4.10	104	2.25	57	7.28	185	7.25	184	1.84	.84	20
1	25	4.86	123	4.91	125	2.38	60	7.66	195	7.83	199	2.91	1.32	20
1¼	32	5.79	147	5.63	143	3.00	76	9.97	253	10.23	260	4.39	2.00	10
1½	40	6.63	168	6.28	160	3.16	80	10.40	264	10.81	275	6.44	2.93	6
2	50	7.10	180	6.89	175	3.50	89	10.50	267	10.91	277	9.44	4.29	4

* Consult MSS SP123 for pressure temperature limitations

♦ For detailed operating pressure, refer to pressure temperature chart on page 42.

WARNING: This product can expose you to chemicals including lead, which is known to the State of California to cause cancer and birth defects or other reproductive harm. For more information go to www.P65Warnings.ca.gov.

Visit our website for the most current information.