

Victaulic® FireLock™ Series FL-SA/GAP and FL-SA/BB Specific Application Back-To-Back Attic Protection Scheme, Quick Response Upright, K5.6 (8.0), K8.0 (11.5)



FL-SA/DS, V5621



FL-SA/GAP, V5623

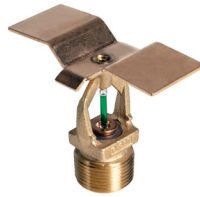

FL-SA/BB, V8122

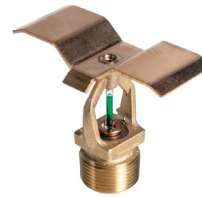

FL-SA/BB, V8123



FL-SA/BB, V8124

1.0 PRODUCT DESCRIPTION

SPECIFIC APPLICATION ATTIC SPRINKLERS					
SIN	V5621	V5623	V8122	V8123	V8124
ORIENTATION	UPRIGHT	UPRIGHT	UPRIGHT	UPRIGHT	UPRIGHT
K-FACTOR ¹	5.6 Imp./8.1 S.I.	5.6 Imp./8.1 S.I.	8.0 Imp./11.5 S.I.	8.0 Imp./11.5 S.I.	8.0 Imp./11.5 S.I.
CONNECTION	½" NPT/15mm BSPT	½" NPT/15mm BSPT	¾" NPT/ 20mm BSPT	¾" NPT/ 20mm BSPT	¾" NPT/ 20mm BSPT
MAX. WORKING PRESSURE	175 psi (1200 kPa)	175 psi (1200 kPa)	175 psi (1200 kPa)	175 psi (1200 kPa)	175 psi (1200 kPa)
GLOBE RE-DESIGNATION	GL5621	GL5623	GL8122	GL8123	GL8124

AVAILABLE WRENCHES		
SPRINKLER	V56 Open End	V81 Open End
Upright	■	■

Factory Hydrostatic Test: 100% @ 500 psi/3447 kPa/34 bar

Min. Operating Pressure: UL: 7 psi/48 kPa/5 bar

Temperature Rating: See tables in section 2.0

¹ For K-Factor when pressure is measured in bar, multiply S.I. units by 10.0.

2.0 CERTIFICATION/LISTINGS



Sprinkler Model	SIN	Nominal K Factor Imperial	Listing Agency/ Approved Temperature Ratings	Area of Use	Maximum Roof Span ft	Roof Pitch
BB46	V8122	8.0	cULus 200°F/93°C	RIDGE/GABLE	60	4:12 to less than 7:12
BB46/GAP	V8122/V5623	8.0/5.6	cULus 200°F/93°C	RIDGE/GABLE and GAP at EAVE	84	4:12 to less than 7:12
BB79	V8123	8.0	cULus 200°F/93°C	RIDGE/GABLE	60	7:12 to less than 10:12
BB79/GAP	V8123/V5623	8.0/5.6	cULus 200°F/93°C	RIDGE/GABLE and GAP at EAVE	84	7:12 to less than 10:12
BB1012	V8124	8.0	cULus 200°F/93°C	RIDGE/GABLE	60	10:12 to 12:12
BB1012/GAP	V8124/V5623	8.0/5.6	cULus 200°F/93°C	RIDGE/GABLE and GAP at EAVE	84	10:12 to 12:12
GAP	V5623	5.6	cULus 200°F/93°C	EAVE/HIP	N/A	SEE LAYOUT CRITERIA
DS	V5621	5.6	cULus 200°F/93°C	HIP/SINGLE SLOPE	N/A	SEE LAYOUT CRITERIA

NOTES

- Listings and approval as of printing.
- Listed to be utilized per NFPA 13 in conformance with the New Technology and Equivalency Sections.

ALWAYS REFER TO ANY NOTIFICATIONS AT THE END OF THIS DOCUMENT REGARDING PRODUCT INSTALLATION, MAINTENANCE OR SUPPORT.



3.0 SPECIFICATIONS – MATERIAL

Deflector: Bronze

Bulb Nominal Diameter: 3.0 mm

Load Screw: Brass

Pip Cap: Brass

Spring Seal Assembly: PTFE coated Beryllium nickel alloy

Frame: Brass

Lodgement Spring: Stainless steel

Installation Wrench: Ductile iron

Sprinkler Frame Finishes: Plain brass

NOTE

- For cabinets and other accessories refer to separate sheet.

4.0 DIMENSIONS

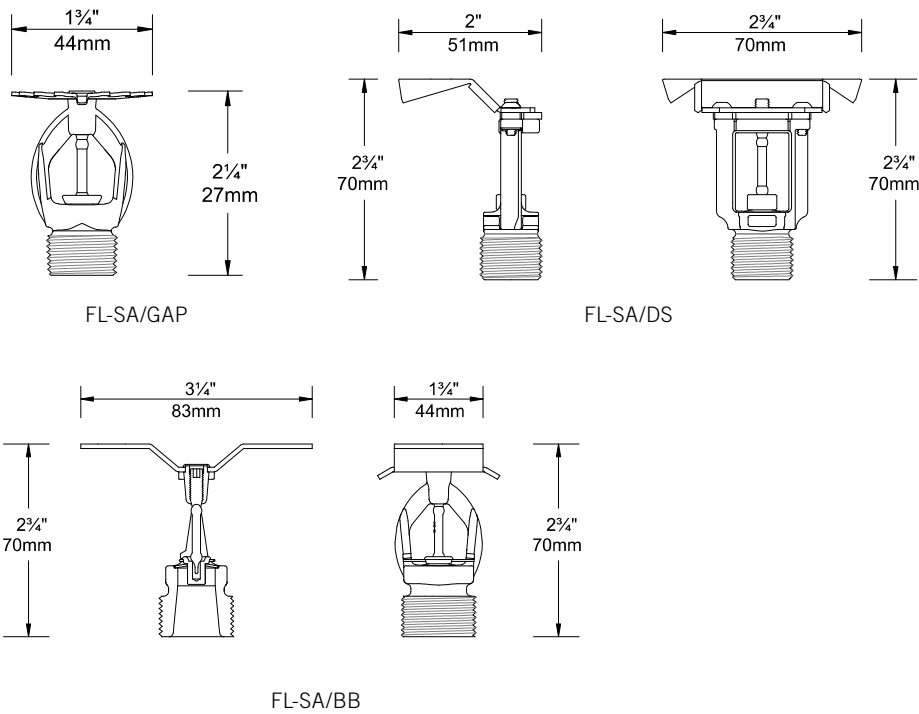

5.0 PERFORMANCE

Sprinkler Selection

Identify Areas of the Attic

- Identify each space in your attic as a Gable area, a Hip area or a Single Slope area. Refer to Figure 1 and Figure 5 through Figure 8 to choose the appropriate use of sprinklers for your application.

Gable/Peak and Eave Areas

- The areas in which the Model FL-SA/BB can be used are areas of the attic space where the roof joists/ trusses run perpendicular to the ridgeline. In the areas where the structure is perpendicular to the ridgeline and the attic span is in both directions of the ridgeline the Model FL-SA/BB shall be used. In each of the areas being protected with the Model FL-SA/BB sprinklers, identify the pitch/slope of the roof in that area. Ensure that the correct Model FL-SA/BB is chosen from the Table 1 based on the pitch/slope.
- The span must be identified in the area being protected by the Model FL-SA/BB. If the total span of the attic is over 60 ft, a row of Model FL-SA/ GAP sprinklers must be located near the eave in accordance with Figure 5 Option 2 and the layout rules must be in accordance with Figure 9 and Figure 10.

Single Slope Areas

- Single Slope areas are similar to the Gable/ Peak areas, except a vertical wall or obstruction impede the flow of hot gasses to the apex or is located directly at the apex of the attic space. When the hot gasses hit a vertical obstruction the gasses keep much of their velocity and tend to travel along the ridgeline. In a true gable with an apex and sloped ceiling on both sides, the hot gasses tend to run up one side of the gable roof and partly down the other section. This decreases the velocity of the gasses running along the gable section. Ensure the spacing rules are followed in accordance with Figure 11.

Under-Hip Areas

- With Hip areas the important features to identify in the under-hip areas are the structural members. It is important to identify if the structural members run parallel to the slope or perpendicular to the slope ("Step Down" trusses). If the structural members run parallel to the slope, use Figure 13 or Figure 14. If the structural members are "Step Down" trusses framed into "Jack" trusses use Figure 12.

Adjacent-Hip Areas

- In the Adjacent-HIP areas, either the Model FL-SA/ GAP or the Model FL-SA/DS sprinklers can be used. If using Model FL-SA/DS refer to Figure 15 and if using Model FL-SA/GAP refer to Figure 16.

TABLE 1: SPRINKLER SELECTION CRITERIA

SPRINKLER MODEL	SIN	AREA OF USE	K FACTOR	SPAN	ROOF PITCH
BB46	V8122	RIDGE/GABLE	8	MAX 60 ft	4:12 to less than 7:12
BB46/GAP	V8122/ V5623	RIDGE/GABLE and at EAVE	8.0/5.6	MAX 84 ft	4:12 to less than 7:12
BB79	V8123	RIDGE/GABLE	8	MAX 60 ft	7:12 to less than 10:12
BB79/GAP	V8123/ V5623	RIDGE/GABLE and at EAVE	8.0/5.6	MAX 84 ft	7:12 to less than 10:12
BB1012	V8124	RIDGE/GABLE	8	MAX 60 ft	10:12 to 12:12
BB1012/GAP	V8124/ V5623	RIDGE/GABLE and at EAVE	8.0/5.6	MAX 84 ft	10:12 to 12:12
GAP	V5623	EAVE/HIP	5.6	NA	SEE LAYOUT CRITERIA
DS	V5621	HIP/SINGLE SLOPE	5.6	NA	SEE LAYOUT CRITERIA

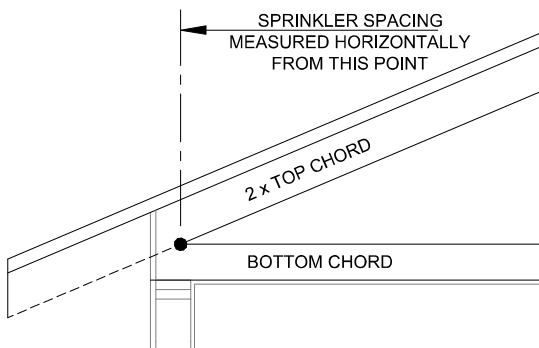

FIGURE 4A

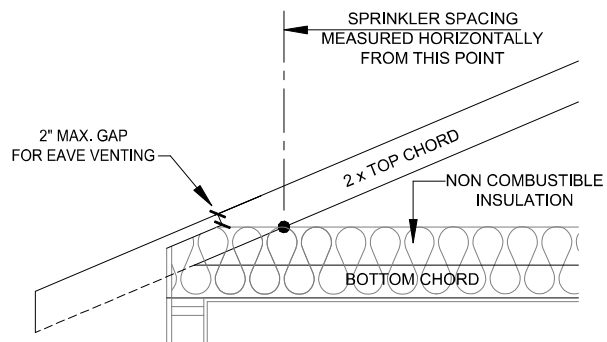

FIGURE 4B

FIGURE 4: SPAN MEASUREMENT/SPRINKLER SPACING LOCATIONS

5.0 PERFORMANCE (CONTINUED)

Sprinkler Selection

Gable Style Roof Option 1:

FL-SA/BB Sprinklers Only at Gable/Peak

- When utilizing this option, Model FL-SA/BB sprinklers are used to protect the entire width of the attic space. The span of the attic is measured along the floor (or ceiling of floor below) of the attic space from the peak to the intersection of the top chord and bottom chord of the roof trusses. See Figure 5a and Figure 5b. The span is twice the longer of the two measured half spans.
- The maximum span that can be protected by a single line of FL-SA/BB sprinklers at the peak is 60 ft.
- See minimum required flow rates and pressures for spans up to 40 ft. and spans over 40 ft. and up to 60 ft. is shown in Table 2 of this data sheet.
- See Figure 9 for detailed layout criteria.

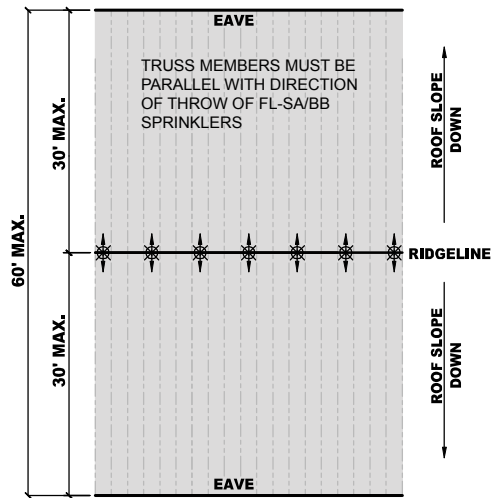

FIGURE 5A

Gable Style Roof Option 2:

FL-SA/BB Sprinklers And FL-SA/GAP Sprinklers Adjacent

- This option utilizes the FL-SA/BB sprinklers at the Gable/Peak and FL-SA/GAP sprinklers at the eave areas. With this option, a maximum total span of 84 ft. can be achieved. The FL-SA/BB may cover a maximum horizontal span of 60 ft. as stated in Option 1 above. GLSS/ GAP sprinklers may be used in conjunction with the FL-SA/BB sprinklers to achieve up to an additional 12 ft. measured horizontally to each eave. It should be noted that the "zone of coverage" for the "GAP" sprinklers is only measured from the centerline of the sprinkler to the eave. No credit for coverage "upslope" can be assumed.
- See Figure 9 and Figure 10 for detailed layout criteria.

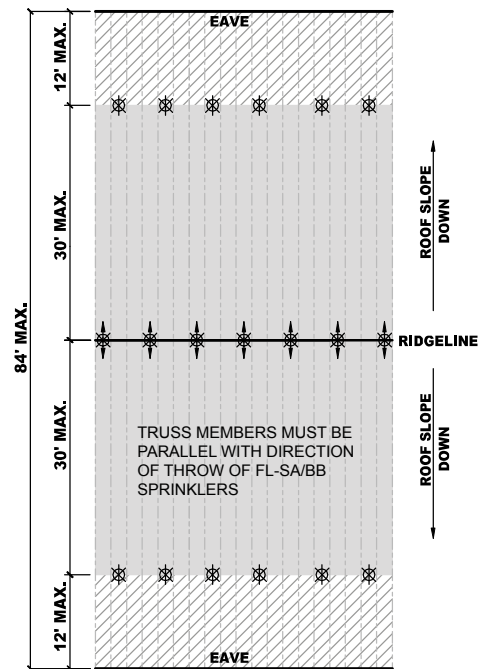
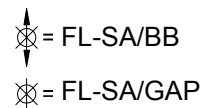

FIGURE 5B

FIGURE 5: PROTECTION OPTIONS



5.0 PERFORMANCE (CONTINUED)

Sprinkler Selection

Single Slope Roof Option 1:

FL-SA/DS Sprinklers at the Highpoint Only

- When utilizing this option, Model FL-SA/DS sprinklers are used to protect the entire width of the attic space from the eave to the vertical barrier of the single slope. The span of the attic is measured along the floor (or ceiling of floor below) of the attic space from the peak/vertical barrier to the intersection of the top chord and bottom chord of the roof trusses. See Figure 4a and Figure 4b.
- The maximum span that can be protected by a single line of FL-SA/DS sprinklers at the peak is 16 ft or 30 ft (measured horizontally from the sprinkler to eave).
- See Figure 11A and Figure 11B for detailed sprinkler layout criteria.

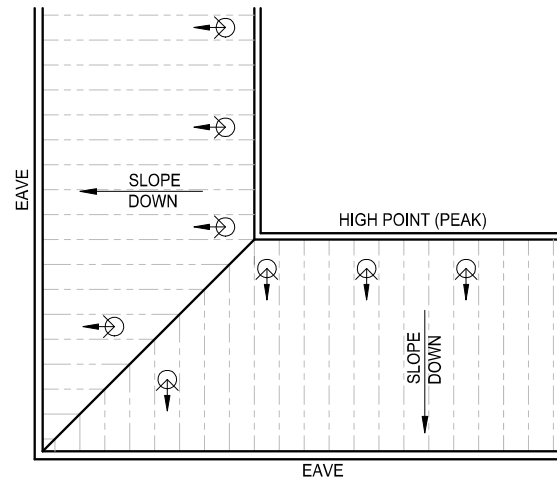

Single Slope Roof Option 2:

FL-SA/DS Sprinklers at the Highpoint and Downslope

- When utilizing this option, Model FL-SA/DS sprinklers are used to protect the entire width of the attic space from the eave to the vertical barrier of the single slope. The span of the attic is measured along the floor (or ceiling of floor below) of the attic space from the peak to the intersection of the top chord and bottom chord of the roof trusses. See Figure 4a and Figure 4b.
- The maximum span that can be protected by two lines of FL-SA/DS sprinklers at the peak is 32 ft + (depending on sprinkler placement).
- See Figure 11A and Figure 11C for detailed sprinkler layout criteria.

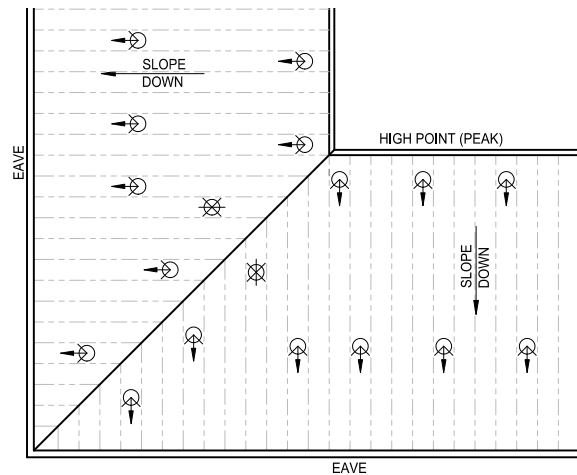

FIGURE 6: SINGLE SLOPE PROTECTION OPTIONS

- ⊗ = Model Gap
- ⊙ = Model DS

5.0 PERFORMANCE (CONTINUED)

Sprinkler Selection

Under-Hip Layout Option 1:

Under-Hip Layout Option FL-SA/GAP Sprinklers Only

- When utilizing this option, Model FL-SA/GAP sprinklers are used to protect the entire area between the hip rafters. This option may be used when the framing under the hip roof consists of stepdown hip trusses running perpendicular to the slope in conjunction with jack trusses near the eave.
- See Figure 12 for detailed layout criteria.

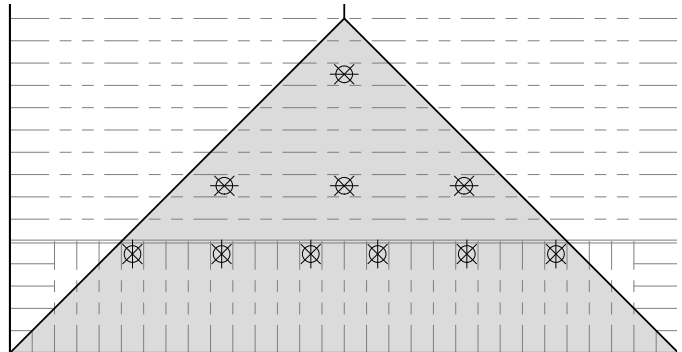

Under-Hip Layout Option 2:

Under-Hip Layout Option Using FL-SA/GAP Sprinklers or Using FL-SA/DS Sprinklers

- When the framing runs parallel to the slope of the hip, forming a 90 degree intersection at the hip rafter, either Model FL-SA/DS in accordance with Figure 13 or Model FL-SA/GAP in accordance with Figure 14 may be utilized.

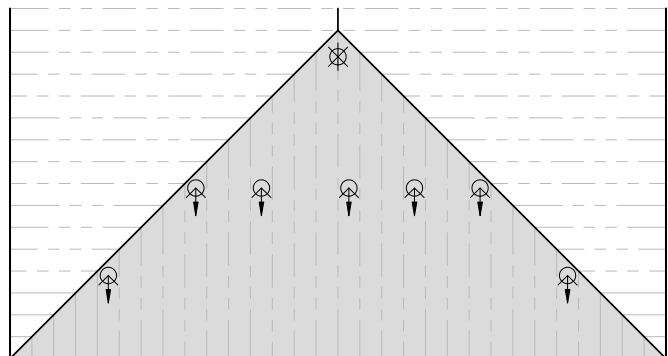
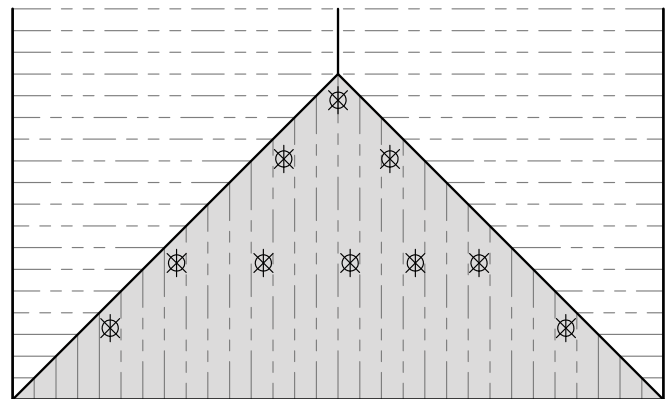

FIGURE 7: UNDER-HIP PROTECTION OPTIONS

⊗ = FL-SA/GAP

⊕ = FL-SA/DS

5.0 PERFORMANCE (CONTINUED)

Sprinkler Selection

Adjacent Hip Layout Option 1:

FL-SA/DS Sprinklers Only

- When utilizing this option, Model FL-SA/DS sprinklers are used to protect the section of the attic space adjacent to the HIP area.
- See Figure 15 for detailed layout criteria

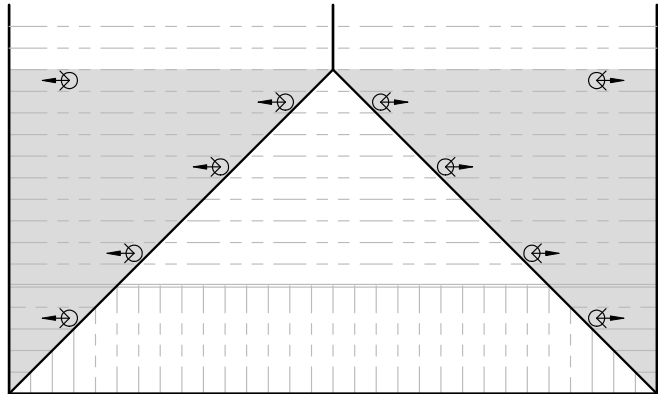

Adjacent Hip Layout Option 2:

FL-SA/GAP Sprinklers Only

- When utilizing this option, Model FL-SA/GAP sprinklers are used to protect the section of the attic space adjacent to the HIP area.
- See Figure 16 for detailed layout criteria.

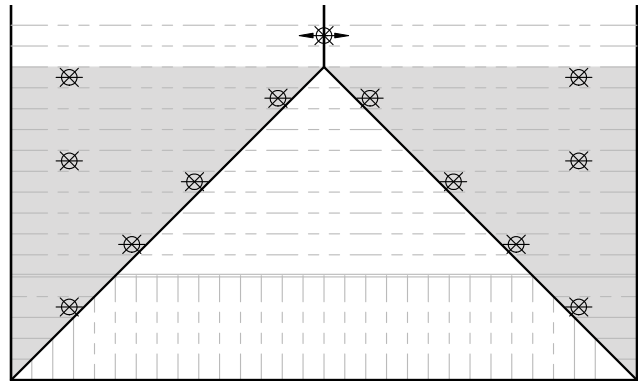

FIGURE 8: ADJACENT HIP PROTECTION OPTIONS

⊗ = FL-SA/GAP

⊙ = FL-SA/DS

5.0 PERFORMANCE (CONTINUED)

Layout Criteria – Gable

Sprinkler Model

- FL-SA/BB

Flow Rate

- ≤ 40 ft. span: 24 gpm
- >40 ft. up to and including 60 ft. span 38 gpm

Distance Between Sprinklers Along Ridge

- Minimum 4 ft.
- Maximum 6 ft.

Deflector Distance Below Ceiling

- Minimum 16 in.
- Maximum 24 in.

Lateral Maximum Distance From Peak

- 6 in.

Distance From Hip Apex Or Wall

- Maximum 3 ft.

Installation

- When installed for Peak protection, the FL-SA/BB Sprinkler has a zone of protection of 60 ft. wide (as measured horizontally) across the ridgeline. The maximum zone of protection on either side of the ridgeline is 30 ft. (as measured horizontally). The

zone of protection along the ridgeline is 6 ft. per FL-SA/BB sprinkler. (3 ft. to either side)

- When a FL-SA/BB sprinkler is installed under a horizontal Ridge, the deflector is to be positioned parallel with the floor/ceiling below. (Regardless of allowed offset from directly below ridge)
- Maximum span for FL-SA/BB sprinkler to cover is 60 ft wide attic.
- Sprinklers must be installed with the frame arms perpendicular to the trusses.
- A minimum of 6" must be kept from the sprinkler and the lateral face of any truss. (see Figure 28).
- For obstruction criteria, see Obstruction section within this data sheet.
- Minimum lateral distance from FL-SA/BB and FL-SA/GAP is 6 ft.
- Minimum lateral distance from FL-SA/BB and FL-SA/DS is 4 ft.
- When installed under a flat sloped ceiling (noncombustible insulation filled joist channels) maximum deflector to ceiling distance is measured to the bottom of the insulation.

HYDRAULIC CALCULATIONS

- See Hydraulic Design Section

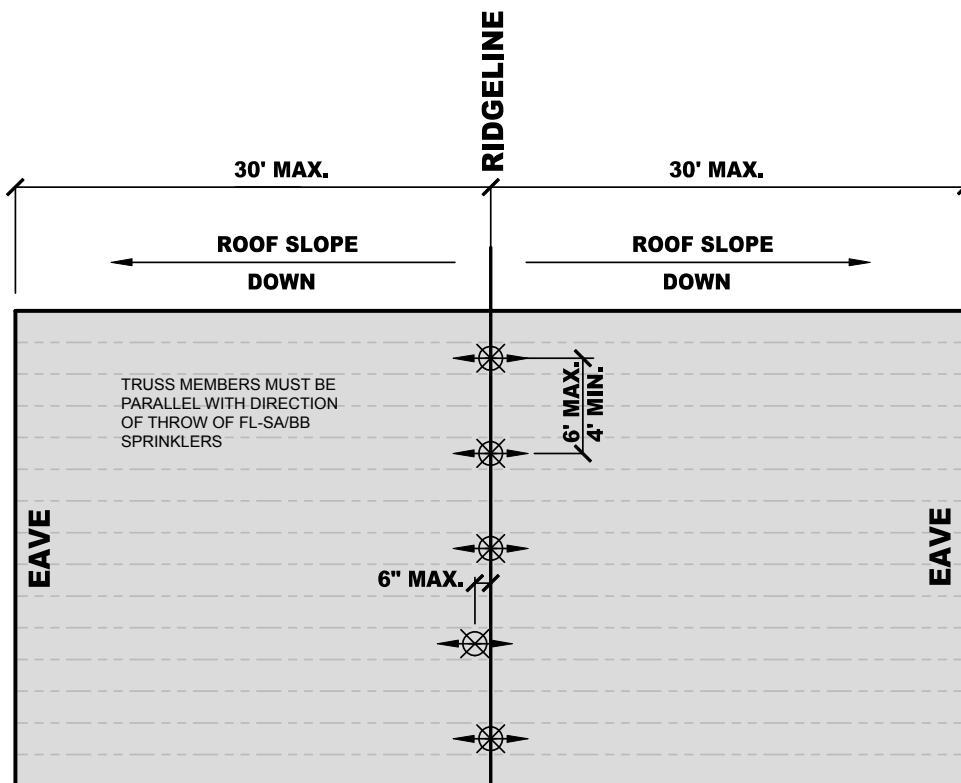

NOTE

- If a flat sloped ceiling is present utilizing non combustible insulation, the insulation must completely fill the pockets between the joists, and the insulation must be secured in place with metal wire netting or equivalent. The metal wire netting is intended to hold the insulation in place should the insulation become wetted by the operation of the sprinkler. Attic sprinklers have not been evaluated for use with spray foam insulation.

FIGURE 9: GABLE LAYOUT CRITERIA

= MODEL FL-SA/BB

5.0 PERFORMANCE (CONTINUED)

Layout Criteria – Eave

Sprinkler Model

- FL-SA/GAP

Flow Rate

- 20 gpm

Distance Between Sprinklers Perpendicular To Slope

- Minimum 6 ft
- Maximum 8 ft

Distance to Attic Eave

- Minimum 4 ft
- Maximum 12 ft

Minimum Distance From FL-SA/BB Sprinkler (Measured Along The Slope)

- Minimum 21 ft (Located in Adjacent Channel)

Deflector Distance Below Ceiling

- Install with deflector below bottom of top chord 1" minimum to 3" maximum.

Installation

- When installed for Eave protection, the FL-SA/GAP Sprinkler has a zone of protection of 12 ft. in the downslope direction to the eave (measured on the

horizontal) and 8 ft. wide (4 ft. laterally to either side of the sprinkler). There is no zone of protection allowance "upslope" of the FL-SA/GAP sprinklers when used along eaves in conjunction with the FL-SA/BB sprinklers upslope.

- Ensure that the sprinkler is installed with the deflector parallel to the sloped roof above.
- Centerline of sprinkler must be a minimum of 6" laterally from face of truss (See Figure 28).
- Must be offset at least one channel laterally from any upslope sprinkler.
- Sprinklers must be installed with the frame arms perpendicular to the roof slope.
- For obstruction criteria, see Obstruction section within this data sheet.
- When installed under a flat sloped ceiling (noncombustible insulation filled joist channels), maximum deflector to ceiling distance is the same as maximum distance below bottom of top chord. Distance to be measured to bottom of insulation.

Hydraulic Calculations

- See Hydraulic Design Section

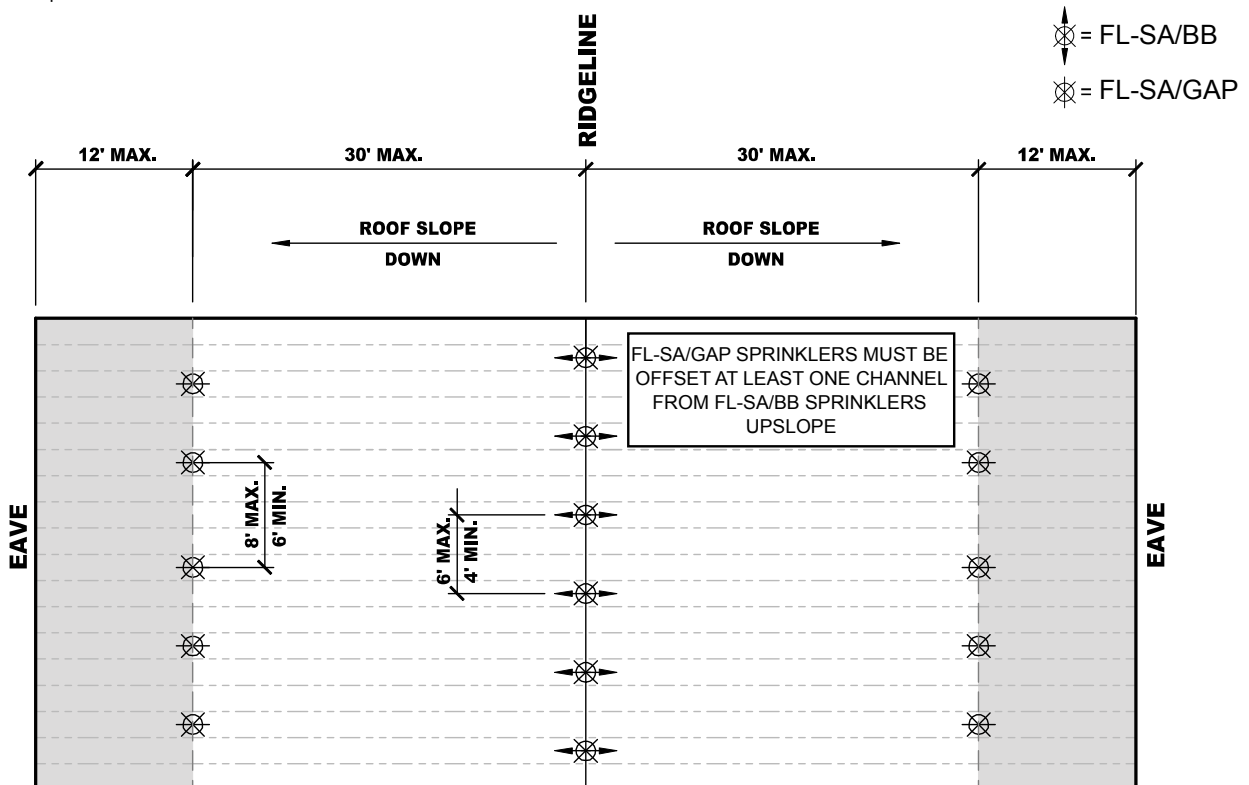

FIGURE 10: EAVE LAYOUT CRITERIA

NOTE

- If a flat sloped ceiling is present utilizing non combustible insulation, the insulation must completely fill the pockets between the joists, and the insulation must be secured in place with metal wire netting or equivalent. The metal wire netting is intended to hold the insulation in place should the insulation become wetted by the operation of the sprinkler. Attic sprinklers have not been evaluated for use with spray foam insulation.

5.0 PERFORMANCE (CONTINUED)

Layout Criteria – Single Slope

Sprinkler Model

- FL-SA/DS

Slope

- 4:12 Up to and Including 12:12

Flow Rate

- 20 gpm

Deflector Distance Below Peak (See Figure 14A)

- Minimum 16 in.
- Maximum 24 in.

Deflector Distance Below Sloping Roof Deck (See Figure 14a)

- Install with deflector below bottom of top chord to a maximum of 2 in.

Distance Between Sprinklers Perpendicular To The Slope

- Minimum 4 ft.
- Maximum 8 ft.

Maximum Allowed Sprinkler Throw (Measured Horizontally)

- Downslope – 16 ft.

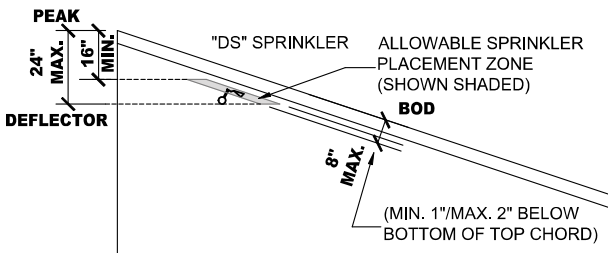

FIGURE 11A: SECTION VIEW DS SPRINKLER & DEFLECTOR PLACEMENT AT PEAK

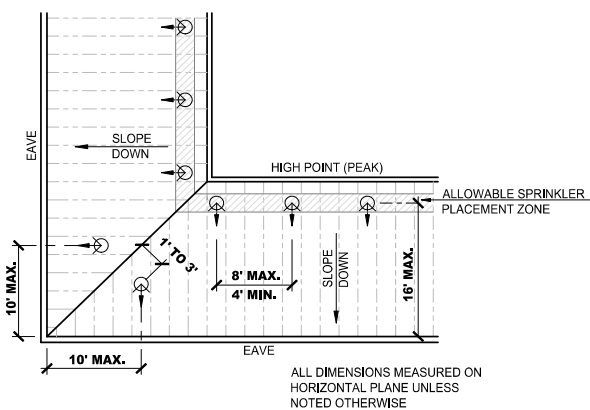

FIGURE 11B: 1 ROW DS SPRINKLER (HIP SHOWN AT CORNER)

Minimum Distance Between Sprinklers Downslope of The FL-SA/DS (Throw Direction)

- 15 ft. (as measured on the slope) INSTALLATION
- Ensure that the sprinkler deflector is installed with the deflector parallel to the sloped roof above.
- Centerline of sprinkler must be a minimum of 6" laterally from face of truss. See Figure 28.
- When two rows of FL-SA/DS sprinklers are utilized, the adjacent rows of sprinklers must be offset at least one channel laterally from each other.
- Sprinklers must be installed with the frame arms perpendicular to the roof slope. See Figure 35.
- For obstruction criteria, see Obstruction section within this data sheet.
- When installed under a flat sloped ceiling (noncombustible insulation filled joist channels), maximum deflector to ceiling distance is the same as maximum distance below bottom of top chord. Distance to be measured to bottom of Insulation.

Hydraulic Calculations

- See Hydraulic Design Section

NOTE

- If a flat sloped ceiling is present utilizing non combustible insulation, the insulation must completely fill the pockets between the joists, and the insulation must be secured in place with metal wire netting or equivalent. The metal wire netting is intended to hold the insulation in place should the insulation become wetted by the operation of the sprinkler. Attic sprinklers have not been evaluated for use with spray foam insulation.

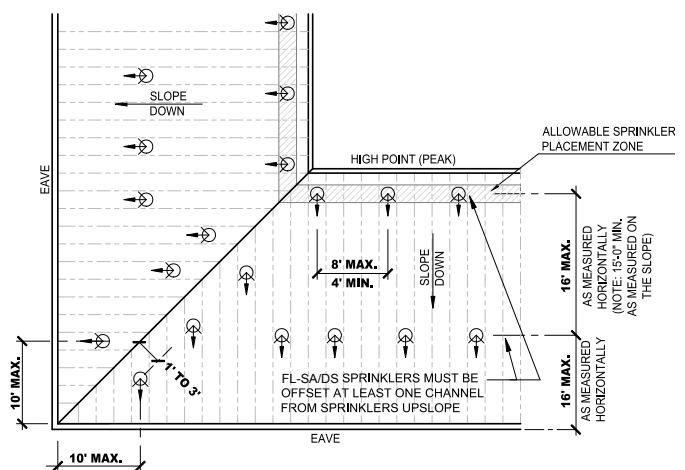

FIGURE 11C: 2 ROW DS SPRINKLER (HIP SHOWN AT CORNER)

FIGURE 11: SINGLE SLOPE SPACING CRITERIA

5.0 PERFORMANCE (CONTINUED)

Layout Criteria – Under-Hip Sprinkler: Hip Truss/Jack Truss Construction

Sprinkler Model

- FL-SA/GAP

Flow Rate

- 20 gpm

Distance Between Sprinklers

First Row From Eave (Measured Horizontally)

- Minimum 6 ft
- Maximum 8 ft

Distance Between Sprinklers

All Other Rows Upslope (Measured Horizontally)

- Minimum 6 ft
- Maximum 12 ft

Distance From Eave To First Row

(measured horizontally)

- Minimum 5 ft
- Maximum 12 ft

Distance Between Rows (Measured Horizontally)

- Minimum 6 ft
- Maximum 10 ft

Deflector Distance Below Ceiling

- Install with deflector below bottom of top chord 1" minimum to 3" maximum.

Sprinkler at Apex

- A FL-SA/GAP Sprinkler must be installed between 1 ft. to 5 ft. down from the intersection of the ridgeline and hip lines (Apex)

Sprinklers Adjacent to Hip Line

- All FL-SA/GAP Sprinklers directly adjacent to hip line shall be 1 ft. to 3 ft. from hip line (as measured perpendicular to hip line)

Installation

- Ensure that the sprinkler is installed with the deflector parallel to the sloped roof above.
- Sprinklers must be installed with the frame arms perpendicular to the roof slope (see Figure 35).
- When installed under a flat sloped ceiling (noncombustible insulation filled joist channels), maximum deflector to ceiling distance is the same as maximum distance below bottom of top chord. Distance to be measured to bottom of Insulation.

Hydraulic Calculations

- See Hydraulic Design Section

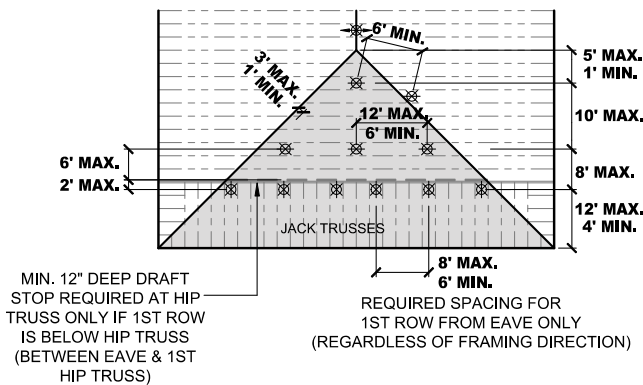

FIGURE 12A: HIP LAYOUT CRITERIA WHEN FIRST ROW OF SPRINKLERS PLACED "WITHIN" JACK TRUSSES

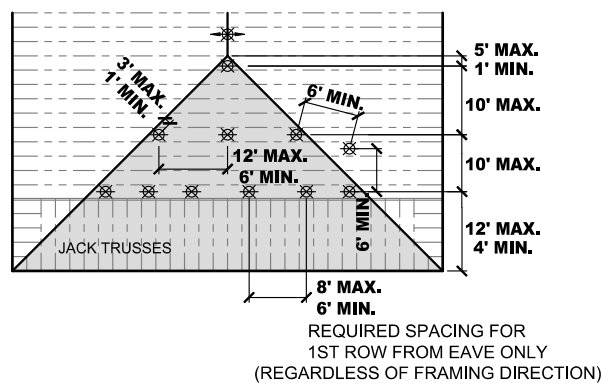

FIGURE 12B: HIP LAYOUT CRITERIA WHEN FIRST ROW OF SPRINKLERS PLACED "BEYOND" JACK TRUSSES

FIGURE 12: HIP LAYOUT CRITERIA – HIP TRUSS/JACK TRUSS CONSTRUCTION

NOTE

- If a flat sloped ceiling is present utilizing non combustible insulation, the insulation must completely fill the pockets between the joists, and the insulation must be secured in place with metal wire netting or equivalent. The metal wire netting is intended to hold the insulation in place should the insulation become wetted by the operation of the sprinkler. Attic sprinklers have not been evaluated for use with spray foam insulation.

5.0 PERFORMANCE (CONTINUED)

Sprinkler Layout – Under-Hip Criteria: Framing Members Parallel To Roof Slope

Sprinkler Model

- FL-SA/DS (FL-SA/GAP @ apex)

Flow Rate

- 20 gpm

Distance Between Sprinklers

- Minimum 6 ft
- Maximum 8 ft

Distance From Eave to First Row (measured horizontally)

- Minimum 5 ft
- Maximum 20 ft

Deflector Distance Below Ceiling

- Install with deflector below bottom of top chord 1" minimum to 4" maximum.

Sprinkler at Apex

- A FL-SA/GAP Sprinkler must be installed between 1 ft. to 5 ft. down from the intersection of the ridgeline and hip lines (Apex)

Sprinklers Adjacent To Hip Line

- All FL-SA/GAP Sprinklers directly adjacent to hip line shall be 1 ft. to 3 ft. from hip line (as measured perpendicular to hip line)

Installation

- Ensure that the sprinkler is installed with the deflector parallel to the sloped roof above Sprinklers must be installed with the frame arms perpendicular to the roof slope (see Figure 4).
- For obstruction criteria, see Obstruction section within this data sheet.
- When installed under a flat sloped ceiling (noncombustible insulation filled joist channels), maximum deflector to ceiling distance is the same as maximum distance below bottom of top chord. Distance to be measured to bottom of Insulation.

Hydraulic Calculations

- See Hydraulic Design Section

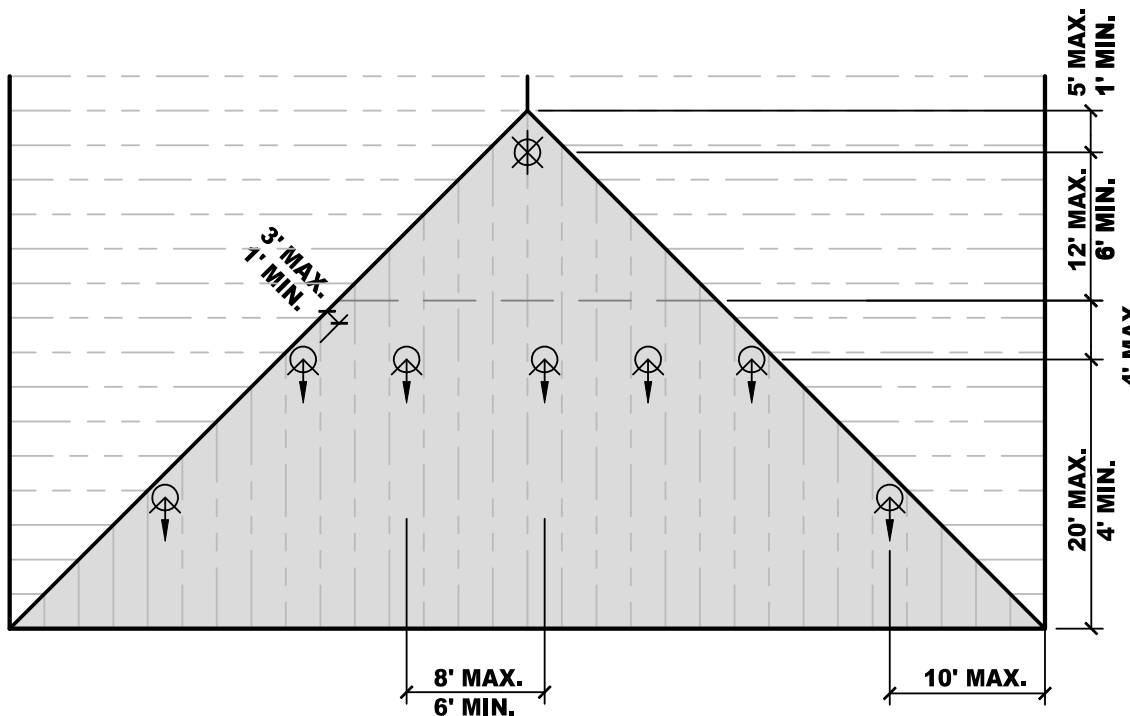

TYPICAL BELOW ENTIRE HIP ROOF WHEN FRAMING IS PARALLEL TO ROOF SLOPE

FIGURE 13: UNDER-HIP LAYOUT CRITERIA FRAMING MEMBERS PARALLEL TO ROOF SLOPE USING FL-SA/DS

NOTE

- If a flat sloped ceiling is present utilizing non combustible insulation, the insulation must completely fill the pockets between the joists, and the insulation must be secured in place with metal wire netting or equivalent. The metal wire netting is intended to hold the insulation in place should the insulation become wetted by the operation of the sprinkler. Attic sprinklers have not been evaluated for use with spray foam insulation.

 = MODEL FL-SA/DS

5.0 PERFORMANCE (CONTINUED)

Sprinkler Layout – Under-Hip Criteria: Framing Members Parallel To Roof Slope

Sprinkler Model

- FL-SA/GAP

Flow Rate

- 20 gpm

Distance From Eave to First Row (measured horizontally)

- Minimum 5 ft
- Maximum 12 ft

Maximum Distance Between Sprinklers

- See Figure 12

Deflector Distance Below Ceiling

- Install with deflector below bottom of top chord 1" minimum to 3" maximum

Sprinkler at Apex

- A FL-SA/GAP Sprinkler must be installed between 1 ft. to 5 ft. down from the intersection of the ridgeline and hip lines (Apex)

Sprinklers Adjacent To Hip Line

- All FL-SA/GAP Sprinklers directly adjacent to hip line shall be 1 ft. to 3 ft. from hip line (as measured perpendicular to hip line) Installation
- Ensure that the sprinkler is installed with the deflector parallel to the sloped roof above Sprinklers must be installed with the frame arms perpendicular to the roof slope.
- For obstruction criteria, see Obstruction section within this data sheet.

Hydraulic Calculations

- See Hydraulic Design Section

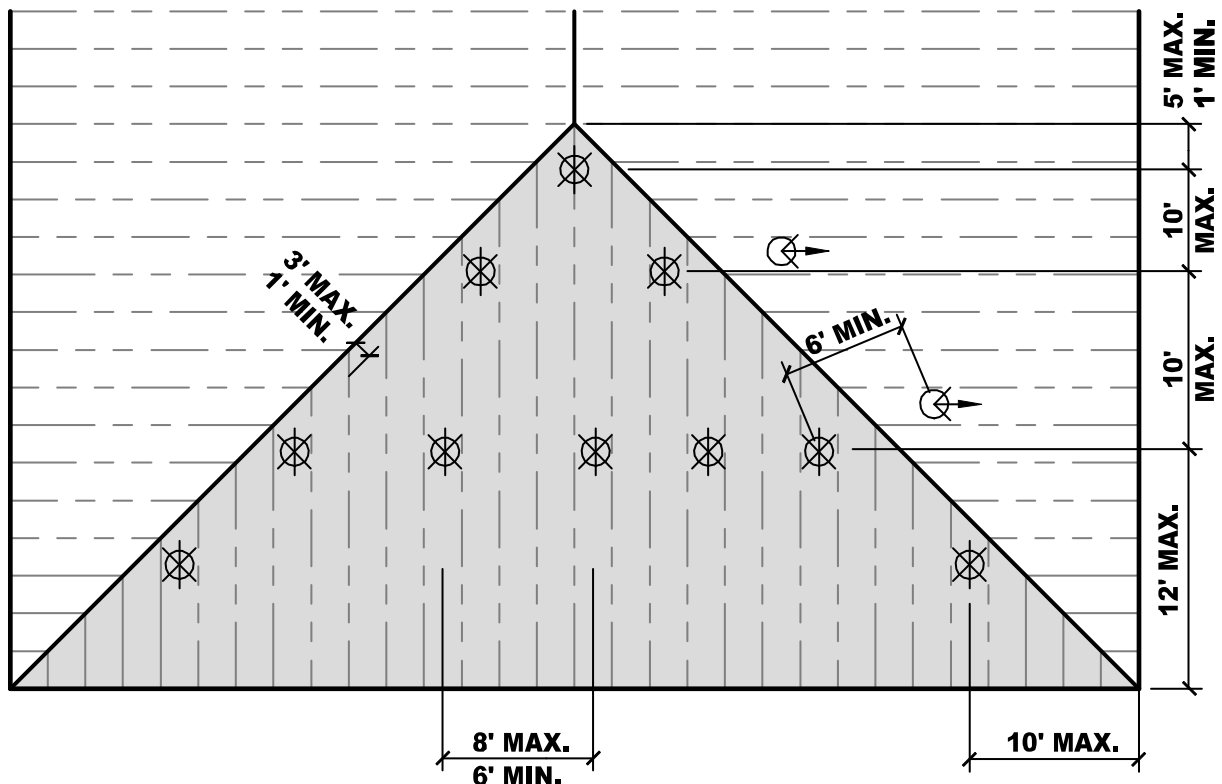

TYPICAL BELOW ENTIRE HIP ROOF WHEN FRAMING IS PARALLEL TO ROOF SLOPE

FIGURE 14: UNDER-HIP LAYOUT CRITERIA FRAMING MEMBERS PARALLEL TO ROOF SLOPE USING FL-SA/GAP

NOTE

- If a flat sloped ceiling is present utilizing non combustible insulation, the insulation must completely fill the pockets between the joists, and the insulation must be secured in place with metal wire netting or equivalent. The metal wire netting is intended to hold the insulation in place should the insulation become wetted by the operation of the sprinkler. Attic sprinklers have not been evaluated for use with spray foam insulation.

⊗ = FL-SA/GAP

5.0 PERFORMANCE (CONTINUED)

Sprinkler Layout – Adjacent Hip Criteria

Sprinkler Model

FL-SA/DS

Flow Rate

- 20 gpm

Distance Between Sprinklers

- Minimum 6 ft
- Maximum 8 ft

Distance From Eave To First Row (measured horizontally)

- Minimum 5 ft
- Maximum 20 ft

Deflector Distance Below Ceiling

- Install with deflector below bottom of top chord 1" minimum to 4" maximum.

Sprinklers Adjacent To Hip Line

- All FL-SA/GAP Sprinklers directly adjacent to hip line shall be 1 ft. to 3 ft. from hip line (as measured perpendicular to hip line)

Installation

- Ensure that the sprinkler is installed with the deflector parallel to the sloped roof above
- Sprinklers must be installed with the frame arms perpendicular to the roof slope (see Figure 35).
- For obstruction criteria, see Obstruction section within this data sheet.

Hydraulic Calculations

- See Hydraulic Design Section

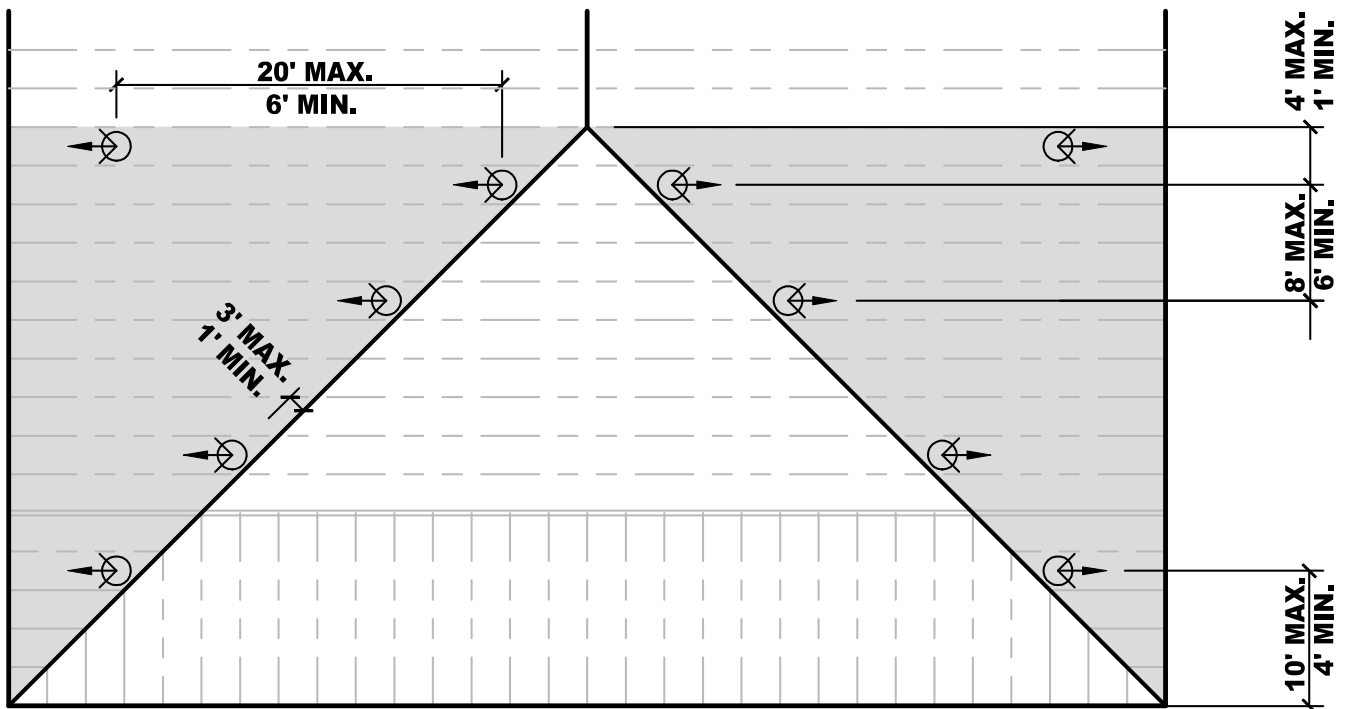



FIGURE 15: ADJACENT HIP LAYOUT CRITERIA USING FL-SA/DS SPRINKLERS

NOTE

- If a flat sloped ceiling is present utilizing non combustible insulation, the insulation must completely fill the pockets between the joists, and the insulation must be secured in place with metal wire netting or equivalent. The metal wire netting is intended to hold the insulation in place should the insulation become wetted by the operation of the sprinkler. Attic sprinklers have not been evaluated for use with spray foam insulation.

 = MODEL FL-SA/DS

5.0 PERFORMANCE (CONTINUED)

Adjacent Hip Sprinkler Layout Criteria

Sprinkler Model

FL-SA/DS

Flow Rate

- 20 gpm

Distance Between Sprinklers

- Minimum 6 ft
- Maximum 8 ft

Distance From Eave To First Row (measured horizontally)

- Minimum 5 ft
- Maximum 20 ft

Deflector Distance Below Ceiling

- Install with deflector below bottom of top chord 1" minimum to 3" maximum.

Sprinklers Adjacent To Hip Line

- All FL-SA/GAP Sprinklers directly adjacent to hip line shall be 1 ft. to 3 ft. from hip line (as measured perpendicular to hip line)

Installation

- Ensure that the sprinkler is installed with the deflector parallel to the sloped roof above
- Sprinklers must be installed with the frame arms perpendicular to the roof slope (see Figure 35).
- For obstruction criteria, see Obstruction section within this data sheet.

Hydraulic Calculations

- See Hydraulic Design Section

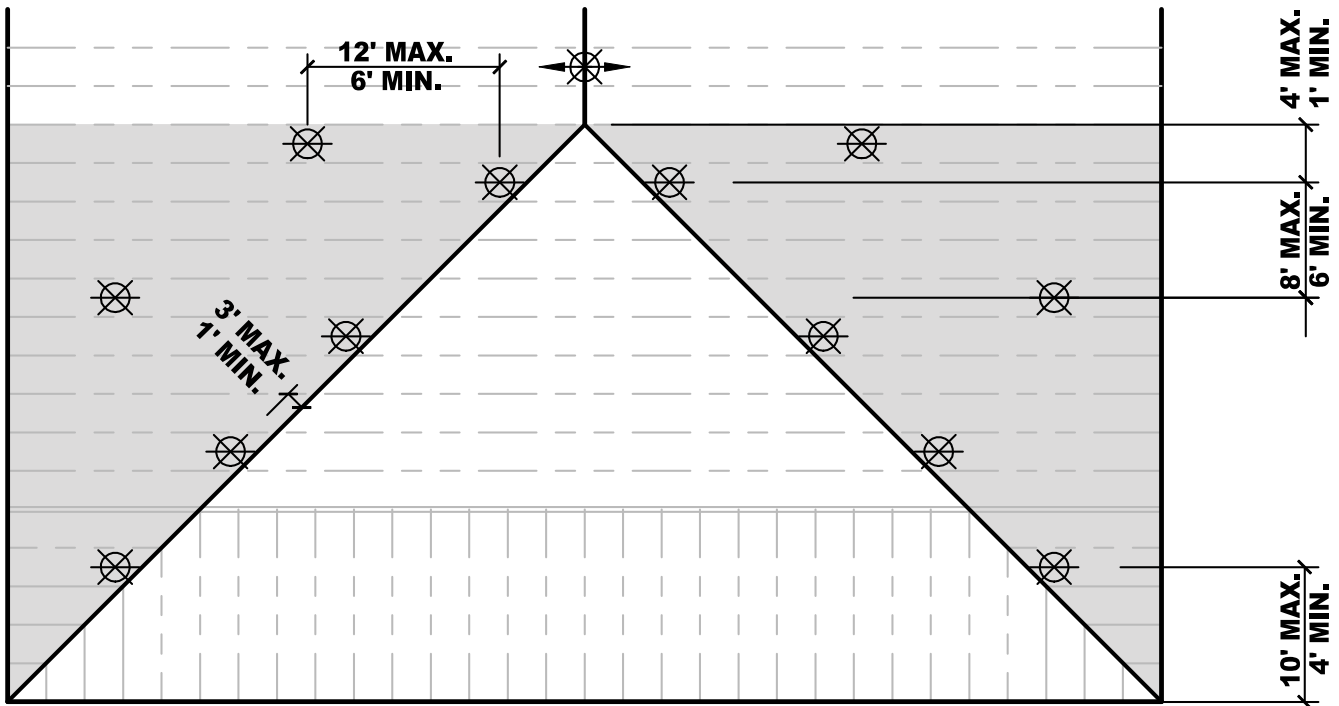

FIGURE 16: ADJACENT HIP LAYOUT CRITERIA USING FL-SA/GAP SPRINKLERS

NOTE

- If a flat sloped ceiling is present utilizing non combustible insulation, the insulation must completely fill the pockets between the joists, and the insulation must be secured in place with metal wire netting or equivalent. The metal wire netting is intended to hold the insulation in place should the insulation become wetted by the operation of the sprinkler. Attic sprinklers have not been evaluated for use with spray foam insulation.

⊗ = FL-SA/GAP

5.0 PERFORMANCE (CONTINUED)

Dormer Protection Criteria

Dormers Built Entirely Over (on top) of Main Roof Sheathing – 4 Sprinklers or Less

- FL-SA/BB, FL-SA/GAP, and FL-SA/DS sprinklers allowed (CPVC allowance applies for wet systems only)
- Standard Spray Sprinklers allowed

Dormers Built Entirely Over (on top) of Main Roof Sheathing – More than 4 Sprinklers

- FL-SA/BB, FL-SA/GAP, and FL-SA/DS Sprinklers allowed- Protection scheme utilized shall be in accordance with this document
- Standard Spray Sprinklers allowed for any slope

Dormers Open to Attic Space Below – 4 Sprinklers or Less

- FL-SA/BB, FL-SA/GAP, and FL-SA/DS Sprinklers allowed (CPVC allowance applies for wet systems only)
- Standard Spray Sprinklers allowed

Dormers Open to Attic Space Below – More than 4 Sprinklers

- FL-SA/BB, FL-SA/GAP, and FL-SA/DS Sprinklers allowed. Protection scheme utilized, shall be in accordance with this document
- Standard Spray Sprinklers allowed but required to calculate Attic in accordance with NFPA 13 (i.e. 2535 sq. ft. for Dry Systems)

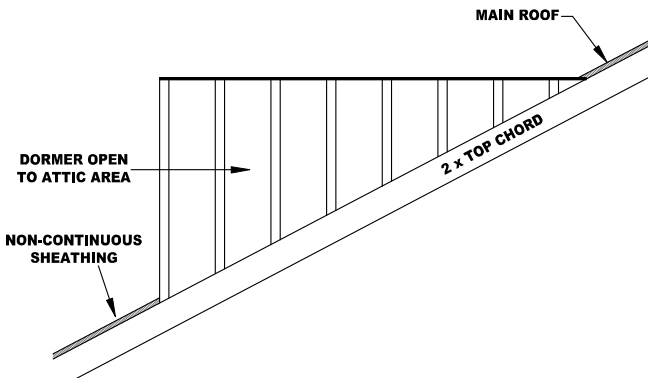

FIGURE 17A: DORMER OPEN TO ATTIC SPACE

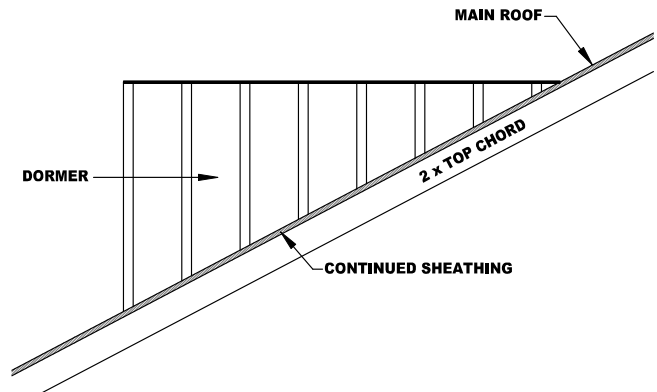

FIGURE 17B: DORMER ENTIRELY OVER MAIN ROOF SHEATHING

FIGURE 17: DORMERS SECTION VIEW

NOTE

- If a flat sloped ceiling is present utilizing non combustible insulation, the insulation must completely fill the pockets between the joists, and the insulation must be secured in place with metal wire netting or equivalent. The metal wire netting is intended to hold the insulation in place should the insulation become wetted by the operation of the sprinkler. Attic sprinklers have not been evaluated for use with spray foam insulation.

5.0 PERFORMANCE (CONTINUED)

Hydraulic Design

The Specific Application Attic protection scheme shall be hydraulically calculated in accordance with the following guidelines. These calculation guidelines are applicable only to the special Attic Protection scheme utilizing FL-SA/BB, FL-SA/GAP, and FL-SA/DS sprinklers. These requirements are based on special full scale fire testing and in no way should be utilized when designing other than these specially Listed and tested sprinklers for use in sloped combustible attic structures. As with Hydraulic Calculations performed in accordance with NFPA 13, multiple areas of piping may need to be investigated and multiple calculations performed should it not be readily obvious of the hydraulically most demanding area due to non-typical pipe layout.

- FL-SA/BB Minimum Sprinkler Demand- The minimum required flow and pressure is shown below in Table 2. The minimum sprinkler demand is dependent on the span that the FL-SA/BB is covering.
- FL-SA/GAP and FL-SA/DS Minimum Sprinkler Demand- The minimum required sprinkler demand for the FL-SA/GAP, and FL-SA/DS is always 20 gpm and 12.8 psi.

TABLE 2: HYDRAULIC CRITERIA

Sprinkler Model	Sin	K Factor	Span	Roof Pitch	Minimum Flow Rate gpm	Minimum Pressure psi
BB46	V8122	8.0	>40 ft to ≤60 ft	4:12 to less than 7:12	38	22.6
BB46	V8122	8.0	≤40 ft	4:12 to less than 7:12	24	9
BB79	V8123	8.0	>40 ft to ≤60 ft	7:12 to less than 10:12	38	22.6
BB79	V8123	8.0	≤40 ft	7:12 to less than 10:12	24	9
BB1012	V8124	8.0	>40 ft to ≤60 ft	10:12 to 12:12	38	22.6
BB1012	V8124	8.0	≤40 ft	10:12 to 12:12	24	9
GAP	V5623	5.6	NA	SEE LAYOUT CRITERIA	20	12.8
DS	V5621	5.6	NA	SEE LAYOUT CRITERIA	20	12.8

5.0 PERFORMANCE (CONTINUED)

Hydraulic Criteria FL-SA/BB Only or FL-SA/BB with FL-SA/GAP and/or FL-SA/DS for Wet and Dry Systems

Perform the following calculations:

Calculation #1:

- Calculate the most hydraulically demanding sprinklers consisting of 5 FL-SA/BB and up to a maximum of 2 FL-SA/ GAP or FL-SA/DS sprinklers (if applicable) for wet systems or 7 FL-SA/BB and up to a maximum of 2 FL-SA/ GAP or FL-SA/DS sprinklers (if applicable) for dry systems. See Figure 18 for wet systems and Figure 19 for dry systems. See Table 2 for minimum flow and pressure requirements for the specific span, pitch and sprinkler type.

Calculation #2:

- If a HIP is present, find the appropriate Figure in the Hydraulic Criteria Section and perform the required calculations.

NOTE

- If additional sprinklers are required beyond an obstruction, calculate up to 2 additional sprinklers beyond the obstruction.

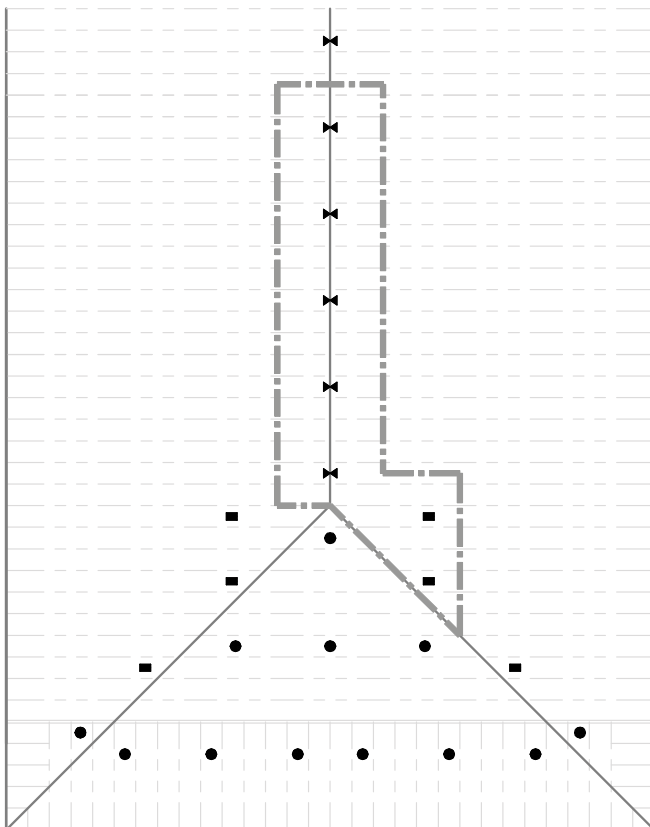

HIP may or may not be present

FIGURE 18:

HYDRAULIC CRITERIA FL-SA/BB AND/OR FL-SA/GAP AND/OR FL-SA/DS WET SYSTEM

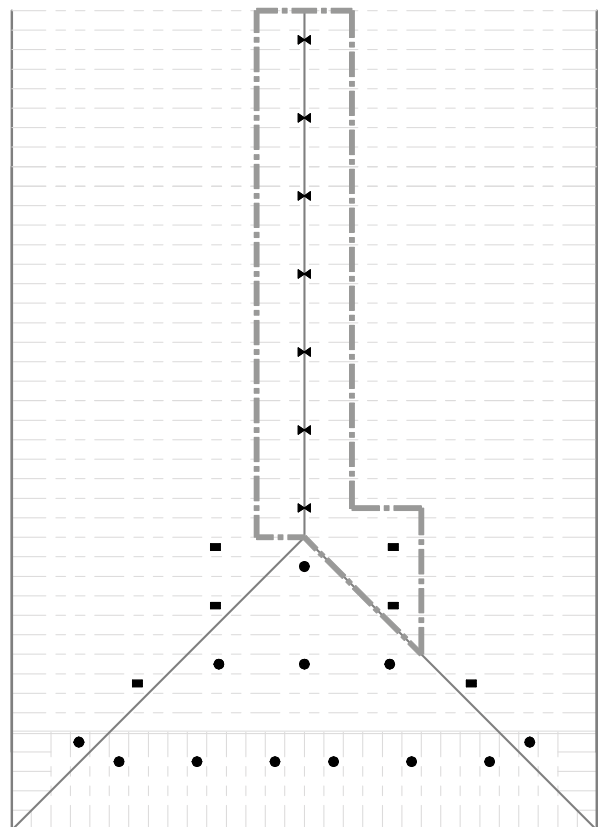

HIP may or may not be present

FIGURE 19:

HYDRAULIC CRITERIA FL-SA/BB AND/OR FL-SA/GAP AND/OR FL-SA/DS DRY SYSTEMS

NOTE

- If a flat sloped ceiling is present utilizing non combustible insulation, the insulation must completely fill the pockets between the joists, and the insulation must be secured in place with metal wire netting or equivalent. The metal wire netting is intended to hold the insulation in place should the insulation become wetted by the operation of the sprinkler. Attic sprinklers have not been evaluated for use with spray foam insulation.

5.0 PERFORMANCE (CONTINUED)

Hydraulic Criteria For Hip With Hip Truss/Jack Truss Construction – Wet System Only

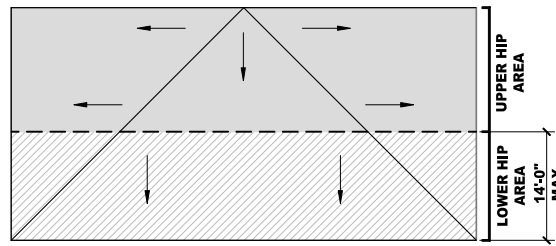

When a Hip is included in the design of the attic, there are three calculations required. One calculation for the “Ridge/Hip Transition” area. The second and third calculations determine the pipe sizing for the Hip area itself. For the purposes of these hydraulic calculations the Hip is broken into two areas; the “Lower Hip” area; and the “Upper Hip” area. See above Figure.

Hip Calculation (Hip Truss/Jack Truss Construction) – Wet System

Calculation #1 – Lower Hip Area

- Calculate up to the 7 most demanding contiguous sprinklers along the eave. This may include sprinklers on both sides of the hip line as shown. See Figure 20A and Figure 20B.
- Minimum sprinkler flow rate is 20 gpm per sprinkler.

Calculation #2 – Upper Hip Area

If there are 4 sprinklers or less in the shaded area (Figure 20A):

- Calculate up to the 7 most demanding contiguous sprinklers in the "Upper Hip" area. This may include sprinklers on both sides of the hip line as shown.
- Minimum sprinkler flow rate is 20 gpm per sprinkler.

If there are more than 4 sprinklers in the shaded area (Figure 20B):

- Calculate the hydraulically most demanding 75% of the total number of sprinklers located within the "Upper Hip" area, rounding up to the nearest sprinkler. (Minimum number of sprinklers to be calculated is 7)
- Minimum sprinkler flow rate is 20 gpm per sprinkler.
 - Example shown in FIGURE 20B results in 12 sprinklers to be calculated. (18 x 0.75 = 12)

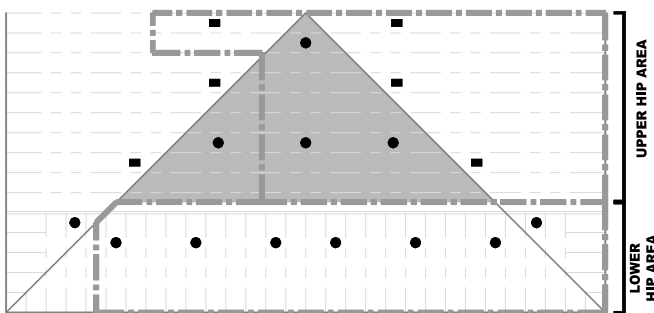

FIGURE 20A

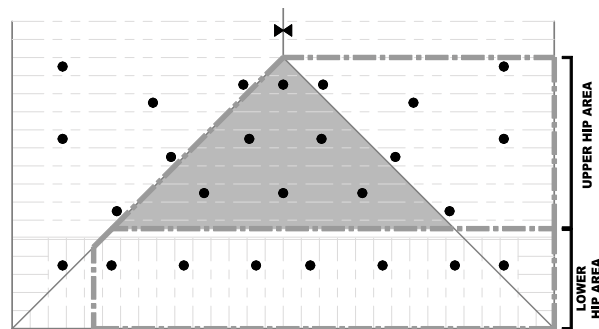

FIGURE 20B

FIGURE 20: HYDRAULIC CALCULATIONS REQUIRED FOR HIP – WET SYSTEM (HIP TRUSS/JACK TRUSS CONSTRUCTION)

- = FL-SA/GAP
- = FL-SA/DS

5.0 PERFORMANCE (CONTINUED)

Hydraulic Criteria For Hip With Hip Truss/Jack Truss Construction – Dry System Only

Calculation #1 – Lower Hip Area

- Calculate the 8 most demanding contiguous sprinklers along the eave. This may include sprinklers on both sides of the hip line as shown. See Figure 21A.
- Minimum sprinkler flow rate is 20 gpm per sprinkler.

Calculation #2 – Upper Hip Area

If there are 4 sprinklers or less in the shaded area (Figure 21A):

- Calculate up to the 8 most demanding contiguous sprinklers in the "Upper Hip" area. This may include sprinklers on both sides of the hip line as shown. See Figure 18B.
- Minimum sprinkler flow rate is 20 gpm per sprinkler.

If there are more than 4 sprinklers in the shaded area (Figure 21B):

- Calculate all sprinklers in the "Upper Hip" area.
- Minimum sprinkler flow rate is 20 gpm per sprinkler.

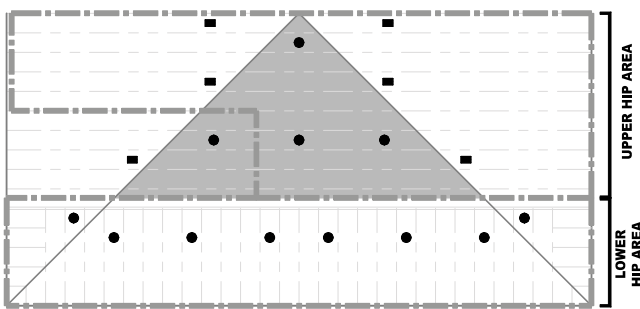

FIGURE 21A

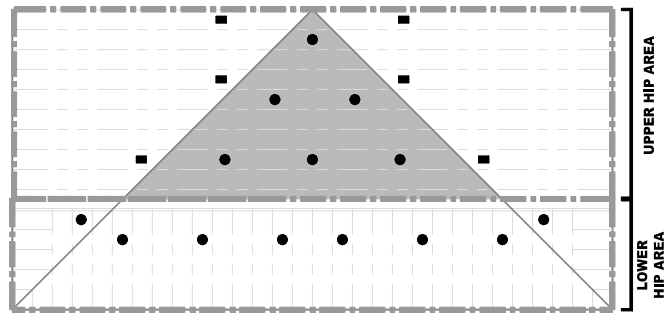

FIGURE 21B

- = FL-SA/GAP
- = FL-SA/DS

FIGURE 21: HYDRAULIC CALCULATIONS REQUIRED FOR HIP – DRY SYSTEM (HIP TRUSS/JACK TRUSS CONSTRUCTION)

(Examples shown in these figures are for reference only. Actual sprinklers selected based on piping configuration which results in the most demanding hydraulic demand.)

5.0 PERFORMANCE (CONTINUED)

Hip Calculation FL-SA/GAP Sprinklers (Framing Members Parallel to Roof Slope) – Wet and Dry System

Calculation #1 – Hip Area

- Calculate all sprinklers within the hip area shown shaded. See Figure 22.
- Minimum sprinkler flow is 20 gpm per sprinkler.

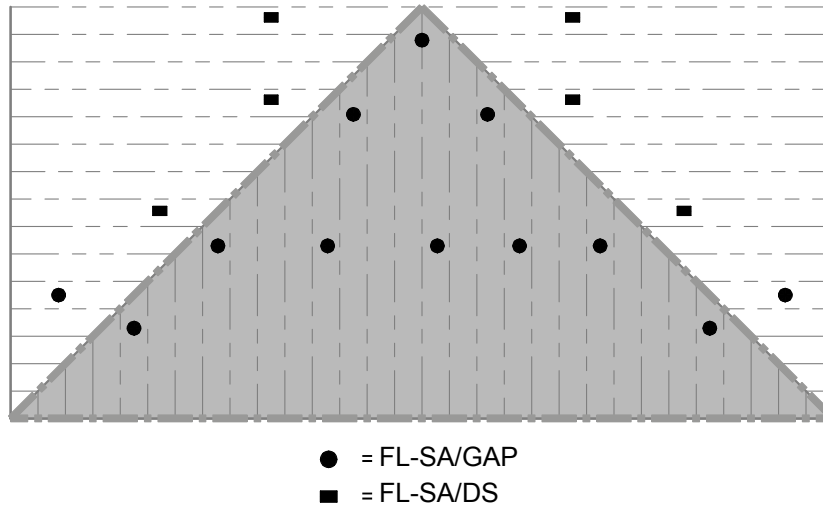

FIGURE 22: HYDRAULIC CALCULATIONS REQUIRED FOR RE @ HIP (FRAMING MEMBERS PARALLEL TO SLOPE)

Hip Calculation FL-SA/DS Sprinklers (Framing Members Parallel to Roof Slope) – Wet and Dry System

Calculation #1 – Hip Area

- Calculate all sprinklers within the hip area shown shaded. See Figure 23.
- Minimum sprinkler flow is 20 gpm per sprinkler.

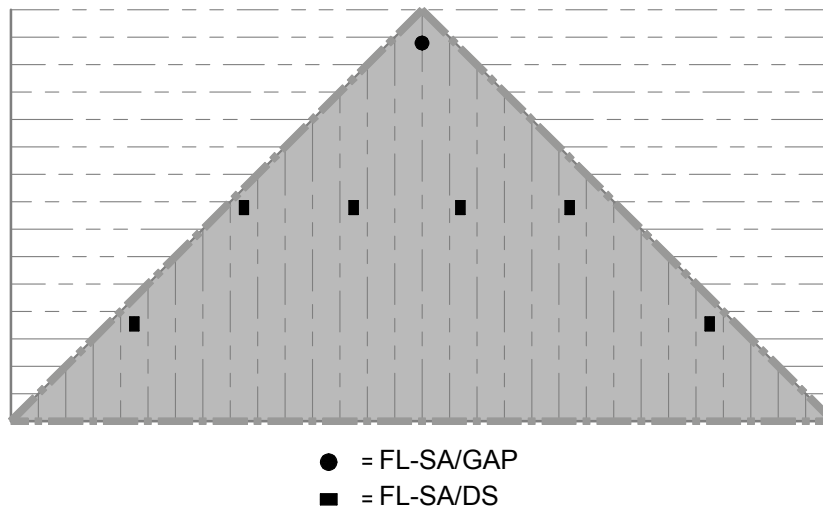

FIGURE 23: HYDRAULIC CALCULATIONS REQUIRED FOR DS @ HIP (FRAMING MEMBERS PARALLEL TO SLOPE)

5.0 PERFORMANCE (CONTINUED)

Hydraulic Criteria for Single Slope With FL-SA/DS Sprinklers Wet System Only

When a single slope roof area exists, the following calculation procedures shall be followed to size piping to the sprinklers protecting this area. NOTE: Single Slopes (with vertical shear walls) result in different fire dynamics than might be seen with gable and/or hip roof construction.

1 Row Protection

- Calculate the most hydraulically demanding 5 contiguous DS sprinklers. See Figure 24A.
- Minimum sprinkler flow is 20 gpm per sprinkler.

2 Row Protection

The following 2 sets of calculations shall be performed:

- Calculation #1: Calculate the most hydraulically demanding 5 contiguous sprinklers consisting of 3 at the high point and 2 on the adjacent slope. See Figure 24B.
- Calculation #2: Calculate the most hydraulically demanding 5 contiguous sprinklers along the high point. See Figure 24C.
- Minimum sprinkler flow is 20 gpm per sprinkler.

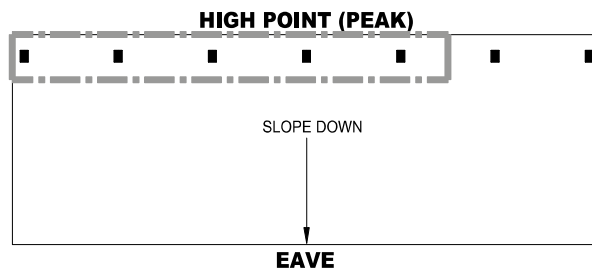

FIGURE 24A
1 ROW PROTECTION CALCULATION

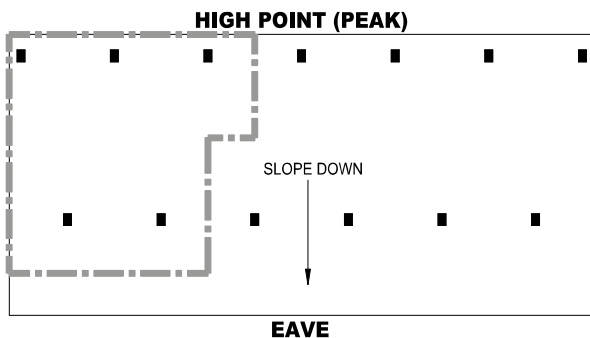
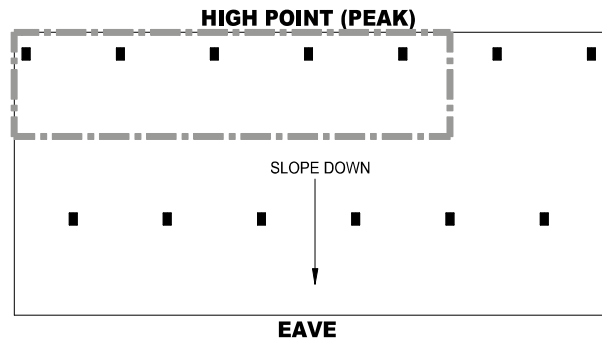

FIGURE 24B
2 ROW PROTECTION CALCULATION #1



FFIGURE 24C
2 ROW PROTECTION CALCULATION #2

FIGURE 24: HYDRAULIC CALCULATIONS REQUIRED FOR WET SYSTEM SINGLE SLOPE DESIGN

5.0 PERFORMANCE (CONTINUED)

Hydraulic Criteria for Single Slope with FL-SA/DS Sprinklers Dry System Only

When a single slope roof area exists, the following calculation procedures shall be followed to size piping to the sprinklers protecting this area. NOTE: Single Slopes (with vertical shear walls) result in different fire dynamics than might be seen with gable and/or hip roof construction.

1 Row Protection

- Calculate the most hydraulically demanding 7 contiguous DS sprinklers. See Figure 25A.
- Minimum sprinkler flow is 20 gpm per sprinkler.

2 Row Protection

The following 2 sets of calculations shall be performed:

- Calculation #1: Calculate the 7 most hydraulically demanding contiguous DS sprinklers located along the high point (peak). See Figure 25B.
- Calculation #2: Calculate the 7 most hydraulically contiguous DS sprinklers consisting of 5 DS at the high point (peak) and 2 DS sprinklers on the adjacent downslope branchline. See Figure 25C.
- Minimum sprinkler flow is 20 gpm per sprinkler.

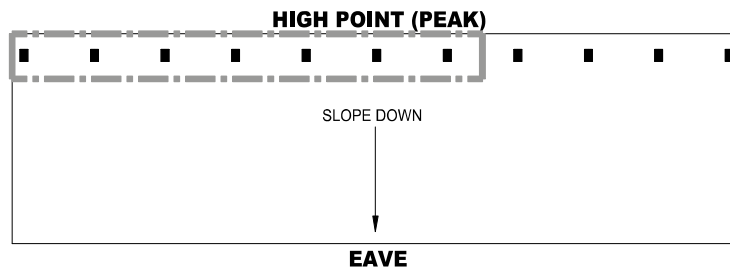

FIGURE 25A
1 ROW PROTECTION CALCULATION

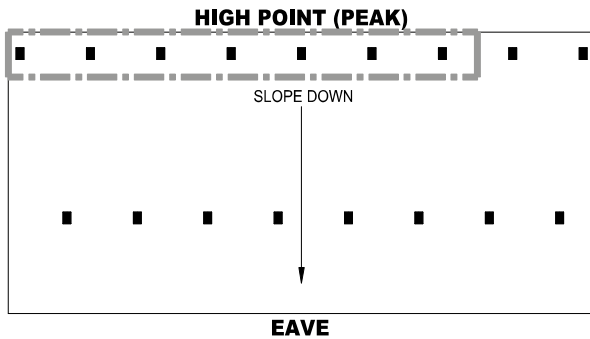
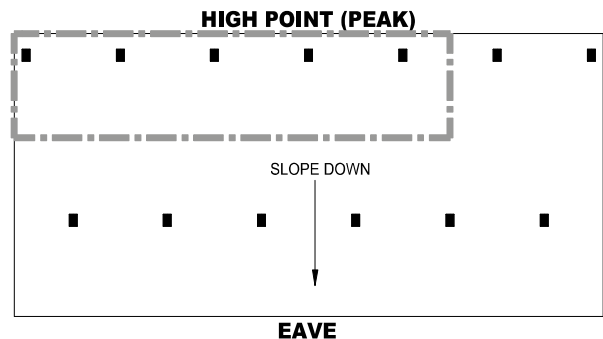

FIGURE 25B
2 ROW PROTECTION CALCULATION #1



FFIGURE 25C
2 ROW PROTECTION CALCULATION #2

FIGURE 25: HYDRAULIC CALCULATIONS REQUIRED FOR DRY SYSTEM SINGLE SLOPE DESIGN

5.0 PERFORMANCE (CONTINUED)

Hydraulic Criteria for Single Slope with Hip Wet System Only

1 Row Protection

- Calculate the 5 most hydraulically demanding contiguous DS sprinklers located along the high point plus the 2 most demanding sprinklers along the hip line. See Figure 26A.
- Minimum sprinkler flow is 20 gpm per sprinkler.

2 Row Protection

The following 3 sets of calculations shall be performed:

- Calculation #1: Calculate the 3 most hydraulically demanding contiguous DS sprinklers located along the high point (peak) plus the 2 most demanding sprinklers along the hip line. See Figure 26B.
- Calculation #2: Calculate the most hydraulically demanding 5 contiguous sprinklers along the high point. See Figure 26C.
- Calculation #3: Calculate all sprinklers within the shaded corner Hip area as shown. See Figure 26D.
- Minimum sprinkler flow is 20 gpm per sprinkler.

NOTE

- The "plus 2" most demanding sprinklers along the hip line may vary from that shown in the figures depending on actual piping. Designer may need to investigate multiple options to determine the 2 most demanding sprinklers to incorporate into the calculations.

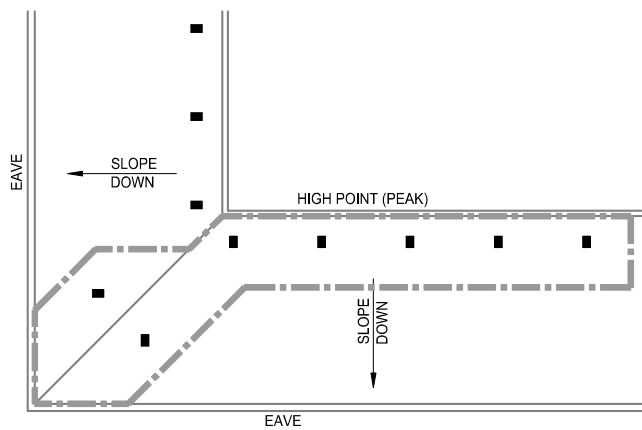

FIGURE 26A
1 ROW PROTECTION CALCULATION

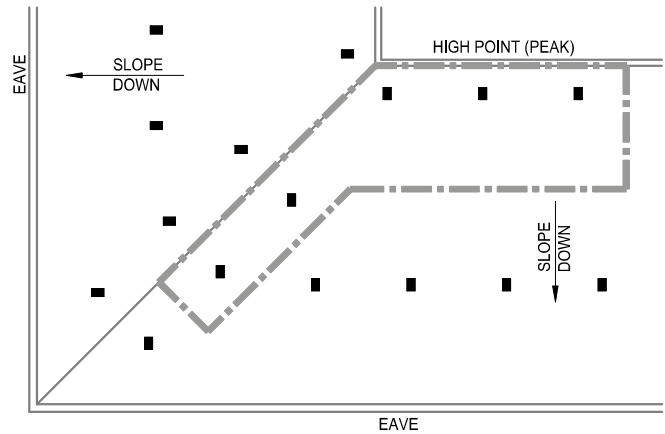

FIGURE 26B
2 ROW PROTECTION CALCULATION #1

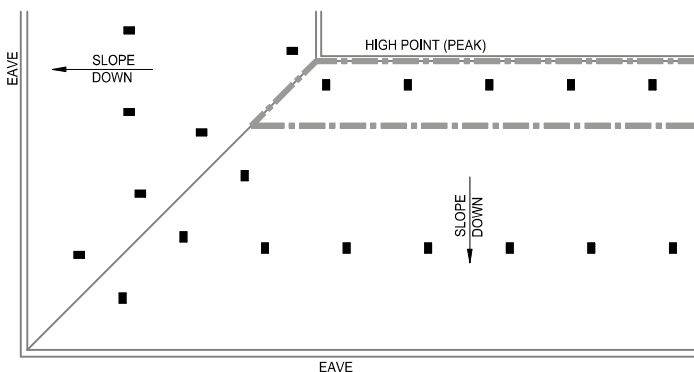
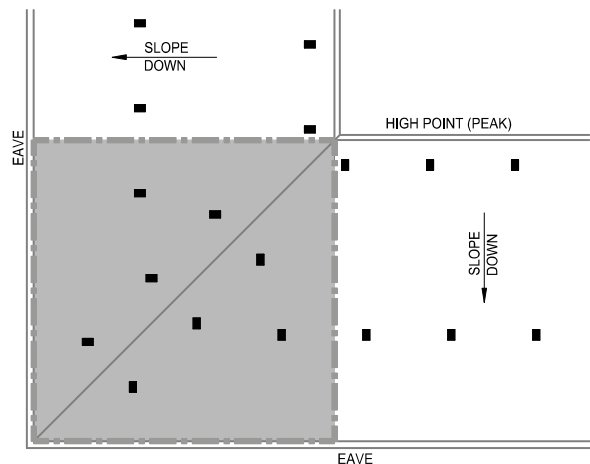

FIGURE 26C
2 ROW PROTECTION CALCULATION #2



FFIGURE 26D
2 ROW PROTECTION CALCULATION #3

FIGURE 26: SINGLE SLOPE WITH HIP - WET SYSTEM DESIGN

5.0 PERFORMANCE (CONTINUED)

Hydraulic Criteria For Single Slope With Hip Dry System Only

1 Row Protection

- Calculate the 7 most hydraulically demanding contiguous DS sprinklers located along the high point plus the 2 most demanding sprinklers along the hip line. See Figure 27A.
- Minimum sprinkler flow is 20 gpm per sprinkler.

2 Row Protection

The following 3 sets of calculations shall be performed:

- Calculation #1: Calculate the 7 most hydraulically demanding contiguous DS sprinklers located along the high point (peak) plus the 2 most demanding sprinklers along the hip line. See Figure 27B.
- Calculation #2: Calculate all sprinklers within the shaded corner Hip area as shown. See Figure 27C.
- Minimum sprinkler flow is 20 gpm per sprinkler.

NOTE

- The "plus 2" most demanding sprinklers along the hip line may vary from that shown in the figures depending on actual piping. Designer may need to investigate multiple options to determine the 2 most demanding sprinklers to incorporate into the calculations.

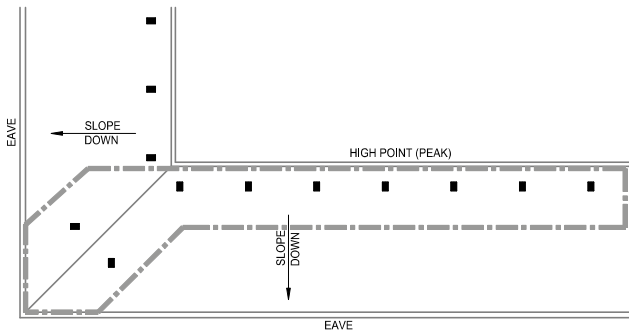

FIGURE 27A
1 ROW PROTECTION CALCULATION

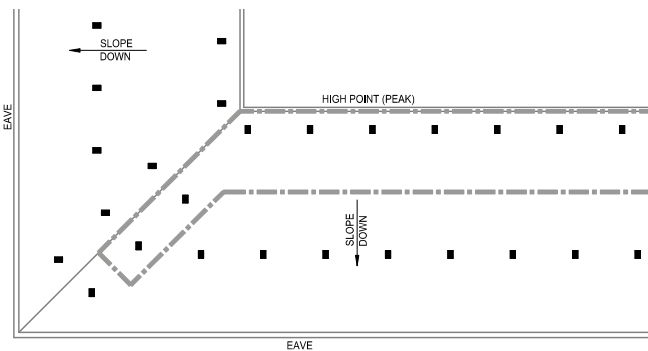
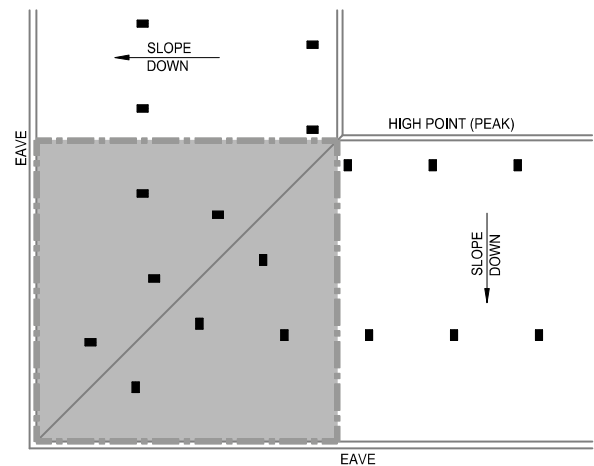

FIGURE 27B
2 ROW PROTECTION CALCULATION #1



FFIGURE 27C
2 ROW PROTECTION CALCULATION #2

FIGURE 27: SINGLE SLOPE WITH HIP – DRY SYSTEM DESIGN

5.0 PERFORMANCE (CONTINUED)

Obstructions

The following guidelines outline criteria to minimize critical obstructions to spray pattern development and to maximize effectiveness in achieving control. Although also "obstruction criteria" some criteria has nothing to do with distribution but allowing heat to travel uninhibited to activate sprinklers. For simplicity much of the obstruction criteria has been standardized for all sprinkler types but be sure to adhere to the sprinkler specific criteria towards the bottom of the list.

General

- Structural trusses and web members are not considered "obstructions" provided a minimum 6" lateral distance from sprinklers to side of truss/web member is maintained. See Figure 28.
- FL-SA/BB, FL-SA/GAP and FL-SA/DS sprinklers may be installed directly on maximum nominal 2½" (DN65) pipe without the need for a "Sprig-up". For pipe larger than 2½" nominal, see NPFA 13 for Sprig requirements.
- Sprinklers shall be positioned away from obstructions a minimum distance of Four (4) times the maximum dimension of the obstruction (e.g. Ducts, pipe). This 4X requirement does not apply to truss web members provided the web members do not exceed 6" and the minimum lateral distance of 6" from sprinkler to side of member is maintained in accordance with Figure 30.

Obstruction criteria is grouped into the following categories

Vertical Obstructions

Those obstructions which run vertically through the attic. These may consist of fireplace flues, walls, vents, stacks, etc. These obstructions will typically run up to or penetrate the roof deck. See Figure 29 for criteria.

Suspended Horizontal Obstructions

Those obstructions which are typically "suspended" within the attic space itself and run horizontally. These obstructions will have clearance over and under the obstruction to allow discharge of water around the obstruction. These obstructions may consist of ductwork; walkways; etc. Horizontal obstructions located within 1'-0" vertically of the bottom chords or ceiling joists below are not considered "Suspended" Horizontal Obstructions. See Figure 30 for details.

Obstructions at Upper Deck

Those obstructions which are either attached directly to the roof deck or to the top chords/joists of the roof framing in a manner that little to no discharge of water can pass/clear the top of the obstruction. These obstructions can have an impact on the upper portion of the spray pattern from sprinklers. See Figure 30 for details.

FL-SA/BB and FL-SA/DS Specific Obstruction

Criteria

Those obstructions which are either attached directly to the roof deck or to the top chords/joists of the roof framing in a manner that little to no discharge of water can pass/clear the top of the obstruction. These obstructions can have an impact on the upper portion of the spray pattern from sprinklers. See Figure 30 for details.

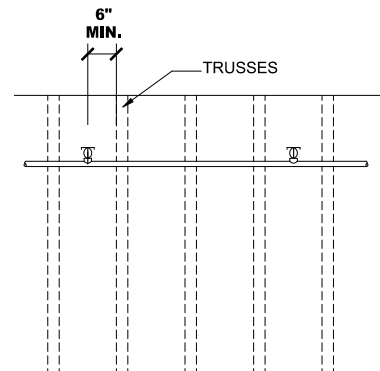
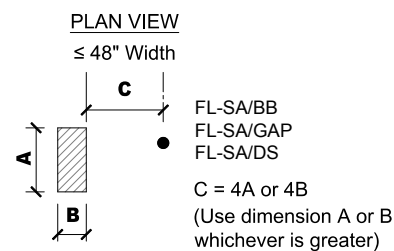

FIGURE 28: MINIMUM REQUIRED LATERAL DIMENSION FROM FACE OF CHORDS AND WEB MEMBERS FOR FL-SA/BB, GAP AND DS SPRINKLERS



Should the sprinkler not be able to be located a distance of 4X away from obstruction, an additional sprinkler must be installed on the opposite side of the obstruction within 1'-0" from the opposite side of the obstruction.

FIGURE 27B
 2 ROW PROTECTION CALCULATION #1

FIGURE 29: VERTICAL OBSTRUCTION CRITERIA FOR FL-SA/BB, GAP AND DS SPRINKLERS

5.0 PERFORMANCE (CONTINUED)

Obstructions

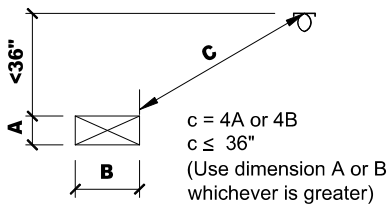

No additional sprinkler required below, if equal to or less than 48" suspended obstruction.

FIGURE 30A

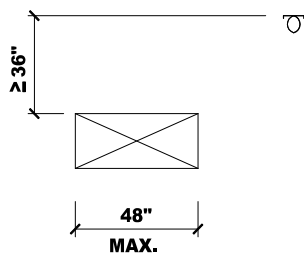
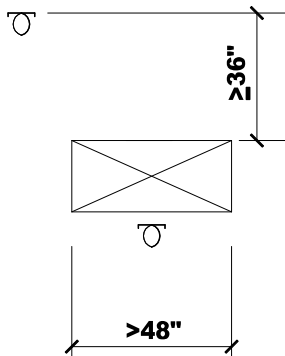

FIGURE 30B



Additional sprinkler required below, if greater than 48" suspended obstruction.

FIGURE 30C

FIGURE 30: SUSPENDED HORIZONTAL OBSTRUCTIONS GL-SS/ BB, RE AND DS SPRINKLERS

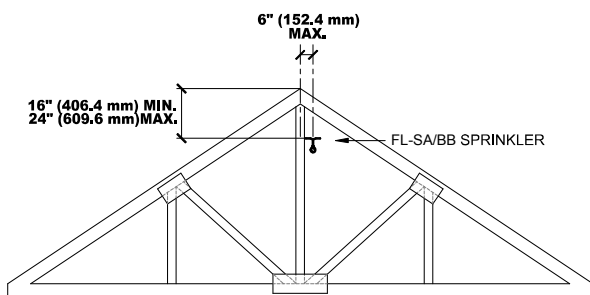

FIGURE 31A

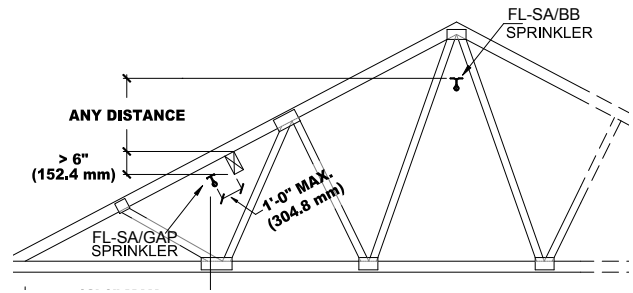

FIGURE 31B

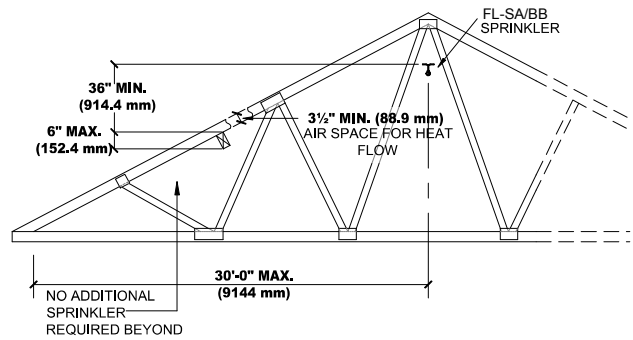

FIGURE 31C

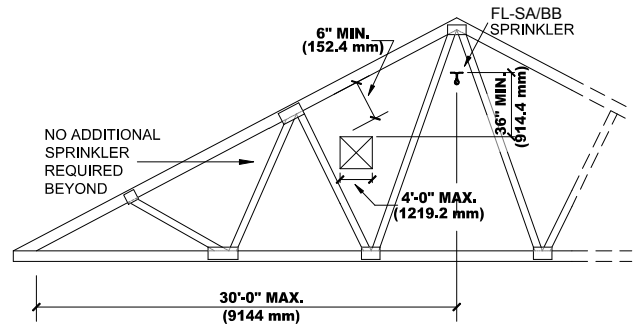

FIGURE 31D

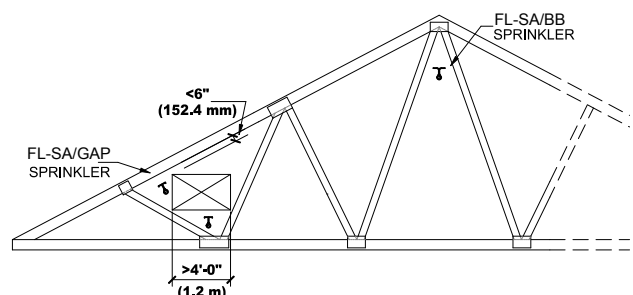
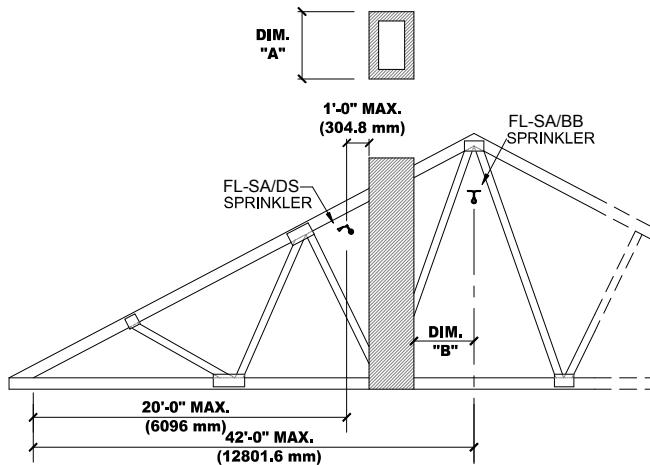

FIGURE 31E

FIGURE 31: FL-SA/BB AND FL-SA/DS SPRINKLER OBSTRUCTIONS (CONT. NEXT PAGE)

5.0 PERFORMANCE (CONTINUED)

Obstructions



Dimension A	Dimension B	
Maximum Horizontal Dimension of Obstruction inches (mm)	Minimum Horizontal Distance to Obstruction inches (mm)	Additional Sprinkler Required Beyond Obstruction
All Vertical Obstructions	<6" (152.4)	Yes
½" < 1" (12.7 – 25.4)	6" (152.4)	No
1" < 4" (25.4 < 101.6)	12" (304.8)	No
4" < 8" (101.6 < 203.2)	24" (609.6)	No
8" < 10" (203.2 < 254)	5'-0" (1.52)	No
10" < 20" (254 < 508)	10'-0" (3.05)	No
20" < 30" (508 < 762)	15'-0" (4.57)	No
30" < 40" (762 < 1016)	20'-0" (6.10)	No
40" < 48" (1016 < 1219.2)	25'-0" (7.62)	No
>48" (1219.2)	Any Distance	Yes

Piggyback Trusses

When trusses are stacked (“Piggyback”) at the peak, consideration to obstructions to the spray pattern of the FL-SA/BB sprinklers must be made. These “Piggyback” configurations will typically include 2x “Stiffeners” running perpendicular to the trusses. Additionally, these “stiffeners” will be sandwiched between the uppermost and lowermost horizontal chords of the two stacked trusses.

In the event that all members are above the level of the FL-SA/BB deflector, no obstruction exists to the FL-SA/BB spray pattern. See Figure 32.

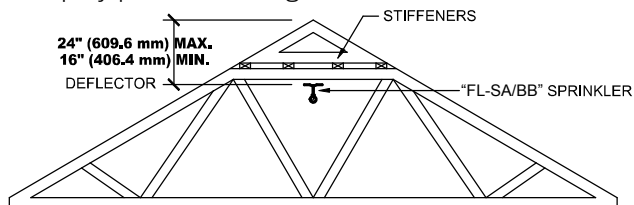

FIGURE 32: DEFLECTOR COMPLETELY BELOW STIFFENERS AND HORIZONTAL WEB MEMBERS (NO OBSTRUCTION)

In the event that the FL-SA/BB Deflector is located completely above the stiffeners and horizontal web members, the parameters of Figure 33 as appropriate, must be met for the spray pattern to be considered unobstructed.

When all of the following are met, additional sprinkler(s) below stiffeners are not required:

- The FL-SA/BB sprinklers are located a minimum of 12 in. (304.8 mm) above the stiffeners.
- The stiffeners are 7½ in. (190.5 mm) maximum in width
- The openings are 12 in. (304.8 mm) minimum
- There is 70% minimum open area

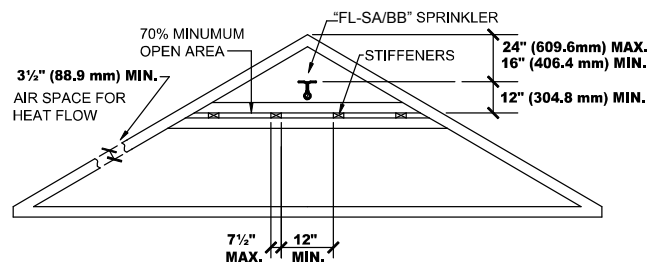

FIGURE 33: DEFLECTOR ABOVE STIFFENERS AND HORIZONTAL WEB MEMBERS (NO OBSTRUCTION)

When the FL-SA/BB sprinklers are located above the stiffeners, but do not meet all of the parameters of Figure 34 the FL-SA/BB sprinklers must be located in accordance with Figure ZZ relative to the stiffeners.



DIMENSION A	DIMENSION B		
	BB46	BB79	BB1012
A > 0"	A=15"	A+10"	A=8"

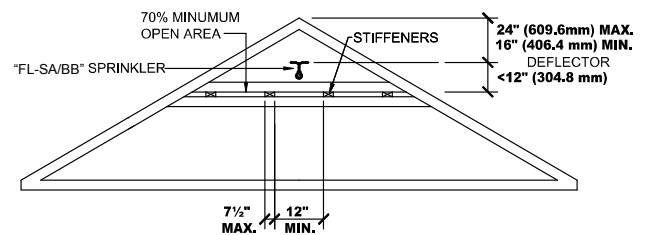

FIGURE 34: DEFLECTOR LESS THAN 12" ABOVE STIFFENERS (NO OBSTRUCTION)

5.0 PERFORMANCE (CONTINUED)

Installation

The Specific Application Attic Sprinklers for Protecting Attics must be installed in accordance with this section.

The FL-SA/BB, FL-SA/GAP and FL-SA/DS Specific Application Attic Sprinklers comprise an overall protection scheme which takes into account strategic positioning for activation sensitivity while providing unique distribution characteristics specifically designed for attic construction.

These Special Application Sprinklers and this Protection Scheme cannot be utilized with any "other" spray sprinklers with the exception of small standalone dormers and similar isolated compartments/areas requiring 4 or less sprinklers.

The protection methodology utilizing these sprinklers has been full scale fire tested in the built attic environment. As such, they must be installed in accordance with the guidelines set forth within this data sheet. The NFPA 13 Density/ Area prescriptive spacing requirements do not apply as these sprinklers are not bound by the NFPA 13 "S x L Rules". The positioning and spacing requirements of this data sheet take precedence over any other prescriptive requirements that may exist in NFPA 13.

To install the Specific Application Attic Sprinklers, the following steps shall be taken:

Step 1. Sprinklers must be oriented correctly as follows:

- Series FL-SA/BB Sprinklers
 - At horizontal ridge (peak) – installed in the upright vertical position with deflector parallel to the ceiling below (i.e. sprinkler centerline perpendicular to the ridgeline).
 - The FL-SA/BB sprinklers must only be installed at ridge lines where the truss framing members run parallel to the long direction of throw of the FL-SA/BB sprinkler (i.e. sprinkler frame arms are perpendicular to the roof trusses). See Figure 28.

- Series FL-SA/GAP Sprinklers
 - Near eave or under-hip type roofs – installed in the upright position with deflector parallel to roof deck (i.e. sprinkler centerline perpendicular to the roof slope).
- Series FL-SA/DS Sprinklers
 - Installed in the upright position with deflector parallel to roof deck (i.e. sprinkler centerline perpendicular to the roof slope).
 - For this design methodology, the FL-SA/DS sprinklers may typically be utilized at the Hip roof area adjacent to the hip line of the roof and positioned to throw out towards the eaves. Truss framing members must run parallel to the long direction of throw of the FL-SA/DS sprinkler. See FIGURE 35 for reference.

Step 2. With pipe thread sealant applied to the pipe threads, hand tighten the sprinkler into the sprinkler fitting.

NOTE

- Do not grasp the sprinkler by the deflector.

Step 3. Wrench-tighten the sprinkler using only the appropriate wrench. Wrenches are only to be applied to the sprinkler wrench flats or wrench hex, as applicable.

NOTE

- Do not apply wrench to frame arms.

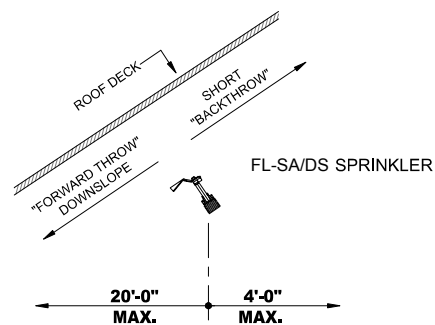

FIGURE 35: SPRINKLER FRAME ORIENTATION TO ROOF SLOPE

5.0 PERFORMANCE (CONTINUED)

CPVC Guidelines

Use of UL Listed CPVC Piping with Specific Application Attic Sprinklers Wet Systems Only

UL Listed CPVC piping may be used in a combustible concealed attic space requiring sprinklers when installed in accordance with the following guidelines. For clarity, the following guidelines reference both "Gable/Downslope" areas as well as "Hip" areas. Refer to Figure 1 on page 1 for explanation of these areas.

Notice

Where the use of non-combustible insulation is specified, verify with the insulation manufacturer as to the non-combustibility of the insulation. The non-combustible insulation (fiberglass) may be faced or unfaced. Where faced, the facing need not be non-combustible. The insulation is to have a flame spread index of not more than 25. Verify chemical compatibility of the insulation with the UL Listed CPVC by consulting the CPVC Manufacturer's literature.

CPVC At Bottom Chords To Feed Ceiling Sprinklers Below

UL Listed CPVC may be used to feed the wet system ceiling sprinklers on the floor below when adhering to the following guidelines: (See Figure 36)

- Wet Systems only
- The area above must be protected by FL-SA/BB, FL-SA/GAP and/or FL-SA/DS Sprinklers.
- Pipe Running on Top of Bottom Chords: There must be 6 in. (152.4 mm) of non-combustible insulation covering the horizontal or vertical pipe extending 12 in. (304.8 mm) on each side away from the centerline of the pipe. Refer to Figure 36A.
- Pipe Running Within Joist Channel: If the pipe is located inside the ceiling joist, the joist channel must be covered or filled with 6 in. (152.4 mm) of non-combustible insulation on top of the pipe. Refer to Figure 36B. Insulation is for fire protection purposes. It is not freeze protection. CPVC must be installed in accordance with the CPVC Manufacturer's installation guide instructions.

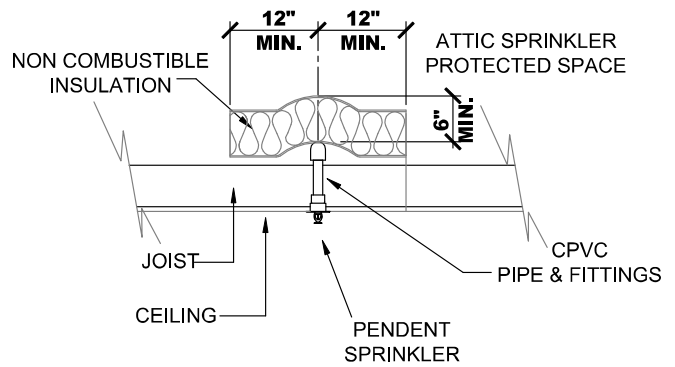

FIGURE 36A

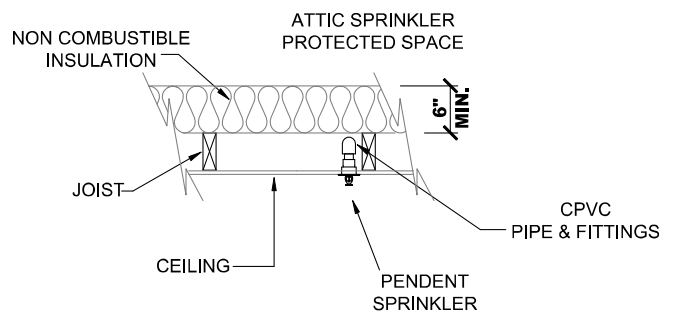

FIGURE 36B

FIGURE 36: NON-COMBUSTIBLE INSULATION FOR THE PROTECTION OF CPVC PIPE

5.0 PERFORMANCE (CONTINUED)

CPVC Guidelines

Use of UL Listed CPVC Piping with Specific Application Attic Sprinklers Wet Systems Only (Continued)

CPVC at Gable/Downslope Areas Only

UL Listed CPVC Pipe and Fittings may be used to feed the Specific Application Attic Sprinklers protecting the attic space when adhering to the following guidelines: (See Figure 37)

- Wet Systems only
- Risers are vertical and protected by Specific Application Sprinklers located at a maximum lateral distance of 12 in. (304.8 mm) from the riser centerline.
- Specific Application Sprinklers are directly mounted on the branchline.
- Specific Application Sprinklers are on arm-overs and located at a maximum lateral distance of 6 in. (152.4 mm) from the branchline centerline.
- Specific Application Sprinklers are on vertical sprigs attached to the branchline.

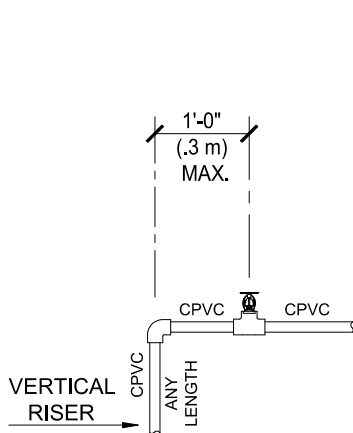

FIGURE 37A: VERTICAL RISER DIRECT MOUNT

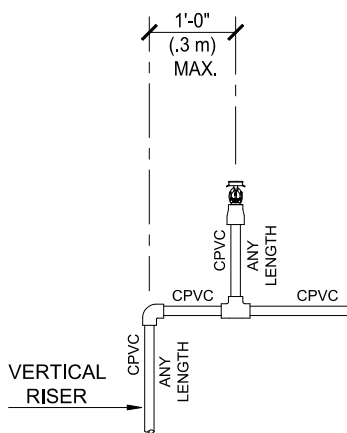

FIGURE 37B: VERTICAL RISER SPRIG UP

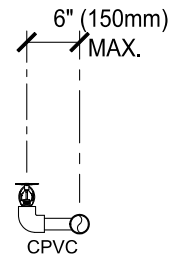

FIGURE 37C: DIRECT MOUNT ARM-OVER

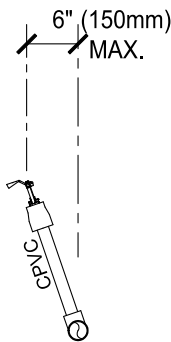

FIGURE 37D: ANGLED SPRIG

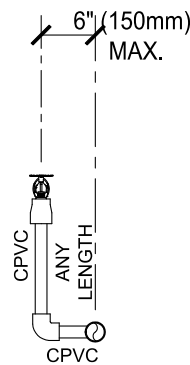

FIGURE 37E: ARM OVER SPRIG

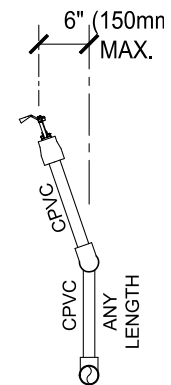

FIGURE 37F: VERTICAL SPRIG WITH SWING JOINT

FIGURE 37: CPVC ALLOWANCE GUIDELINES WET SYSTEMS ONLY (GABLE/DOWNSLOPE AREA)

5.0 PERFORMANCE (CONTINUED)

CPVC Guidelines

CPVC at Hip Areas

Listed CPVC may be used to feed the FL-SA/GAP and FL-SA/DS sprinklers protecting the Hip areas when adhering to the following guidelines:

- Wet systems only
- When the horizontal branchline piping feeding sprinklers within the hip roof areas is run over the bottom chords of the trusses, it shall be covered with a minimum of 6 in. (152.4 mm) in depth of non-combustible insulation (See Figure 38). This insulation must extend nominally 12 in. (304.8 mm) on each side away from the centerline of the CPVC branchline. Insulation is for fire protection purposes. It is not freeze protection.
- When the horizontal CPVC branchline piping feeding the sprinklers within the hip roof areas is located within the ceiling joist, the joist channel must be covered or filled with a minimum of 6 in (152.4 mm) depth of noncombustible insulation on top of the branchline feeding the sprigs (See Figure 39). Insulation is for fire protection purposes. It is not freeze protection.
- A minimum lateral distance of 18 in (450 mm) is maintained between the CPVC pipe and a heat producing device such as heat pumps, fan motors, and heat lamps.
- The sprinklers (GAP or DS) may be directly fed by exposed vertical or angled sprigs provided:
 - Vertical sprigs have no maximum exposed length, the GAP or DS Sprinkler is located at a maximum lateral distance of 12 in (3304.8 mm) from the sprig centerline.
 - Angled sprigs with a maximum exposed length of 3 ft. (0.9 m).

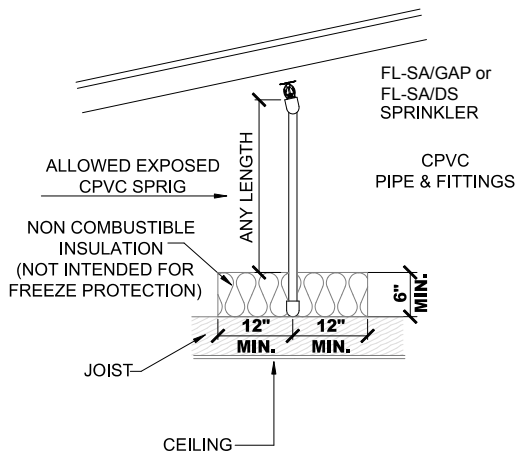

FIGURE 38A: VERTICAL SPRIG

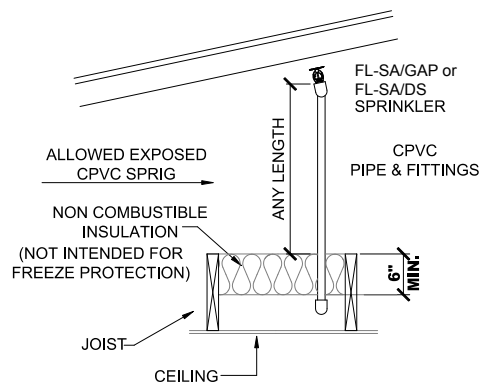

FIGURE 39A: VERTICAL SPRIG

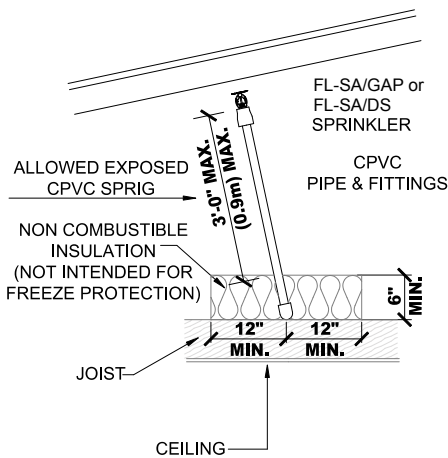

FIGURE 38B: ANGLED SPRIG

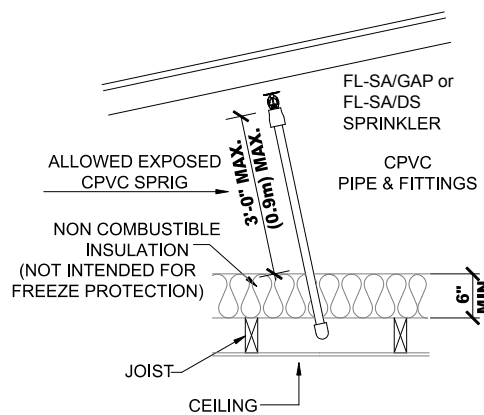



FIGURE 39B: ANGLED SPRIG

FIGURE 38: EXPOSED CPVC AT HIP ROOF AREAS (HORIZONTAL BRANCHLINE OVER JOISTS) WET SYSTEMS ONLY

FIGURE 39: EXPOSED CPVC AT HIP ROOF AREAS (HORIZONTAL BRANCHLINE WITHIN JOISTS) WET SYSTEMS ONLY

6.0 NOTIFICATIONS

⚠ WARNING



- Read and understand all instructions before attempting to install any Victaulic products.
- Always verify that the piping system has been completely depressurized and drained immediately prior to installation, removal, adjustment, or maintenance of any Victaulic products.
- Wear safety glasses, hardhat, and foot protection.

Failure to follow these instructions could result in death or serious personal injury and property damage.

- These products shall be used only in fire protection systems that are designed and installed in accordance with current, applicable National Fire Protection Association (NFPA 13, 13D, 13R, etc.) standards, or equivalent standards, and in accordance with applicable building and fire codes. These standards and codes contain important information regarding protection of systems from freezing temperatures, corrosion, mechanical damage, etc.
- The installer shall understand the use of this product and why it was specified for the particular application.
- The installer shall understand common industry safety standards and potential consequences of improper product installation.
- It is the system designer's responsibility to verify suitability of materials for use with the intended fluid media within the piping system and external environment.
- The material specifier shall evaluate the effect of chemical composition, pH level, operating temperature, chloride level, oxygen level, and flow rate on materials to confirm system life will be acceptable for the intended service.

Failure to follow installation requirements and local and national codes and standards could compromise system integrity or cause system failure, resulting in death or serious personal injury and property damage.

7.0 REFERENCE MATERIALS

Ratings: All glass bulbs are rated for temperatures from -67°F/-55°C.

[I-40: Victaulic FireLock™ Automatic Sprinklers Installation and Maintenance Instructions](#)

User Responsibility for Product Selection and Suitability

Each user bears final responsibility for making a determination as to the suitability of Victaulic products for a particular end-use application, in accordance with industry standards and project specifications, and the applicable building codes and related regulations as well as Victaulic performance, maintenance, safety, and warning instructions. Nothing in this or any other document, nor any verbal recommendation, advice, or opinion from any Victaulic employee, shall be deemed to alter, vary, supersede, or waive any provision of Victaulic Company's standard conditions of sale, installation guide, or this disclaimer.

Intellectual Property Rights

No statement contained herein concerning a possible or suggested use of any material, product, service, or design is intended, or should be construed, to grant any license under any patent or other intellectual property right of Victaulic or any of its subsidiaries or affiliates covering such use or design, or as a recommendation for the use of such material, product, service, or design in the infringement of any patent or other intellectual property right. The terms "Patented" or "Patent Pending" refer to design or utility patents or patent applications for articles and/or methods of use in the United States and/or other countries.

Note

This product shall be manufactured by Victaulic or to Victaulic specifications. All products to be installed in accordance with current Victaulic installation/assembly instructions. Victaulic reserves the right to change product specifications, designs and standard equipment without notice and without incurring obligations.

Installation

Reference should always be made to the Victaulic installation handbook or installation instructions of the product you are installing. Handbooks are included with each shipment of Victaulic products, providing complete installation and assembly data, and are available in PDF format on our website at www.victaulic.com.

Warranty

Refer to the Warranty section of the current Price List or contact Victaulic for details.

Trademarks

Victaulic and all other Victaulic marks are the trademarks or registered trademarks of Victaulic Company, and/or its affiliated entities, in the U.S. and/or other countries.