

Stroke-to-GO™ Switch

Models 7C, 7D, 7E, 7F contact. When the actuator is removed, the magnet again becomes dominant on the N/C side and the armature returns to its N/C position.

Cylinder Position Sensor

Stroke-To-GO™ Switches provide precise end-of-stroke position indication on pneumatic and hydraulic cylinders. Designed to exceed automotive industry standards, the housing is machined from stainless steel bar stock to handle pressures to 3,000 PSI operating (tested to UL's 4X burst requirement) while withstanding the extreme external conditions such as weld slag, coolants, cutting fluids, physical abuse and even high temperatures. Stroke-to-GO™ Switches incorporate the same 70 Series GO™ Switch mechanism that has been tested to over 200 million mechanical cycles and field proven in the most rigorous applications. This unique design offers the greatest benefits in cylinder position indication.

Unique Features

Mechanical life:
>200,000,000 cycles

Leakage current:
Without LEDs - none
With LEDs - <1.7mA

Voltage Drop:
Without LEDs - none
With LEDs - <5V (SPST)

Temperature drift: none

Wash-down: designed to withstand 1,000 PSI wash-down and NEMA 6P with Mini-Change® type connector option

Underwater: rated to 10,000 PSI with deep sea connector option

Weld Field Immune: tested and exceeded General Motors EHS-320 specifications. Testing Agency - Candid Logic

Radio Frequency Interference (RFI): no affect at any frequency

Application Considerations

- Cylinder cushion must be ferrous.
- Air gap between switch sensing face and cushion should be .015" to .040" (outside this range please consult factory).
- Largest diameter of target (cushion) should cover at least 75% of probe sensing face.
- Sensing face of Stroke-To-GO™ Switch must be at least .125" from piston rod for proper switch reset. This may at times require an air gap distance greater than .040".
- For cushion diameters less than .50", air gap should be .015" to .025".

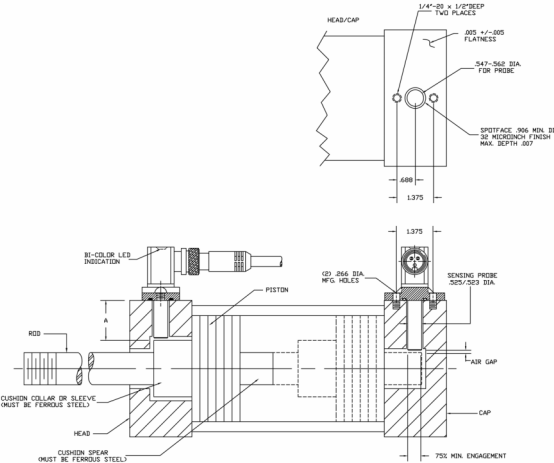

Figure 1

Specifications

Housing
Size: Standard probe lengths: 1.025" (26 mm), 1.250" (32 mm) and 2.062" (52mm). Custom probe lengths:** 1.000" (26 mm) - 5.000" (127 mm)

Materials: Stainless Steel bar stock

Conduit Outlet: Mini-change standard

Sensing
Target Material: Ferrous Sensing
Range: Approx. .090" (2 mm) end sensing (3,000 PSI) (Recommended air gap .015" - .040")

Contacts

Materials: Palladium silver
Form: Single Pole, Double Throw, Form C (w/ or w/o LED indication) Single Pole, Single Throw (w/ or w/o LED indication) Form A or Form B

Most Popular Models



7C-23658-DCA

SPST with LEDs, approx. .090" (2.3 mm) end sensing, stainless steel 1.025" (26 mm) probe, 360° adjustable side outlet with 3 pin mini change connector. < 1mA leakage current.



7E-43658-DCA

SPDT, (no LED) approx. .090" (2.3 mm) end sensing, stainless steel 2.062" (52 mm) probe, 360° adjustable side outlet with 3 pin mini change connector. No leakage current.

Probe Lengths Greater than 1.025"

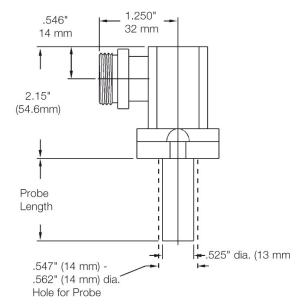

Probe Lengths 1.025" and less

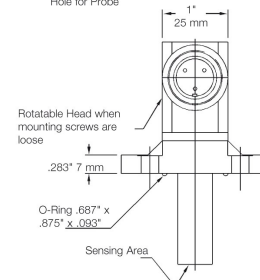
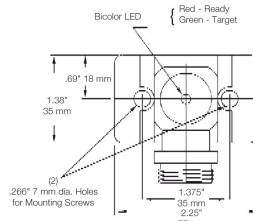
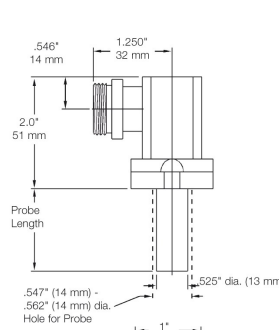

Performance

Repeatability: .002" (.05 mm) typical
Response Time: 8 milliseconds
Differential: Approximately .020" (.51 mm)
Operating Temperature: -40°F (-40°C) to 160°F (71°C) With LEDs -40°F (-40°C) to 221°F (105°C) Without LEDs; 400°F (204°C) optional

Pressure Rating: Stainless steel 3,000 PSI operating (UL tested 4x burst)

Approvals: UL



**Probe lengths shorter than 1.00" are available with taller upper switch housing.

Wiring Diagrams

Contact Forms		Leads			Cable	Water-Resistant	Hi Temp
		UL	UL	UL	UL		
2-SPDT Form A N/O w/LED	COM	Black	Black	Black	Black		N/A
	N/O	Blue	White	White	White		
	GND	Green	Red	Red	Red		
3-SPDT Form B N/C w/ LED	COM	Black	Black	Black	Black		N/A
	N/C	Red	Red	Red	Red		
	GND	Green	White	White	White		
4-SPDT Form C No Led	COM	Black	Black	Black	Black		Black
	N/O	Blue	White	White	White		Blue
	N/C	Red	Red	Red	Red		Red
	GND						
5-SPDT Form C Dual LEDs	COM	Black	Black	Black	Black		N/A
	N/O	Blue	White	White	White		
	N/C	Red	Red	Red	Red		
7-SPDT Form A N/O w/o LED	COM	Black	Black	Black	Black		Black
	N/O	Blue	White	White	White		Blue
	GND	Green	Red	Red	Red		Green
8-SPDT Form B N/C w/o LED	COM	Black	Black	Black	Black		Black
	N/C	Red	Red	Red	Red		Red
	GND	Green	White	White	White		Green

3 Pin Micro-Change With or without LEDs

SPST, Form A, N/O	
PIN 1	GND
PIN 2	COM
PIN 3	N/O

SPST, Form B, N/C	
PIN 1	GND
PIN 2	COM
PIN 3	N/C

SPDT, Form C	
PIN 1	COM
PIN 2	N/C
PIN 3	N/O

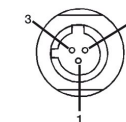

4 Pin Micro-Change With or without LEDs

SPST, Form A, N/O	
PIN 1	COM
PIN 2	N/O
PIN 3	INACTIVE
PIN 4	GND

SPST, Form B, N/C	
PIN 1	COM
PIN 2	INACTIVE
PIN 3	N/C
PIN 4	GND

SPDT, Form C	
PIN 1	COM
PIN 2	N/O
PIN 3	N/C
PIN 4	GND

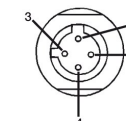

EC Declaration of Conformity

The products described herein, conform to the provisions of the following European Community Directives, including the latest amendments:

Low Voltage Directive (2006/95/EC)
EMC Directive (2004/108/EC)
Machinery Directive (2006/42/EC)
ATEX Directive (94/9/EC).

Wiring Diagrams

3 Pin Mini-Change with or without LED

SPST, Form A, N/O

PIN 1	GND
PIN 2	COM
PIN 3	N/O

SPST, Form B, N/C

PIN 1	GND
PIN 2	COM
PIN 3	N/C

SPDT, Form C

PIN 1	COM
PIN 2	N/C
PIN 3	N/O

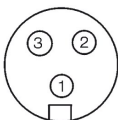

3 Pin SubSea without LED

SPST, Form A, N/O

PIN 1	COM
PIN 2	N/O
PIN 3	GND

SPST, Form B, N/C

PIN 1	COM
PIN 2	N/C
PIN 3	GND

SPDT, Form C

PIN 1	N/C
PIN 2	COM
PIN 3	N/O

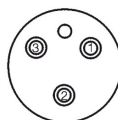

4 Pin Mini-Change with or without LED

SPST, Form A, N/O

PIN 1	COM
PIN 2	N/O
PIN 3	INACTIVE
PIN 4	GND

SPST, Form B, N/C

PIN 1	COM
PIN 2	INACTIVE
PIN 3	N/C
PIN 4	GND

SPDT, Form C

PIN 1	COM
PIN 2	N/O
PIN 3	N/C
PIN 4	GND

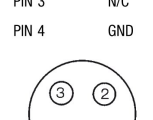

4 Pin SubSea without LED

SPST, Form A, N/O

PIN 1	COM
PIN 2	N/O
PIN 3	INACTIVE
PIN 4	GND

SPST, Form B, N/C

PIN 1	COM
PIN 2	INACTIVE
PIN 3	N/C
PIN 4	GND

SPDT, Form C

PIN 1	COM
PIN 2	N/O
PIN 3	N/C
PIN 4	GND

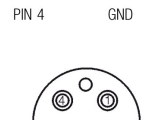

5 Pin Mini-Change with or without LED

SPST, Form A, N/O

PIN 1	N/O
PIN 2	Inactive
PIN 3	GND
PIN 4	Inactive
PIN 5	COM

SPST, Form B, N/C

PIN 1	Inactive
PIN 2	N/C
PIN 3	GND
PIN 4	Inactive
PIN 5	COM

SPDT, Form C

PIN 1	N/O
PIN 2	N/C
PIN 3	GND
PIN 4	Inactive
PIN 5	COM

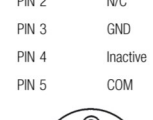

3 Pin SubSea - Right Angle without LED

SPST, Form A, N/O

PIN 1	COM
PIN 2	N/O
PIN 3	GND

SPST, Form B, N/C

PIN 1	COM
PIN 2	N/C
PIN 3	GND

SPDT, Form C

PIN 1	COM
PIN 2	N/O
PIN 3	N/C

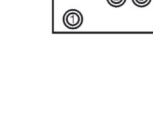

TERMS AND CONDITIONS OF SALE

These terms and conditions, the attendant quotation or acknowledgment, and all documents incorporated by reference therein, binds TopWorx, Inc. hereinafter the Seller, and the buyer, hereinafter Buyer, and constitutes the entire agreement (Agreement) between Buyer and Seller for the provision of services (Services) and/or the sale of goods (Goods) including (except as provided in Section 10) firmware incorporated therein.

1. PRICES: Unless otherwise specified by Seller, Seller's price for the Goods and/or Services shall remain in effect for thirty (30) days after the date of Seller's quotation or acceptance of the order for the Goods/Services, whichever is delivered first, provided an unconditional, complete authorization for the immediate manufacture and shipment of the Goods and/or provision of Services pursuant to Seller's standard order processing procedures is received and accepted by Seller within such time period. If such authorization is not received by Seller within such thirty (30) day period, Seller shall have the right to change the price for the Goods/Services to Seller's price in effect for the Goods/Services at the time the order is released to final manufacture. Prices for Goods do not cover storing, installing, starting up or maintaining Goods unless expressly stated in Seller's quotation. Notwithstanding the foregoing, the price for Goods/Services sold by Seller, but manufactured by others, shall be Seller's price in effect at the time of shipment to Buyer.

2. DELIVERY, ORDER ACCEPTANCE AND DOCUMENTATION: All shipping dates are approximate and are based upon Seller's prompt receipt of all necessary information from Buyer to properly process the order. Notwithstanding any provisions to the contrary in this or other documents related to this transaction, and regardless of how price was quoted, whether FOB, FAS, CIF or otherwise, legal title to the Goods and risk of loss thereto shall transfer to Buyer as follows: for sales in which the end destination of the Goods is within the United States, upon delivery to the freight carrier at the shipping point, for sales in which the end destination of the Goods is outside of the United States, immediately after the Goods have passed beyond the territorial limits of the United States. Seller shall provide Buyer with that data/documentation which is specifically identified in the quotation. If additional copies of data/documentation or non-standard data/documentation are to be provided by Seller, they shall be provided to Buyer at Seller's price then in effect. Data/documentation marked as confidential or proprietary may not be reproduced or used for any purpose other than the purpose for which it was provided and may not be disclosed to third parties without the prior written permission of Seller.

3. EXCUSE OF PERFORMANCE: Seller shall not be liable for delays in performance or for non-performance due to failure or interruption of computer or telecommunication systems, acts of God, war, riot, fire, terrorism, labor trouble, unavailability of materials or components, explosion, accident, compliance with governmental requests, laws, regulations, orders or actions, or other unforeseen circumstances or causes beyond Seller's reasonable control. In the event of such delay, the time for performance or delivery shall be extended by a period of time reasonably necessary to overcome the effect of the delay.

4. TERMINATION AND SUSPENSION BY BUYER: Buyer may terminate or suspend its order for any or all of the Goods/Services covered by the Agreement provided that Buyer gives Seller reasonable advance written notice of such termination or suspension and reimburses Seller for all losses, damages, costs and expenses arising from such termination or suspension.

5. LIMITED WARRANTY: Subject to the limitations contained in Section 6 herein, Seller warrants that the licensed firmware embodied in the Goods will execute the programming instructions provided by Seller, and that the Goods manufactured or Services provided by Seller will be free from defects in materials or workmanship under normal use and care. The foregoing warranties will apply until the expiration of the applicable warranty period. All other Goods are warranted for twelve (12) months from the date of shipment by Seller. Consumables and Services are warranted for a period of 90 days from the date of shipment or completion of the Services. Products purchased by Seller from a third party for resale to Buyer ("Resale Products") shall carry only the warranty extended by the original manufacturer. Buyer agrees that Seller has no liability for Resale Products beyond making a reasonable commercial effort to arrange for procurement and shipping of the Resale Products. If Buyer discovers any warranty defects and notifies Seller thereof in writing during the applicable warranty period, Seller shall, at its option, correct any errors that are found by Seller in the firmware or Services or repair or replace F.O.B. point of manufacture that portion of the Goods or firmware found by Seller to be defective, or refund the purchase price of the defective portion of the Goods/Services. All replacements or repairs necessitated by inadequate maintenance, normal wear and usage, unsuitable power sources or environmental conditions, accident, misuse, improper installation, modification, repair, use of unauthorized replacement parts, storage or handling, or any other cause not the fault of Seller are not covered by this limited warranty, and shall be at Buyer's expense. Seller shall not be obligated to pay any costs or charges incurred by Buyer or any other party except as may be agreed upon in writing in advance by Seller. All costs of dismantling, reinstallation and freight and the time and expenses of Seller's personnel and representatives for site travel and diagnosis under this warranty clause shall be borne by Buyer unless accepted in writing by Seller. Goods repaired and parts replaced by Seller during the warranty period shall be in warranty for the remainder of the original warranty period or ninety (90) days, whichever is longer. This limited warranty is the only warranty made by Seller and can be amended only in a writing signed by Seller. THE WARRANTIES AND REMEDIES SET FORTH ABOVE ARE EXCLUSIVE. THERE ARE NO REPRESENTATIONS OR WARRANTIES OF ANY KIND, EXPRESS OR IMPLIED, AS TO MERCHANTABILITY, FITNESS FOR PARTICULAR PURPOSE OR ANY OTHER MATTER WITH RESPECT TO ANY OF THE GOODS OR SERVICES.

6. LIMITATION OF REMEDY AND LIABILITY: SELLER SHALL NOT BE LIABLE FOR DAMAGES CAUSED BY DELAY IN PERFORMANCE. THE REMEDIES OF BUYER SET FORTH IN THIS AGREEMENT ARE EXCLUSIVE. IN NO EVENT, REGARDLESS OF THE FORM OF THE CLAIM OR CAUSE OF ACTION (WHETHER BASED IN CONTRACT, INFRINGEMENT, NEGLIGENCE, STRICT LIABILITY, OTHER TORT OR OTHERWISE), SHALL SELLER'S LIABILITY TO BUYER AND/OR ITS CUSTOMERS EXCEED THE PRICE TO BUYER OF THE SPECIFIC GOODS MANUFACTURED OR SERVICES PROVIDED BY SELLER GIVING RISE TO THE CLAIM OR CAUSE OF ACTION. BUYER AGREES THAT IN NO EVENT SHALL SELLER'S LIABILITY TO BUYER AND/OR ITS CUSTOMERS EXTEND TO INCLUDE INCIDENTAL, CONSEQUENTIAL OR PUNITIVE DAMAGES. THE TERM "CONSEQUENTIAL DAMAGES" SHALL INCLUDE, BUT NOT BE LIMITED TO, LOSS OF ANTICIPATED PROFITS, REVENUE OR USE AND COSTS INCURRED INCLUDING WITHOUT LIMITATION FOR CAPITAL, FUEL AND POWER, AND CLAIMS OF BUYER'S CUSTOMERS.

7. PATENTS: Subject to the limitations contained in Section 6, Seller shall defend any suits brought against Buyer based on a claim that use of the Goods manufactured by Seller constitutes an infringement of a valid patent of the United States, and shall pay any damages awarded therein against Buyer, provided that Buyer: promptly notifies Seller in writing of the

filing of such suit or the threat thereof, permits Seller to control completely the defense or compromise of such claim of infringement; and provides all reasonable assistance and cooperation requested by Seller for the defense of such suit. In the event that only the Goods manufactured by Seller are held to be infringing in such suit and their use is enjoined, Seller shall, at its sole option and expense, provide a commercially reasonable alternative, including, but not limited to, procuring for Buyer the right to continue using the Goods, replacing them with a non-infringing product or modifying them so they become non-infringing. Buyer agrees that Seller shall not be liable for infringement, and that Buyer shall fully indemnify Seller therefore, if infringement is based upon the use of Goods in connection with goods not manufactured by Seller or in a manner for which the Goods were not designed by the Seller or if the Goods were not designed by the Seller or if the Goods were designed by the Buyer or were modified by or for the Buyer in a manner to cause them to become infringing.

8. TAXES: Any tax or governmental charge payable by the Seller because of the manufacture, sale or delivery of the Goods, or provision of Services, may at Seller's option be added to the price herein specified. The foregoing shall not apply to taxes based upon Seller's net income.

9. TERMS OF PAYMENT: Subject to the approval of Seller's Credit Department, terms are F.O.B. shipping point, net 30 days from date of Seller's invoice in U.S. currency, except for applicable milestone payments covered below or export shipments for which Seller may require other arrangements. Freight charges may include shipping and handling charges, and Buyer shall pay all such charges. If any payment owed to Seller hereunder is not paid when due, it shall bear interest at a rate 1-1/2% per month interest from the date on which it is due until it is received and future shipments may be placed on hold. Seller shall have the right, among other remedies, either to terminate the Agreement or to suspend further deliveries under this and/or other agreements with Buyer in the event Buyer fails to make any payment hereunder when due. Buyer shall be liable for all expenses attendant to collection of past due amounts, including attorneys' fees. Unless otherwise provided in Seller's written quotation, periodic milestone payments shall be made by Buyer when the purchase price of this Agreement exceeds \$100,000. In such cases, invoices shall be issued by Seller and paid by Buyer based on the following milestones: Milestone 1: 30% of price upon acceptance of order by Seller. Milestone 2: 30% of price upon release by Seller of approved bills of material to manufacturing for assembly. Milestone 3: 40% of price upon shipment of the Goods by Seller. Seller reserves the right to designate additional Milestones where the Agreement provides for Services in excess of \$50,000.

10. SOFTWARE AND FIRMWARE: Notwithstanding any other provision herein to the contrary, Seller or applicable third party owner shall retain all rights of ownership and title in its respective firmware and software, including all copyrights relating to such firmware and software and all copies of such firmware and software. Except as otherwise provided herein, Buyer is hereby granted a nonexclusive, royalty free license to use firmware and software, and copies of firmware and software, incorporated into the Goods only in conjunction with such Goods and only at the Buyer's plant site where the Goods are first used. Buyer may negotiate with Seller separate licenses to use such copies and firmware and software at other plant sites. Buyer's use of certain firmwares (as specified by Seller) and all other software shall be governed exclusively by Seller's and/or third party owner's applicable license terms.

11. BUYER SUPPLIED DATA: To the extent that Seller has relied upon any specifications, information, representation of operating conditions or other

data or information supplied by Buyer to Seller ("Data") in the selection or design of the Goods and/or provision of the Services and the preparation of Seller's quotation, and in the event that actual operating conditions or other conditions differ from those represented by Buyer and relied upon by Seller, any warranties or other provisions contained herein which are affected by such conditions shall be null and void.

12. EXPORT/IMPORT: Buyer agrees that all applicable import and export control laws, regulations, orders and requirements, including without limitation those of the United States and the European Union, and the jurisdictions in which the Seller and Buyer are established or from which items may be supplied will apply to its receipt and use of Goods and Services. In no event shall Buyer use, transfer, release, import, export, or re-export Goods in violation of such applicable laws, regulations, orders, or requirements.

13. GENERAL PROVISIONS: (a) Buyer shall not assign its rights or obligations under the Agreement without Seller's prior written consent; (b) there are no understandings, agreements or representations, express or implied, not specified in the Agreement; (c) no action, regardless of form, arising out of transactions under the Agreement, may be brought by either party more than two years after the cause of action has accrued; (d) any modification of these terms and conditions must be set forth in a written instrument signed by a duly authorized representative of Seller; (e) the Agreement is formed and shall be construed, performed and enforced under the laws of the State of Missouri (however, Buyer and Seller agree that the proper venue for all actions arising under the Agreement shall be only in the State where the Goods involved in such actions were manufactured; (f) The 1980 United Nations Convention on Contracts for the International Sale of Goods does not apply to this Agreement; (g) if any provision of the Agreement is invalid under any statute or rule of law, such provision, to that extent only, shall be deemed to be omitted without affecting the validity of the remainder of the Agreement; (h) Seller specifically objects to the application of any Federal Acquisition Regulation ("FAR") or other governmental procurement provision or clause to the Agreement; (i) UNLESS OTHERWISE SPECIFICALLY PROVIDED IN SELLER'S QUOTATION, GOODS AND SERVICES HEREUNDER ARE NOT INTENDED FOR USE IN ANY NUCLEAR OR NUCLEAR RELATED APPLICATIONS. Buyer (i) accepts Goods and Services in accordance with the restriction set forth in the immediately preceding sentence, (ii) agrees to communicate such restriction in writing to any and all subsequent purchasers or users and (iii) agrees to defend, indemnify and hold harmless Seller from any and all claims, losses, liabilities, suits, judgments and damages, including incidental and consequential damages, arising from use of Goods and Services in any nuclear or nuclear related applications, whether the cause of action be based in tort, contract or otherwise, including allegations that the Seller's liability is based on negligence or strict liability; (j) The rights, remedies and protections afforded to Seller under this Agreement, including but not limited to indemnification of Seller, limitation of remedy and liability and limited warranty shall extend to Seller and to its affiliates, subsidiaries, or related companies performing or supplying work, services, or products under this Agreement or any agreement into which it is incorporated by reference; and (k) Seller does not agree to: (i) indemnify Buyer; or (ii) name Buyer as an additional insured.



Visit www.topworx.com for comprehensive information on our company, capabilities, and products – including model numbers, data sheets, specifications, dimensions, and certifications.

info.topworx@emerson.com

www.topworx.com



The Emerson logo is a trademark and service mark of Emerson Electric Co. ©2014 Emerson Electric Co. ©2014 TopWorx. All rights reserved. TopWorx, Valvetop, GO Switch, and Leverless Limit Switch are all trademarks of TopWorx. All other marks are the property of their respective owners. Information herein – including product specifications – is subject to change without notice.

GLOBAL SUPPORT OFFICES

Americas
TopWorx
3300 Fern Valley Road
Louisville, Kentucky 40213 USA
+1 502 969 8000

Europe
Horsfield Way
Bredbury Industrial Estate
Stockport SK6 2SU
United Kingdom
+44 0 161 406 5155

Middle East
P.O. Box 17033
Jebel Ali Free Zone
Dubai 17033
United Arab Emirates
+971 4 811 8283

Africa
24 Angus Crescent
Longmeadow Business Estate
East
Modderfontein
Gauteng
South Africa
+27 011 451 3700

Asia-Pacific
1 Pandan Crescent
Singapore 128461
+65 6891 7550