



E FAMILY



QUICK INDEX

Basic Features Page 3

Valve Types — Series See Chart Below



	Page 10	Page 13	Page 16	Page 18	Page 22	Page 23
Series	EZ	E5	E4	E	E3	E* QE
Description	Compact Direct Acting	Compact Direct Acting	Compact Direct Acting	Medium Flow Direct Acting	High Flow Direct Lift	High Flow
Pressure Range	vacuum to 250 psi (17 bar)	vacuum to 500 psi (34 bar)	vacuum to 500 psi (34 bar)	vacuum to 500 psi (34 bar)	0-150 psi (10.3 bar)	5-150 psi (0.3-10.3 bar)
Flow Range	.06 to 79	.022 to 23	.022 to 23	0.026 to 0.106	0.11 to 0.16	0.06- 0.106 Inlet 3.3-8.8 Exhaust
Port Size NPT	1/8" NPT	1/8" - 1/4" NPT	1/8" - 1/4" NPT	1/8" - 1/4" NPT	1/4" NPT	1/4"-1/2" NPT Inlet 3/8"-3/4" NPT Exhaust
Nominal Power	10 AC watt 10.5 DC watt	6 - 8.5 AC watt 7-10 DC watt	0.85 - 1.8 watt	6 - 8.5 AC watt 7-10 DC watt	0.85 - 1.8 watt	0.85 - 7.2 Watt
Seals	NBR-Nitrile (Buna N) FKM (fluorocarbon) Optional		FKM (fluorocarbon)	NBR-Nitrile (Buna N)	FKM (fluorocarbon)	

Materials, General Purpose

Side Port	Aluminum	Page 10	—	—	—	—	—
	Stainless Steel	—	Page 13	—	Page 18	—	Page 23
Manifold Mount	Aluminum	Page 12	—	—	Page 20	—	—
	Stainless Steel	Consult Factory	—	—	Consult Factory	—	—

Materials, Hazardous Location

Side Port	Aluminum	—	—	—	—	—	—
	Stainless Steel	—	Page 14	Page 16	Page 18	Page 22	Page 23
Manifold Mount	Aluminum	—	—	—	Page 20	—	—
	—	—	—	—	—	—	—

Selector Page 4

Options Page 4

Solenoid options - Non Hazardous Location Page 8

Solenoid options - Hazardous Locations Page 6

Solenoid - Cross Reference Chart Page 9

The E Family

Versa's E-Series valves are 2 port, 2 position and 3 port, 2 position direct acting pneumatic and hydraulic valves consisting of two body types, side ported and manifold mounted.

E Series Side-Ported valves are individually mounted with body port sizes 1/8" NPT to 1/4" NPT.

Manifold Mounting valve is direct solenoid actuated and is mounted on a manifold which can have 1 to 10 valve stations. The manifolds are provided with the threaded ports for pipe connections, which allows the valves to be easily and swiftly installed or removed without breaking any pipe connections. The manifolds also provide common ports, such as the inlet and exhaust, making only one such connection necessary per manifold.

Design for Reliability, Flexibility and Availability

Direct Acting Solenoid Design

The E Family of solenoid valves utilize a high performance solenoid direct acting for the perfect balance of flow vs. power. Valves designed for complete pressure range including vacuum.

Electrical Connections

The E Family of solenoid valves offer the widest range of electrical hook connections, from 1/2" conduit to spade terminals and everything in between. All designed to simplify installation and serviceability. Select E Family valves are offered for hazardous location service, should application require such.

Porting Options

E Family valves are available with 1/8" or 1/4" ports for ease of installation. Select Families are available in manifolded configurations for ease of installation, space savings and trouble free maintenance.

Vent Options

The standard E Family valve is offered with a threaded vent port. This supports piped exhaust for gases and hydraulic applications. Other vent options are offered to keep contaminants out of the valve for long trouble, free service.

High Heat Epoxy Molded Coils

The E Family solenoid's are high heat rated and are all epoxy molded. A Versa standard! The epoxy molded coil yield a moisture resistance design which also dissipates heat for elevated temperature applications.

High Performance Solenoid

Near frictionless direct acting poppet design yields positive shifting, the lowest wattage ratings and unsurpassed reliability. Life cycle ratings to 20 million cycles.

Bubble Tight Sealing

The E Family of products utilizes an elastomer sealed poppet. This design offers a bubble tight seal. Many seal materials are available to offer the greatest flexibility in application/media solutions.

Durable Materials of Construction

E Family materials are available in stainless steel or aluminum to offer the greatest flexibility in application/media solutions.



BASIC PART NUMBERING — OPTIONS

Every letter and digit in the product number of a valve has significant meaning. The product number shown below (E5SM-3201-34-A120) indicates the following:

E5SM	3	2	0	1	3	4	H2	A120
E5SM Series Solenoid, Spring Return	Three-Way	1/8" NPT	Side Ports	NC	Bottom Orifice Size	Top	Solenoid exhaust adapter	120V60 COIL

BASIC PRODUCT NUMBER

E5SM	3	2	0	1
VALVE SERIES & ACTUATION	FUNCTION: Body Style	PORT SIZE	BODY DETAILS	FLOW
E5SM E5 Series	2 Two-Way	2 1/8"NPT	0 Side Ported	1 NC (Normally Closed)
E4SM E4 Series	3 Three-Way	3 1/4" NPT	1 Manifold Mounted	2 NO (Normally Open)
ESM E Series	7 Two-Outlet (3-Way-Diverter)			
E3SM E3 Series	8 Two-Inlet (3-Way-Selector)			
EZ EZ Series, for part number selection see page 10				
EQE EQE Series, for part number selection see page 23				
E4QE EQE Series, for part number selection see page 23				
E5QE EQE Series, for part number selection see page 23				

Options

Solenoid Options	
General Purpose (see page 4)	
-243	Grommeted housing (flying leads)
-228L	Epoxy formed coil with 1/2" conduit hub, NEMA 4
-HC	DIN connector with strain relief
-HCC	DIN connector with 1/2" conduit hub
-HCL	DIN connector with light
-HCCL	DIN connector with 1/2" lighted conduit hub.
-HT	High temperature coil Class H insulation.
-P	Plug-in - A connection on manifold mounted valves that provides a plug in electrical connection
-44	Low temperature seals
-PC	Potted Coil - Ingress protection, provides NEMA 4 rating.
-Z	Exhaust vent for manifolded valves
Hazardous Service (see page 6)	
-XX	Hazardous Location solenoid, North American
-XN	Hazardous Location, coil ATEX Approvals
-LB (-XX or -XN required)	Low Watt 1.8 coil (-LX for E4SM See page 16 For E3 see page 22)
-LA (-XX or -XN required)	Low Watt 0.85 coil (-LC for E4SM See page 16 For E3 see page 22)
-HT	High temperature coil Class H insulation.
-PC	Potted Coil - Ingress protection, provides NEMA 4 rating.
-44	Low temperature seals
-ST (-XX or -XN required)	Stainless steel coil housing.
-XISC (-HC or HCC required)	Intrinsic Safe electrical operator, CSA
-XISX6 (-HC or HCC required)	Intrinsic Safe electrical operator, ATEX
-XDBS*/-XDBT*	Coil enclosure, 316 stainless steel, internal junction box with multi agency approvals (see page 16).
-XIF*	Intrinsic Safe ATEX Coil with internal junction box
-XMA*	Explosion Proof solenoid coil with integral junction box and internal bridge rectifier (see page 6)
Miscellaneous	
-14 (General purpose only)	Dust Excluder – Dust Tight; protection from contamination entering the solenoid sleeve (exhaust)
-E14	Dust Excluder – Dust Tight; protection from contamination entering the solenoid sleeve (exhaust)
-L14	Dust Excluder – Dust Tight; protection from contamination entering the solenoid sleeve (exhaust)
-D14	Dust Excluder – Water Tight; protection from "dirt or water" entering the solenoid sleeve (exhaust)
-H	1/4" npt, solenoid vent adapter (for stainless steel use -HE)
-H2	1/8" npt, solenoid vent adapter (for stainless steel use -H2E)
-WE	Mounting bracket, wall mount, attached to coil housing
-WMA	Mounting bracket, bottom mount, stainless steel,
-M	Manual override, a non-locking manual override, unguarded for solenoid actuators
-MAE	Manual override, with manual override pin that extends past the guard plate
-M5R	Manual override, an unguarded, locking, with a knurled knob, push to actuate and turn to lock.

SUFFIX DETAILS

Suffix details indicate modifications or variations to the basic valve. When specifying simply add those suffix details required in alphanumeric order.

Listed below are the suffix detail modifications found in this catalog and the page on which they are noted.

3		4		H2	A120
BOTTOM ORIFICE		TOP ORIFICE		SUFFIX DETAILS	VOLTAGE CODE
0 None (2-way NO)	0 None (2-way NC)	See Options below (Partial list)			Solenoid actuated valves require a Coil Code that indicates the specific coil current frequency and voltage. The Coil Code consists of a letter to indicate the current frequency Rating Code: A= 60Hz frequency (AC) D= Direct Current (DC) E= 50Hz frequency (AC) Examples: Voltage Code 24V60 = A024 120V60 = A120 24VDC = D024 110V50 = E110
2 1/32"	2 1/32"				
3 3/64"	3 3/64"				
4 1/16"	4 1/16"				
6 3/32"	6 3/32"				
8 1/8"					
12 3/16"					
16 1/4"					

EZ		E5SM	E4SM	ESM		E3SM	EQE		
Side Ported	Manifold Mounted	Side Ported	Side Ported	Side Ported	Manifold Mounted	Side Ported	E4QE	E5QE	EQE
X	X	X		X	X			X	X
X	X	X						X	
X	X	X		X	X			X	X
X	X	X		X	X			X	X
X	X	X		X	X			X	X
		X		X	X			X	X
		X		X	X				
	X	X		X	X			X	X
		X		X	X			X	X
		X						X	
		X		X	X			X	X
		X		X	X			X	X
		X	X	X	X			X	X
		X		X	X			X	X
		X						X	
			X				X		
				X	X				X
				X	X				X
X	X	X	X				X	X	
X	X	X	X	X	X		X	X	X
		X	X	X	X		X	X	X
X	X	X	X	X	X		X	X	X
		X	X	X					
				X	X				
				X	X				
				X	X				

SOLENOID SELECTOR General Purpose

NONHAZARDOUS LOCATION SOLENOIDS

Image	Series	Suffix Detail	Certification- (Conformance)		Ingress Protection	Voltage (Power)	Electrical Characteristics	Miscellaneous
			AC	DC				
	E5SM	Standard -PC	CSA		NEMA 1, 2, 3 & 4	24V60, 120V60, 240V60 (8W) 24V50, 110V50, 220V50 (8W) 12VDC, 24VDC, 48VDC (7W)	Class F epoxy molded coil (155°C). Continuous duty.	Steel cover with 1/2 NPT conduit entry.
	ESM	Standard -PC	CSA UL		NEMA 4; IP65	24V60, 120V60, 240V60 (7.3W) 24V50, 110V50, 220V50 (7.3W) 12VDC, 24VDC, 48VDC (9.5W)		Epoxy molded coil with integral 1/2" npt conduit hub
	EZ E5SM	-228L			NEMA 4	24V60, 120V60, 240V60 (8.5W) 24V50, 110V50, 220V50 (8.5W) 12VDC, 24VDC, 48VDC (10.5W)		Steel cover with grommited (flying) leads. 2 leads 24" (60 cm)
	E5SM	-243	CSA UL		NEMA 1, 2 & 3	24V60, 120V60, 240V60 (8W) 24V50, 110V50, 220V50 (8W) 12VDC, 24VDC, 48VDC (7W)		Steel cover with grommited (flying) leads 2 leads 24" (60 cm)
	ESM		CSA UL		NEMA 1, 2 & 3	24V60, 120V60, 240V60 (7.3W) 24V50, 110V50, 220V50 (7.3W) 12VDC, 24VDC, 48VDC (9.5W)		flying leads. 2 leads 24" (60 cm)
	EZ		— —		NEMA 1, 2 & 3	24V60, 120V60, 240V60 (8.5W) 24V50, 110V50, 220V50 (8.5W) 12VDC, 24VDC, 48VDC (10.5W)		Spade terminals (3). Connector: mini DIN socket with PG9 cable gland.
	EZ E5SM	-HC	CSA UL	—	NEMA 4	24V60, 120V60, 240V60 (8.5W) 24V50, 110V50, 220V50 (8.5W) 12VDC, 24VDC, 48VDC (10.5W)		Spade terminals (3) Connector pins according to Din 43650 & ISO 4400
	ESM		— —	— —	IP 65	24V60, 120V60, 240V60 (12W) 24V50, 110V50, 220V50 (12W) 12VDC, 24VDC, 48VDC (10W)		Spade terminals (3). Connector: mini DIN socket with PG9 cable gland.
	EZ E5SM	-HCL	CSA UL	—	NEMA 4	24V60, 120V60, 240V60 (8.5W) 24V50, 110V50, 220V50 (8.5W) 12VDC, 24VDC, 48VDC (10.5W)		Spade terminals (3). Connector: mini DIN socket with PG9 cable gland.
	ESM		— —	— —	IP 65	24V60, 120V60, 240V60 (12W) 24V50, 110V50, 220V50 (12W) 12VDC, 24VDC, 48VDC (10W)		Spade terminals (3). Connector: mini DIN socket with PG9 cable gland.
	EZ E5SM	-HCC	CSA UL	—	NEMA 4	24V60, 120V60, 240V60 (8.5W) 24V50, 110V50, 220V50 (8.5W) 12VDC, 24VDC, 48VDC (10.5W)		Spade terminals (3). Connector pins according to Din 43650 & ISO 4400
	ESM		— —	— —	IP 65	24V60, 120V60, 240V60 (12W) 24V50, 110V50, 220V50 (12W) 12VDC, 24VDC, 48VDC (10W)		Spade terminals (3). Connector: mini DIN socket with PG9 cable gland.
	EZ E5SM	-HCCL	CSA UL	—	NEMA 4	24V60, 120V60, 240V60 (8.5W) 24V50, 110V50, 220V50 (8.5W) 12VDC, 24VDC, 48VDC (10.5W)		Spade terminals (3). Connector: mini DIN socket with PG9 cable gland.
	ESM		— —	— —	IP65	24V60, 120V60, 240V60 (12W) 24V50, 110V50, 220V50 (12W) 12VDC, 24VDC, 48VDC (10W)		Steel cover with electrical plug-in. A Solenoid which can be removed from subplate or manifold, without disturbing the wiring
	ESM	-P	—	—	NEMA 4; IP65	24V60, 120V60, 240V60 (12W) 24V50, 110V50, 220V50 (12W) 12VDC, 24VDC, 48VDC (10W)		

SERIES EZ

Side Ported Types

Series EZ valves are direct solenoid actuated valves and, physically, are the smallest of the Series E type valves. Ports are 1/8" NPT in the valve body and are individually mounted. See below for technical data.

Series EZ Bantam Multiple Manifold valves are direct solenoid actuated and have 2 to 10 valve cavities within a single body. Each valve within the manifold must be the same and perform the same function. See page 12 for part number example.

<u>Functional Types Available</u>	<u>Ports Provided</u>
2-way, NC or NO.....	Common inlet, individual outlets
3-way, NC.....	Common inlet, individual outlets, exhaust to atmosphere. Common exhaust is available.
3-way, NO.....	Common inlet & exhaust, individual outlets
Multipurpose.....	Individual "NC," "COM," & "NO" ports

Function	2-Way NC, 2-way NO, 3-way NC, 3-Way NO, Directional & Multi-Purpose
Media	Air
Pressure:	Vacuum - 500
Flow:	to 0.21 Cv
Temperature:	0°F (-18°C) to 180°F (82°C)
Ports, Inlet & Outlet:	1/8" NPT
Exhaust/vent:	Vent to atmosphere, #10-32 thread (NPT port or dust protectors available)
Voltages:	AC or DC (see selector table)
Coil rating:	Class F, continuous duty
Power:	8.5 - 10 .5 Watts
Connections:	DIN standard (-HC), Flying Leads (-243) or 1/2" NPT conduit Hub (-228L) optional
Ingress protection:	IP65 (-HC), NEMA 1 - 3 (-243), NEMA 4 (-228L)
Materials of construction:	
Seals:	FKM (fluorocarbon)
Body:	Aluminum
Manifold:	Aluminum
Coil:	Epoxy molded, Class F, continuous duty
Mounting:	(2) threaded holes



Shown with
-HC, -H2



Shown with
-243

1/2" NPT Conduit Hub

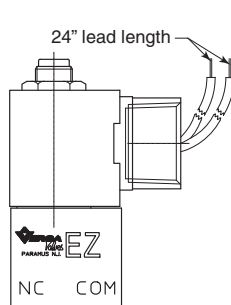

DIN with PG-9 Cord Grip

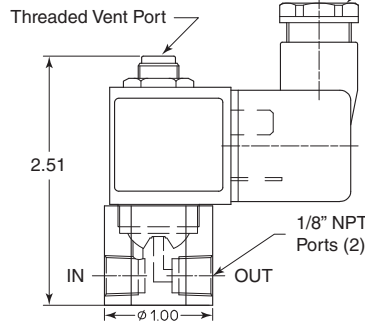

Flying Leads

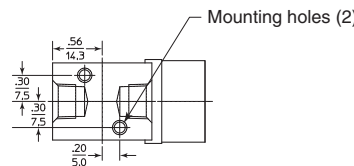
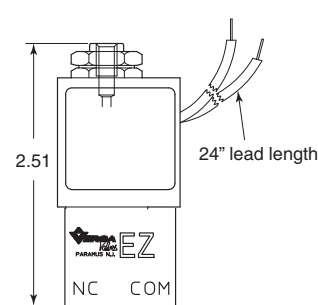

Orifice & Cv Data			
Orifice	Cv	Orifice	Cv
1/32"	0.022	1/8"	0.26
3/64"	0.06	5/32"	0.45
1/16"	0.106	3/16"	0.56
3/32"	0.21	1/4"	0.79

(STANDARD DIN STYLE COIL & CONNECTOR)

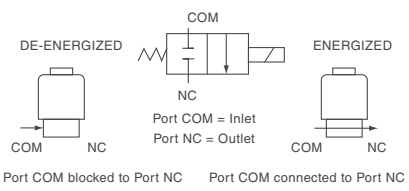
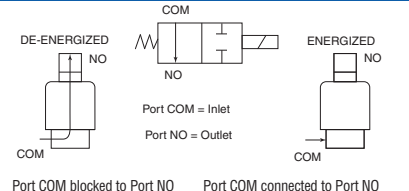
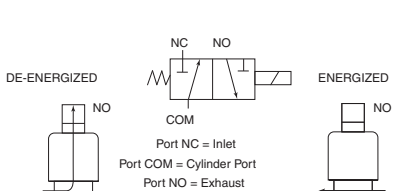
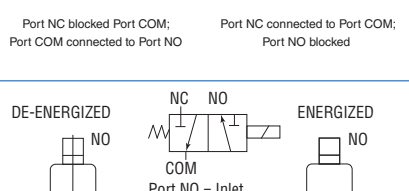
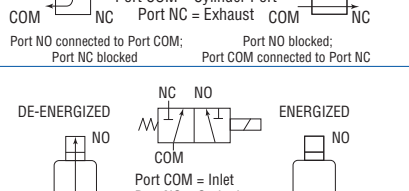
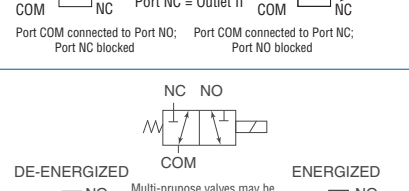
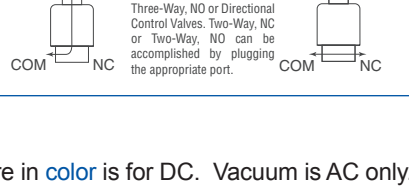
SIDE PORTED VALVES					
Type	Maximum Operating Pressure Differential ¹ psi (bar)	Product Number with Micromini DIN Style Connector (8 mm gap). For other housing options see page 8.	Minimum Orifice between Ports		Piping Arrangement and Flow Pattern
			"NC" - "COM"	"COM" - "NO"	
TWO-WAY 2/2 NORMALLY CLOSED Air, Oil or Water	500 (34) 400 (27) 200 (14) 150-100 (10-6.8) 65-45 (4.4-3.1)	EZ-2220-0-HC-(*) EZ-2230-0-HC-(*) EZ-2240-0-HC-(*) EZ-2260-0-HC-(*) EZ-2280-0-HC-(*)	1/32" (0.8 mm) 3/64" (1.2 mm) 1/16" (1.6 mm) 3/32" (2.4 mm) 1/8" (3.2 mm)		 <p>DE-ENERGIZED ENERGIZED</p> <p>COM NC COM NC</p> <p>Port COM = Inlet Port NC = Outlet</p> <p>Port COM blocked to Port NC Port COM connected to Port NC</p>
TWO-WAY 2/2 NORMALLY OPEN Air, Oil or Water	400 (27) 200 (14) 125 (8.6) 40 (2.7)	EZ-2102-H2-HC-(*) EZ-2103-H2-HC-(*) EZ-2104-H2-HC-(*) EZ-2106-H2-HC-(*)		1/32" (0.8 mm) 3/64" (1.2 mm) 1/16" (1.6 mm) 3/32" (2.4 mm)	 <p>DE-ENERGIZED ENERGIZED</p> <p>COM NO COM NO</p> <p>Port COM = Inlet Port NO = Outlet</p> <p>Port COM blocked to Port NO Port COM connected to Port NO</p>
THREE-WAY 3/2 NORMALLY CLOSED (EXHAUST TO ATMOSPHERE) Air Only	200 (14) 150 (10) 100 (6.9) 50 (3.4) 30 (2.1)	EZ-3122-1-HC-(*) EZ-3133-1-HC-(*) EZ-3144-1-HC-(*) EZ-3166-1-HC-(*) EZ-3186-1-HC-(*)	1/32" (0.8 mm) 3/64" (1.2 mm) 1/16" (1.6 mm) 3/32" (2.4 mm) 1/8" (3.2 mm)	1/32" (0.8 mm) 3/64" (1.2 mm) 1/16" (1.6 mm) 3/32" (2.4 mm) 3/32" (2.4 mm)	 <p>DE-ENERGIZED ENERGIZED</p> <p>COM NO COM NO</p> <p>Port NC = Inlet Port COM = Cylinder Port Port NO = Exhaust</p> <p>Port NC blocked Port COM; Port NC connected to Port COM; Port COM connected to Port NO Port NO blocked</p>
THREE-WAY 3/2 NORMALLY CLOSED (PIPED EXHAUST) Air, Oil or Water	200 (14) 150 (10) 100 (6.9) 50 (3.4) 30 (2.1)	EZ-3122-H2-HC-(*) EZ-3133-H2-HC-(*) EZ-3144-H2-HC-(*) EZ-3166-H2-HC-(*) EZ-3186-H2-HC-(*)	1/32" (0.8 mm) 3/64" (1.2 mm) 1/16" (1.6 mm) 3/32" (2.4 mm) 1/8" (3.2 mm)	1/32" (0.8 mm) 3/64" (1.2 mm) 1/16" (1.6 mm) 3/32" (2.4 mm) 3/32" (2.4 mm)	 <p>DE-ENERGIZED ENERGIZED</p> <p>COM NO COM NO</p> <p>Port NO = Inlet Port COM = Cylinder Port Port NC = Exhaust</p> <p>Port NO connected to Port COM; Port NO blocked; Port NC blocked Port COM connected to Port NC</p>
THREE-WAY 3/2 NORMALLY OPEN Air, Oil or Water	150 (10) 125 (8.6) 100 (6.9) 50 (3.4)	EZ-3222-H2-(*) EZ-3233-H2-(*) EZ-3244-H2-(*) EZ-3266-H2-(*)	1/32" (0.8 mm) 3/64" (1.2 mm) 1/16" (1.6 mm) 3/32" (2.4 mm)	1/32" (0.8 mm) 3/64" (1.2 mm) 1/16" (1.6 mm) 3/32" (2.4 mm)	 <p>DE-ENERGIZED ENERGIZED</p> <p>COM NO COM NO</p> <p>Port NO = Inlet Port COM = Cylinder Port Port NC = Exhaust</p> <p>Port NO connected to Port COM; Port NO blocked; Port NC blocked Port COM connected to Port NC</p>
DIRECTIONAL CONTROL 3/2 Air, Oil or Water	300-200 (20-14) 200-150 (14-10) 100-75 (6.9-5.2) 75-40 (5.2-2.7)	EZ-7222-H2-HC-(*) EZ-7233-H2-HC-(*) EZ-7244-H2-HC-(*) EZ-7266-H2-HC-(*)	1/32" (0.8 mm) 3/64" (1.2 mm) 1/16" (1.6 mm) 3/32" (2.4 mm)	1/32" (0.8 mm) 3/64" (1.2 mm) 1/16" (1.6 mm) 3/32" (2.4 mm)	 <p>DE-ENERGIZED ENERGIZED</p> <p>COM NO COM NO</p> <p>Port COM = Inlet Port NO = Outlet I Port NC = Outlet II</p> <p>Port COM connected to Port NO; Port COM connected to Port NC; Port NC blocked Port NO blocked</p>
MULTI-PURPOSE 3/2 Air, Oil or Water	125 (8.6) 100 (6.9) 65-50 (4.4-3.4) 25 (1.7)	EZ-8222-H2-HC-(*) EZ-8233-H2-HC-(*) EZ-8244-H2-HC-(*) EZ-8266-H2-HC-(*)	1/32" (0.8 mm) 3/64" (1.2 mm) 1/16" (1.6 mm) 3/32" (2.4 mm)	1/32" (0.8 mm) 3/64" (1.2 mm) 1/16" (1.6 mm) 3/32" (2.4 mm)	 <p>DE-ENERGIZED ENERGIZED</p> <p>COM NO COM NO</p> <p>Multi-purpose valves may be used as Three-Way, NC or Three-Way, NO or Directional Control Valves. Two-Way, NC or Two-Way, NO can be accomplished by plugging the appropriate port.</p>

NOTES:

1. Pressures are for both AC or DC coil unless two pressures are shown. In that case, the pressure in color is for DC. Vacuum is AC only.

*Specify Voltage Code # from page 5.

SERIES EZ

Manifold-Mounting

MULTIPLE MANIFOLD TYPE VALVES (2-10 VALVES)					
Type	Maximum Operating Pressure Differential ¹ psi (bar)	Product Number with Micromini DIN Style Connector (8 mm gap). For Other Options See Page 8.	Minimum Orifice Between Ports		Piping Arrangement
			"NC"- "COM"	"COM"- "NO"	
TWO-WAY, 2/2 Normally Closed with Common Inlet Air, Oil or Water	150 (10) 100 (6.8) 60 (4.1) 30 (2.1)	EZM-2130-**-0-HC-(*) EZM-2140-**-0-HC-(*) EZM-2160-**-0-HC-(*) EZM-2180-**-0-HC-(*)	3/64" (1.2 mm) 1/16" (1.6 mm) 3/32" (2.4 mm) 1/8" (3.2 mm)		"NC" port = Common Inlet for a) valves "COM" port = Individual Outlet for each valve
TWO-WAY, 2/2 Normally Open with Common Inlet Air, Oil or Water	200 (14) 125 (8.6) 40 (2.7)	EZM-2203-**-Z-HC-(*) EZM-2204-**-Z-HC-(*) EZM-2206-**-Z-HC-(*)		3/64" (1.2 mm) 1/16" (1.6 mm) 3/32" (2.4 mm)	"NO" port = Common Inlet for all valves "COM" port = Individual outlet for each valve
THREE-WAY, 3/2 Normally Closed (Exhaust to atmosphere) with Common Inlet Air Only	150 (10) 100 (6.8) 50 (3.4) 30 (2.1)	EZM-3133-**-1-HC-(*) EZM-3144-**-1-HC-(*) EZM-3166-**-1-HC-(*) EZM_3186-**-1-HC-(*)	3/64" (1.2 mm) 1/16" (1.6 mm) 3/32" (2.4 mm) 3/32" (2.4 mm)	3/64" (1.2 mm) 1/16" (1.6 mm) 3/32" (2.4 mm) 1/8" (3.2 mm)	"NC" port = Common Inlet for all valves "COM" port = Individual outlet for each valve "NO" port = Individual exhaust for each valve
THREE-WAY, 3/2 Normally Closed (Piped exhaust) with Common Inlet & Common Exhaust Air, Oil or Water	150 (10) 100 (6.8) 50 (3.4) 30 (2.1)	EZM-3133-**-Z-HC-(*) EZM-3144-**-Z-HC-(*) EZM-3166-**-Z-HC-(*) EZM-3186-**-Z-HC-(*)	3/64" (1.2 mm) 1/16" (1.6 mm) 3/32" (2.4 mm) 1/8" (3.2 mm)	3/64" (1.2 mm) 1/16" (1.6 mm) 3/32" (2.4 mm) 3/32" (2.4 mm)	"NC" port = Common Inlet for a) valves "COM" port = Individual Outlet for each valve "NO" port = Common Exhaust for all valves
THREE-WAY, 3/2 Normally Open with Common Inlet & Common Exhaust Air, Oil or Water	125 (8.6) 100 (6.8) 50 (3.4)	EZM-3233-**-Z-HC-(*) EZM-3244-**-Z-HC-(*) EZM-3266-**-Z-HC-(*)	3/64" (1.2 mm) 1/16" (1.6 mm) 3/32" (2.4 mm)	3/64" (1.2 mm) 1/16" (1.6 mm) 3/32" (2.4 mm)	"NO" port = Common Inlet for all valves "COM" port = Individual Outlet for each valve "NO" port = Common Exhaust for all valves
MULTIPURPOSE, 3/2 with Common "NC" Port (See Also Note @) Air, Oil or Water	100 (6.8) 65-50 (4.4-3.4) 25 (1.7)	EZM-8233-**-†-HC-(*) EZM-8244-**-†-HC-(*) EZM-8266-**-†-HC-(*)	3/64" (1.2 mm) 1/16" (1.6 mm) 3/32" (2.4 mm)	3/64" (1.2 mm) 1/16" (1.6 mm) 3/32" (2.4 mm)	The Function Table below lists all the possible valve functions which can be obtained by just changing the connections

NOTES:

1. Pressures are for both AC or DC coil unless two pressures are shown. In that case, the pressure shown in **color** is for DC.

*Specify Voltage Code # from page 5.

**Specify number of valve stations required, 2 thru 10.

† "NO" Port variations available

Function Table

Port	2-Way NO	2-Way NC	3-Way NO	3-Way NC	Selector	Diverter
NC	Plug	Inlet	Exhaust	Inlet	Inlet	Outlet
NO	Inlet	Plug	Inlet	Exhaust	Inlet	Outlet
COM	Outlet	Outlet	Outlet	Outlet	Outlet	Inlet

—1— "NO" valve ports are un-piped and exchange to atmosphere.

—H2— Each "NO" valve port is provided with a 1/8" NPT adapter for piping each "NO" port individually.

—Z— "NO" ports of all valves are connected to a common "NO" port in the manifold.



Orifice & Cv Data

Orifice	Cv	Orifice	Cv
1/32"	0.022	1/8"	0.26
3/64"	0.06	5/32"	0.45
1/16"	0.106	3/16"	0.56
3/32"	0.21	1/4"	0.79

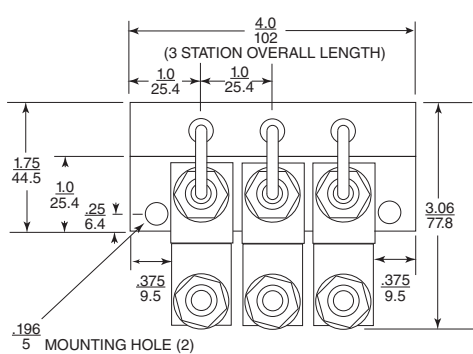

DIMENSIONS: (SHOWN IN INCH / MM)

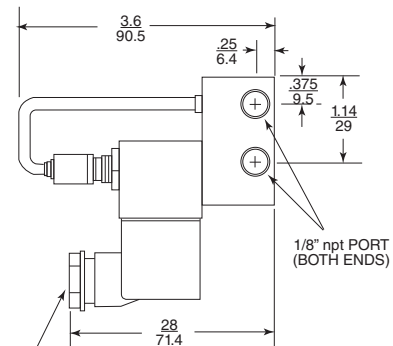
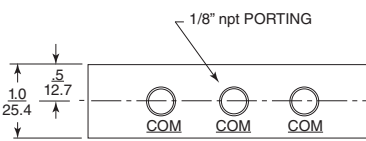

Typical Multiple Manifold

(Shows common "NO" port arrangement and micromini DIN style connector)

PG-9 CORD GRIP

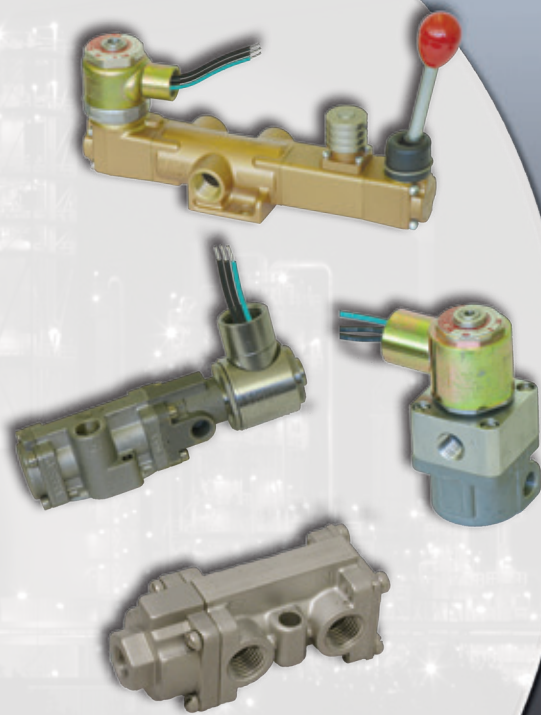

Versa has been supplying the fluid power industry with pneumatic and hydraulic components for over 50 years. We have built a reputation for quality that is unsurpassed in the market for high performance solenoids, pneumatic relays, resets and pilot valves.

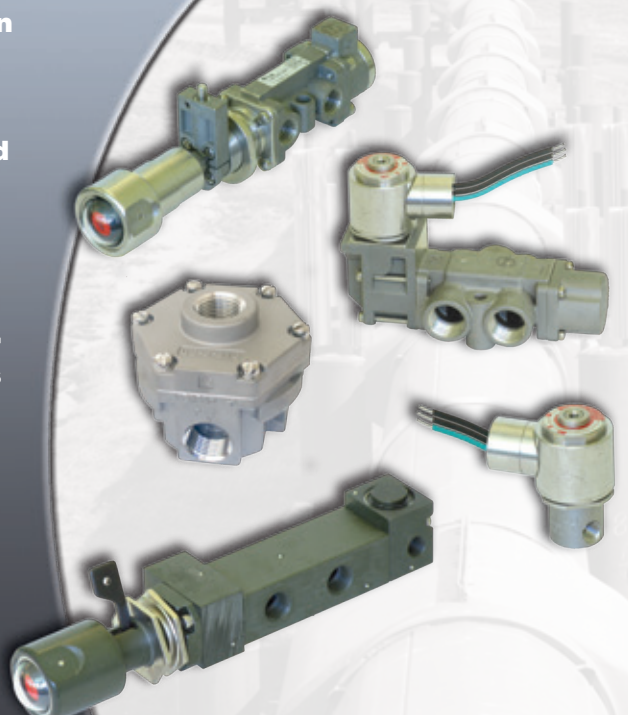

WARNINGS REGARDING THE DESIGN APPLICATION, INSTALLATION AND SERVICE OF VERSA PRODUCTS

The warnings below must be read and reviewed before designing a system utilizing, installing, servicing, or removing a Versa product. Improper use, installation or servicing of a Versa product could create a hazard to personnel and property.

DESIGN APPLICATION WARNINGS

Versa products are intended for use where compressed air or industrial hydraulic fluids are present. For use with media other than specified or for non-industrial applications or other applications not within published specifications, consult Versa.

Versa products are not inherently dangerous. They are only a component of a larger system. The system in which a Versa product is used must include adequate safeguards to prevent injury or damage in the event of system or product failure, whether this failure be of switches, regulators, cylinders, valves or any other system component. System designers must provide adequate warnings for each system in which a Versa product is utilized. These warnings, including those set forth herein, should be provided by the designer to those who will come in contact with the system.

Where questions exist regarding the applicability of a Versa product to a given use, inquiries should be addressed directly to the manufacturer. Confirmation should be obtained directly from the manufacturer regarding any questioned application prior to proceeding.

INSTALLATION, OPERATION AND SERVICE WARNINGS

Do not install or service any Versa product on a system or machine without first depressurizing the system and turning off any air, fluid, or electricity to the system or machine. All applicable electrical, mechanical, and safety codes, as well as applicable governmental regulations and laws must be complied with when installing or servicing a Versa product.

Versa products should only be installed or serviced by qualified, knowledgeable personnel who understand how these specific products are to be installed and operated. The individual must be familiar with the particular specifications, including specifications for temperature, pressure, lubrication, environment and filtration for the Versa product which is being installed or serviced. Specifications may be obtained upon request directly from Versa. If damages should occur to a Versa product, do not Operate the system containing the Versa product. Consult Versa for technical information.

LIMITED WARRANTY DISCLAIMER AND LIMITATION OF REMEDIES

Versa's Series products are warranted to be free from defective material and workmanship for a period of ten years from the date of manufacture, provided said products are used in accordance with Versa specifications. Versa's liability pursuant to that warranty is limited to the replacement of the Versa product proved to be defective provided the allegedly defective product is returned to Versa or its authorized distributor. Versa provides no other warranties, expressed or implied, except as stated above. There are no implied warranties of merchantability or fitness for a particular purpose. Versa's liability for breach of warranty as herein stated is the only and exclusive remedy and in no event shall Versa be responsible or liable for incidental or consequential damages.

Versa Products Company Inc.
22 Spring Valley Road
Paramus, New Jersey 07652
USA
Phone: 201-843-2400
Fax: 201-843-2931

Versa BV
Prins Willem Alexanderlaan
1429
7321 GB Apeldoorn
The Netherlands
Phone: 01131-55-368-1900
Fax: 01131-55-368-1909



www.versa-valves.com
email: sales@versa-valves.com